

MICROCUT



BNC-1600/1800 series

CNC Flat Bed Lathe



National Award
of Outstanding



ISO 9001:2015
FM 538421



ISO 14001:2015
EMS 546518



ISO 50001:2011
ENMS 642457

BNC-1600 / 1800 Series

MICROCUT's CNC Lathe BNC-1600 / 1800 series is specially designed for the best cutting performance, high removable rate, and great capability for turning medium size workpieces. All bearing surfaces are coated with low friction material, allowing all axes movement under minimum friction. The rigid box guideway design offers high rigidity, accuracy, durability, fast rapid feed and cutting feed as well as large loading capacity.

Ergonomic Design

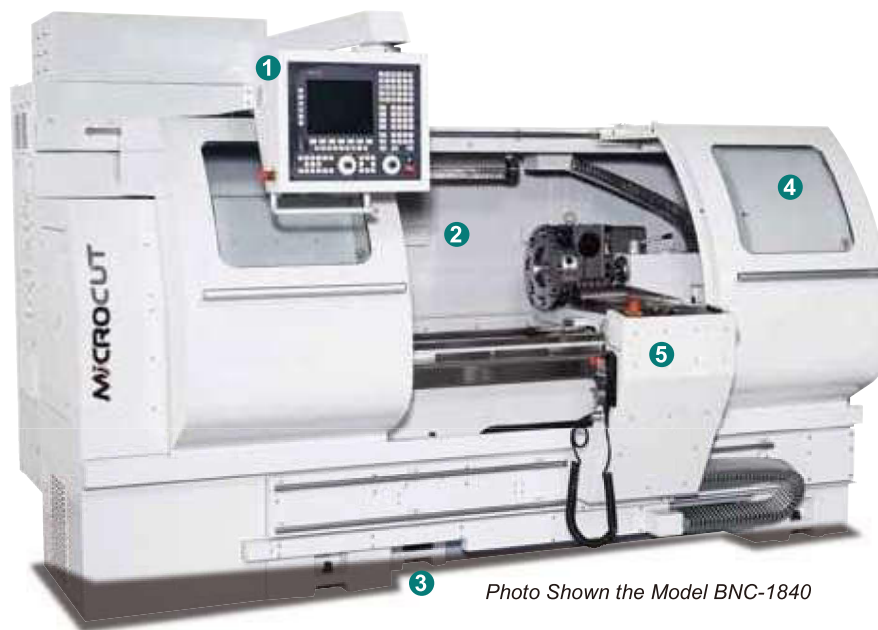

Photo Shown the Model BNC-1840

1 Eye-Level Control Panel

The swivel control panel is located at the spindle side, and the monitor position is at eye-level. The control can be used in either ISO code or conversational programming with tech-in function.

2 Spacious Rear Gate

Large gate at rear is convenient for cleaning the machine and easy access for service purpose.

3 Effortless Approaching

The gap design at the machine bottom allows the operator easy approaching the machine, which can shed the fatigue from long-hour working. Moreover, the operator can stand near the spindle center line for easy loading/unloading the workpiece.

4 Extensive Window

The enlarged window is designed for better visibility of the working area. The outer and inner layers of the window are made from Polycarbonate and safety glass which ensure the operating secureness.

5 Portable MPG & Handwheel

Portable MPG (opt.) and handwheel (opt.) are available for easy operation.



Highlights

- High spindle speed and torque: BNC-1600 is with a single high speed of 5000rpm; BNC1800 built with Automatic spindle speed changer Mechanical hydraulic chuck interface
- Extra wide bed and box way design ensures machine stability
- Faster rapid feed rate of 15m/min for X/Z axes
- Long cutting length
- Gap bed for big disk turning
- Machine standard equipped with QCT, prepared for Turret to be mounted in rear side of cross slide
- Excellent chip disposal design
- User-friendly operation station
- Large windows and full opening of doors
- Easy retrofit chip conveyor
- Heavy loading tailstock
- Thread repair function



Photo Shown the Model BNC-1600



Photo Shown the Model BNC-1800

Features



Headstock & Speed Changer

Headstock

The headstock is rigid and well balanced for high speed running. An automatic speed changing system, hydraulic chuck fitting device, and bar feeder interface are available for selection.



D1-6 Spindle Nose

Spindle

- The cartridge design makes the easy spindle replacement.
- The D1-6 spindle nose is equipped with a heavy-duty chuck for quantity production.
- BNC-1600 is single spindle speed design and driven by 7.5/11kW motor.
- BNC-1800 is equipped with a pneumatic automatic spindle speed changer, keeping the machine running under full automatic mode.



Air Lifting Device for Tailstock



Longer Tailstock & Hydraulic Tailstock Quill

Air Lifting Tailstock & Hydraulic Quill

- The air lifting device is designed for lifting and moving the tailstock easily.
- In addition to the heavy loading spindle, the longer tailstock is designed for more powerful machining which is ideal for carrying heavy workpieces.
- The carriage hooker (option) is offered for easily dragging the tailstock without struggle.
- With the hydraulic tailstock quill, the operator can easily load/unload the long workpiece; also, the pressure can be adjusted according to different materials of workpieces applied.

Maximum Z-Axis Cutting Capacity



Extra Wide Box Way

On Z axis, the extra wide box way ensures the machine stability while cutting, and the double-box-way design allows the axes rapid feed up to 15M/min to save time and cost.



Meehanite Licensed Casting Bed

The bed is Meehanite licensed casting with hardness HB170~180. The rigid structure assures the vibration-free and prevents deformation from heavy duty cutting.



Gap Bed

Gap bed design is provided for big disk turning.

Chip Management



Stainless Steel Plate of Slant Design

The slant design inside the front and rear doors are provided for chips easily falling to the tank. The stainless steel plate is added to prevent scratches caused by sliding chips.



Chip Removing Hole

The slant shape chip removing holes along bed edge is provided for excellent chip disposal.



Chip Tray & Coolant Tank

The rear-side chip tray is designed for effortless cleaning, and the coolant tank is easy for roll-out.



Chip Conveyor

A selected chip conveyor with wash down system is available which offers efficient chip disposal solution.

Control

CNC controllers are available as below:

FAGOR 8055 iFL 10.4" LCD FULL KEY CONTROLLER

FANUC 0iTD with Manual Guide 0i

SIEMENS 828D BASIC



FAGOR 8055 iFL



FANUC 0iT w/ Manual Guide 0i



SIEMENS 828D BASIC

Standard Accessories

- CNC controller
- 7.5/11kW main spindle motor
- Gap bed
- Tailstock
- Fully enclosed front guarding with interlock system
- Coolant system

- Lubrication system
- Quick change tool post with 6 pcs standard tool holder
- Low 24Vac voltage circuit system
- CE declaration of conformity for EU countries
- Heat Exchanger



Built-In Heat Exchanger



CE-Marked Electric Cabinet

CE-Marked Electric Cabinet

The electric cabinet complies with all applicable EC requirements and easy to find the replacement locally. A totally sealed cabinet ensures a good quality environment for the wiring and electrical components.

Optional Accessories



Servo Turret



Hydraulic Tailstock Quill

- Chip conveyor (incl. wash down device with 5 bar high pressure tank and oil skimmer)
- Steady rest
- Follow rest
- Bar feeder
- C axis with bracking system (for BNC-1800)
- Hydarulic tailstock
- Hydraulic 3-jaw chuck, 6"/8"
- Hydraulic 3-jaw chuck, 10"(for BNC-1800)
- Manual 3-jaw chuck, 6"/8"
- Manual 3-jaw chuck, 10"(for BNC-1800)
- Turret option for BNC-1600:
 - VDI-30 servo turret, 8T (BNC-1600)
 - VDI-30 hydraulic turret, 8T (BNC-1600)
- Turret option for BNC-1800:
 - VDI-30 servo turret, 12T (BNC-1800)
 - VDI-40 servo turret, 8T (BNC-1800)
 - VDI-30 hydraulic turret, 12T (BNC-1800)
 - VDI-40 hydraulic turret, 8T (BNC-1800)
 - VDI-30 power turret, 12T (BNC-1800)
 - VDI-40 power turret, 8T (BNC-1800)

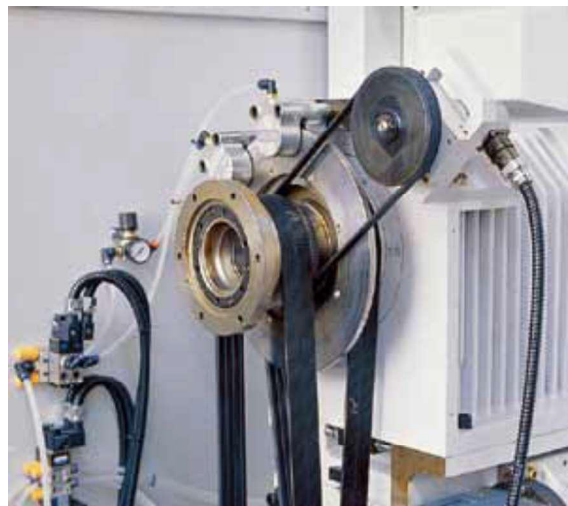

C Axis

C Axis with Braking System

(For BNC-1800 Series only)

Pneumatic braking system is provided on C axis. Bundled with the upgraded FAGOR 8055i POWER type controller and FAGOR spindle motor, the system can achieve the accuracy at 0.001°.

Various Tooling

The machine can be fitted with the quick change toolpost. Additionally, optional hydraulic turret mounted at rear position is provided and the turret position is easily adjusted on the T-slot of the cross slide.



Electrical 4-way QCT (Opt.)



Pinto Chuck (Opt.)

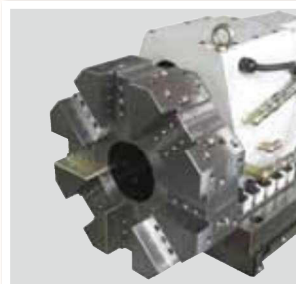

LS-160 Turret (Opt.)



Sauter Turret (Opt.)

Tooling System

BNC-1600 with LS-120 8-station turret disc (Metric-20mm tooling)

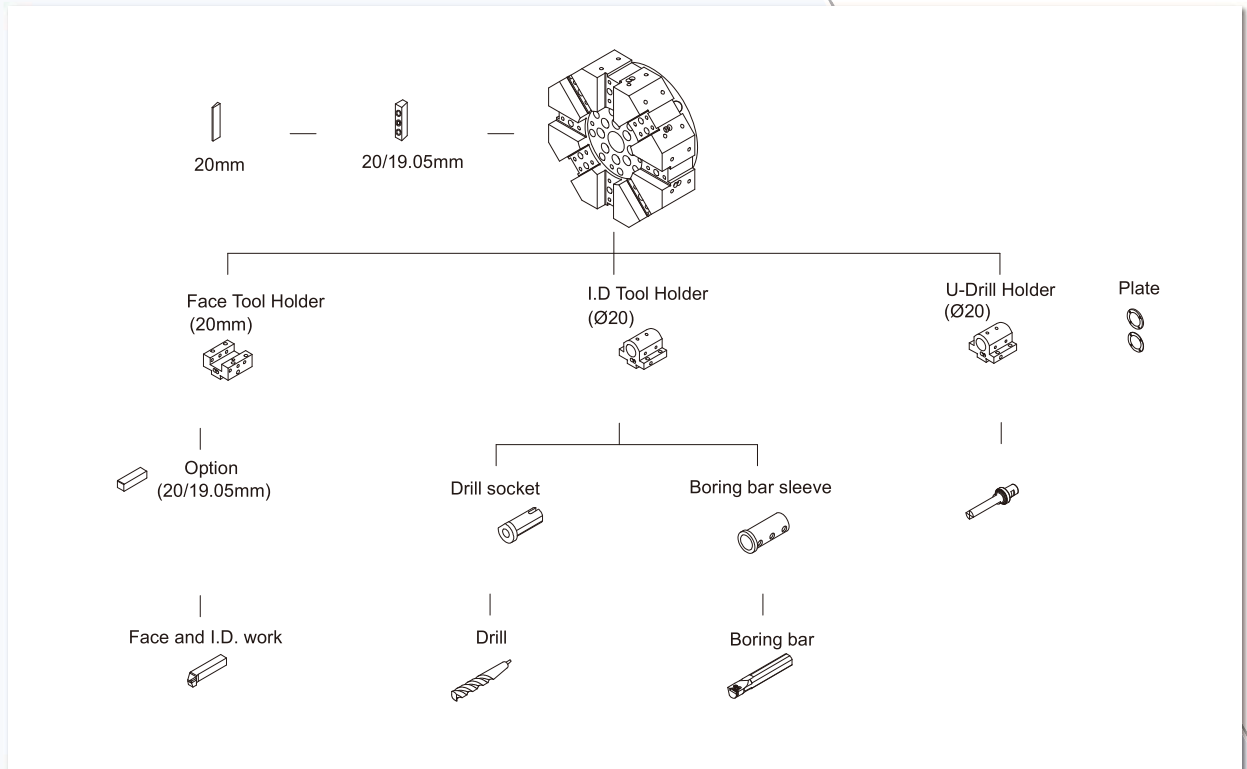

BNC-1600 with TB-120 8-station turret VDI30 disc

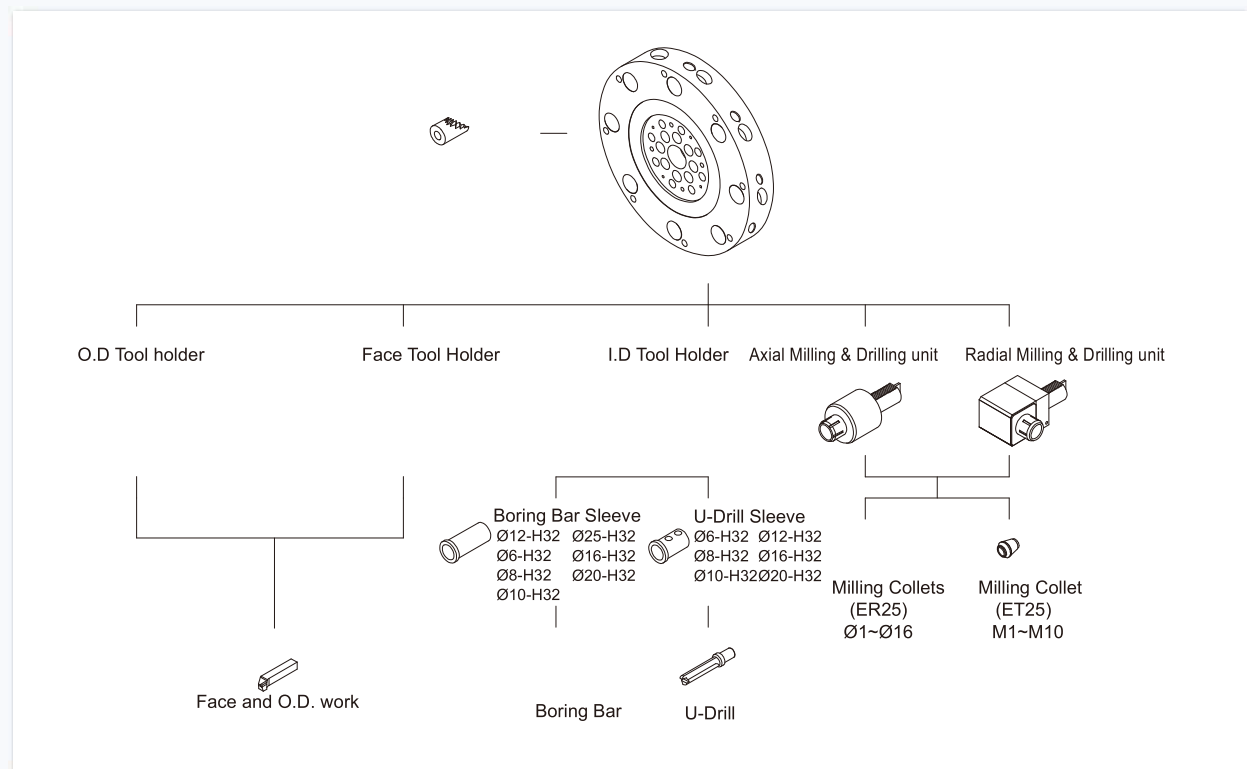

BNC-1800 with LS-160 8-station turret disc (Metric-25mm tooling)

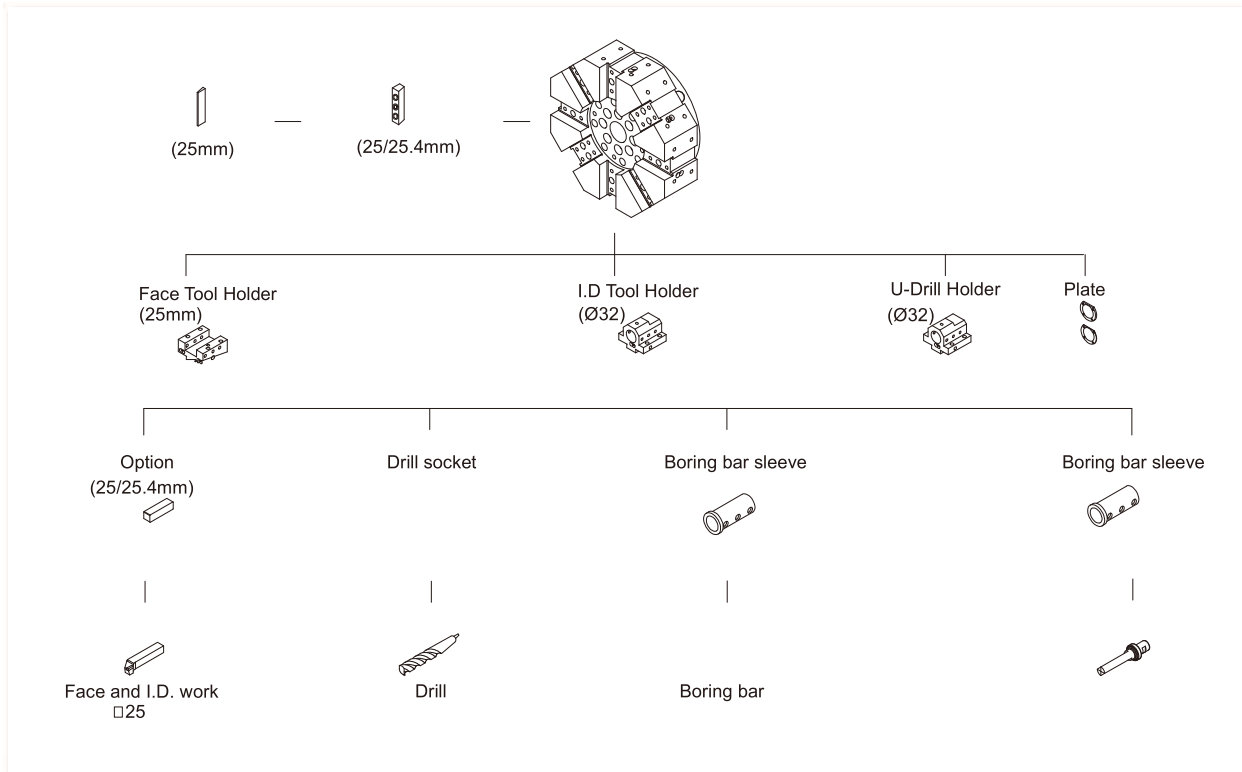

BNC-1800 with TB-160 8-station turret VDI40 disc

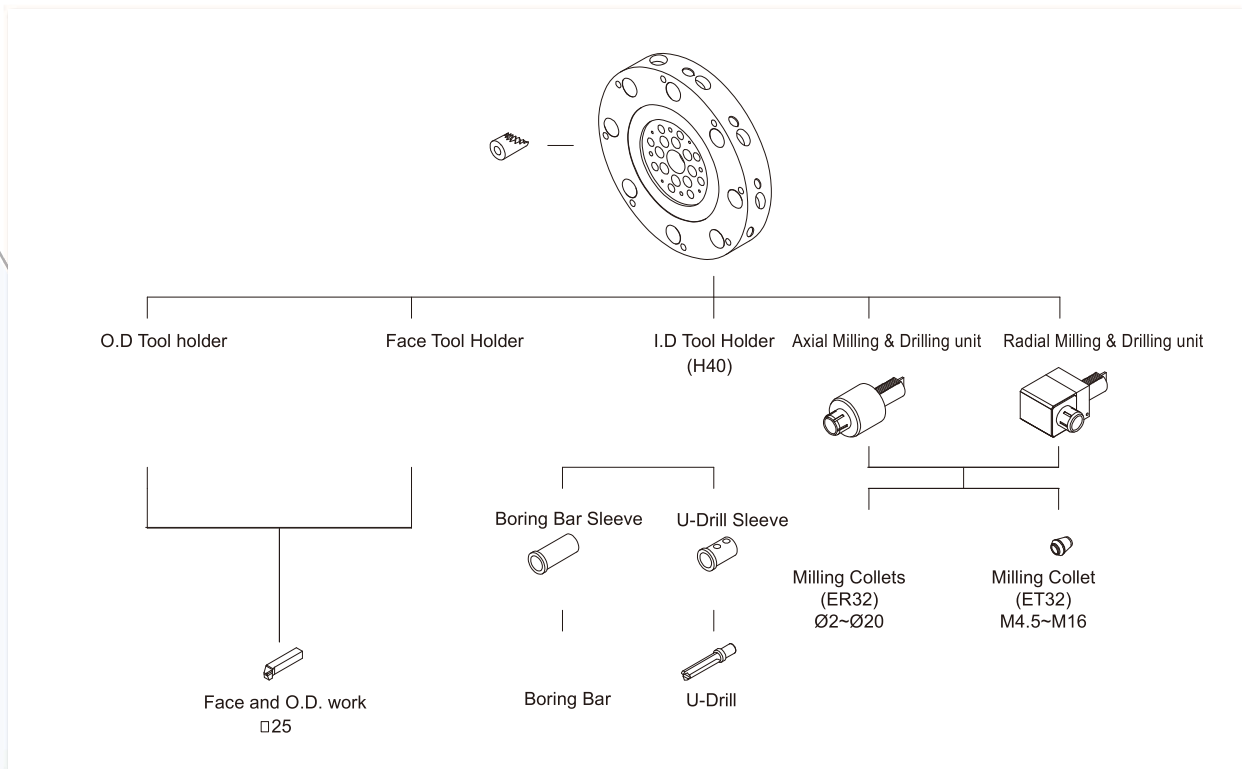

Tooling System

BNC-1800 with TB-160 12-station turret VDI40 disc

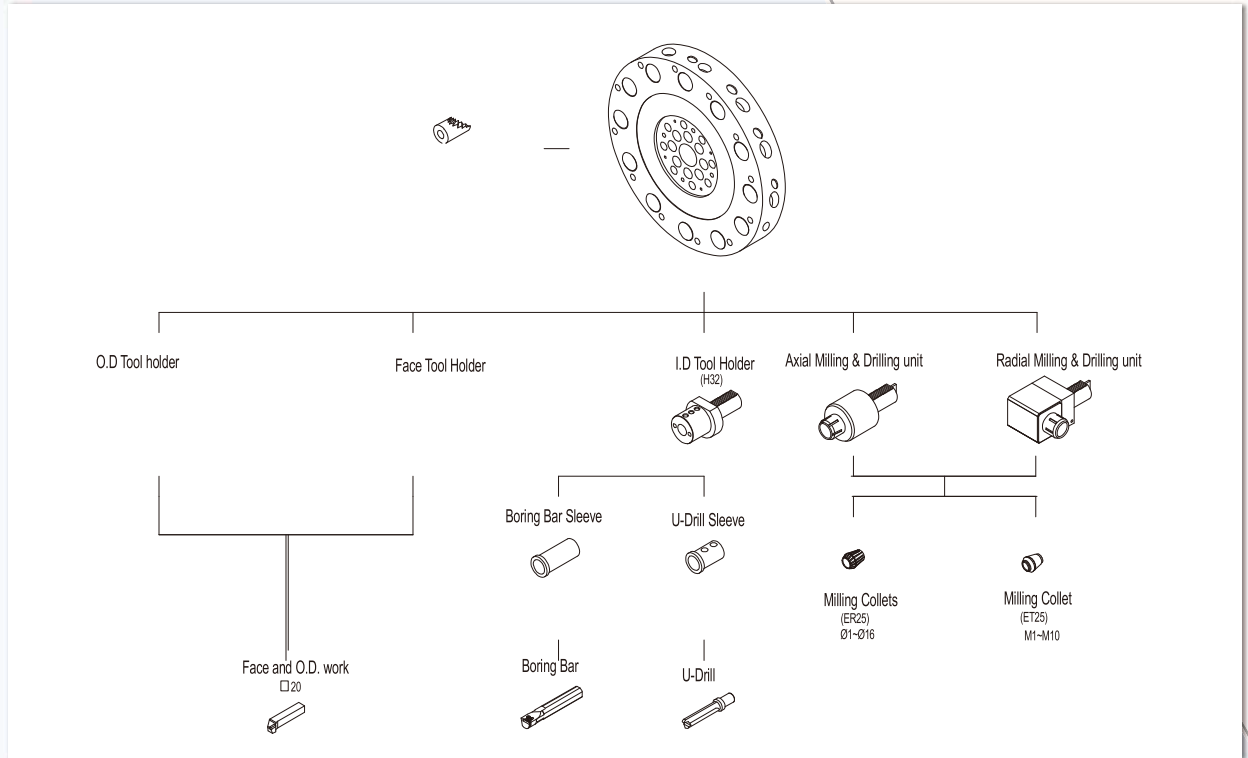

Power & Torque Chart (BNC-1600)

Fagor 7.5 / 11kW

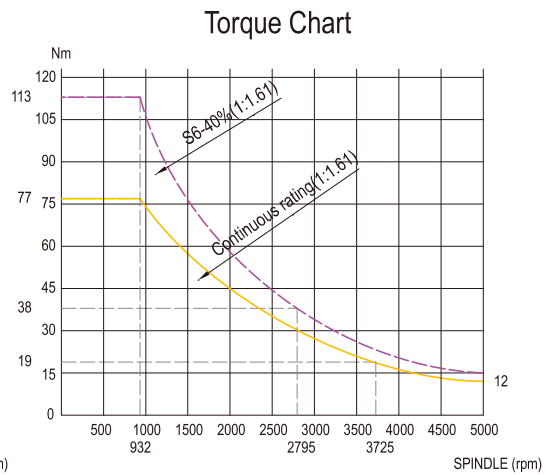
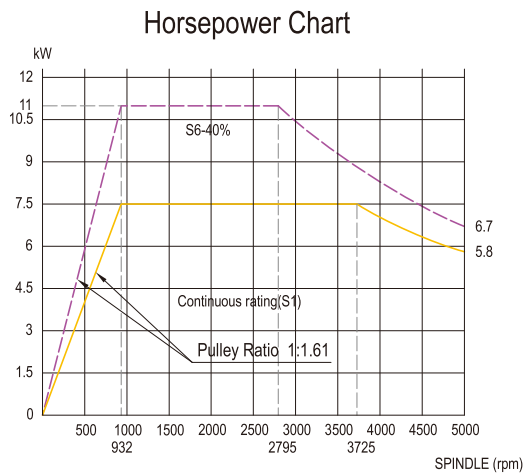

Torque / Horsepower Chart Data			
Spindle Taper	ISO	A2-5(46mm)	Spindle Motor
		-	Fagor FM7-A075/9000i
		-	Motor Output
		-	7.5/11 kw
		-	Gear Ratio
		-	-
Spindle Speed	5000 RPM	Pulley Ratio	1:1.61

Fanuc 7.5 / 11kW

Horsepower Chart

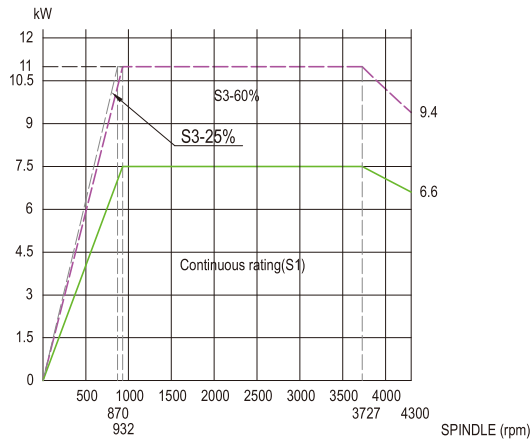

Torque Chart

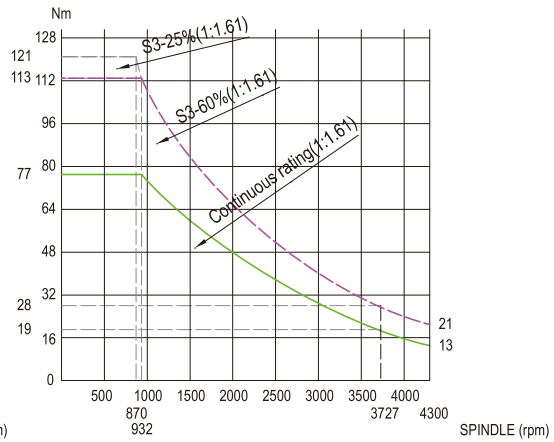

Torque / Horsepower Chart Data				
Spindle Taper	ISO	A2-5(46mm)	Spindle Motor	FANUC oil8/7000i
		-	Motor Output	7.5/11 kw
		-	Gear Ratio	-
Spindle Speed		4300 RPM	Pulley Ratio	1:1.61

(BNC-1800)

Fagor 7.5/11kW

Horsepower Chart

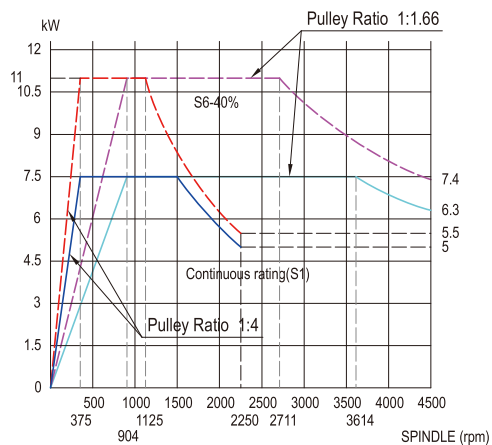

Torque Chart

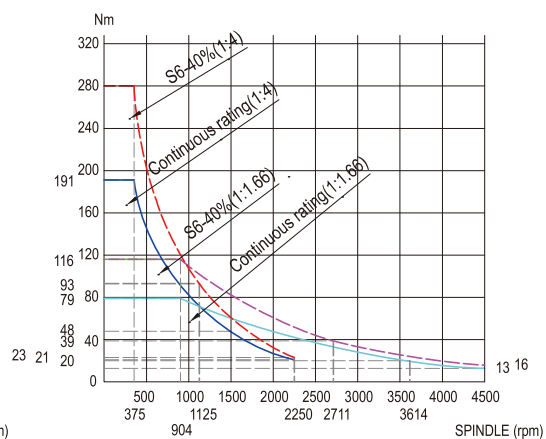

Torque / Horsepower Chart Data				
Spindle Taper	ISO	D1-6(65mm)	Spindle Motor	Fagor FM-7-A075/9000i
		-	Motor Output	7.5/11 kw
		-	Gear Ratio	-
Spindle Speed		4500 RPM	Pulley Ratio	1:4/1:1.66

Power & Torque Chart

Fagor 11/15.5kW

Horsepower Chart

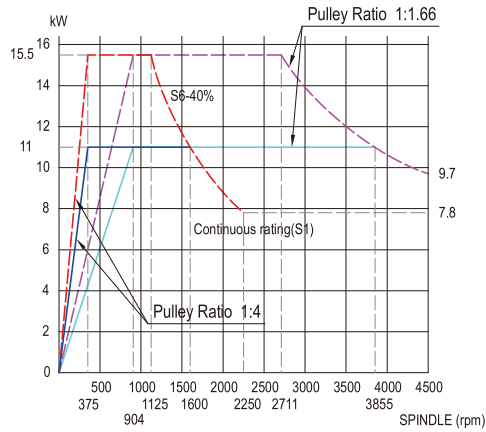

Torque Chart

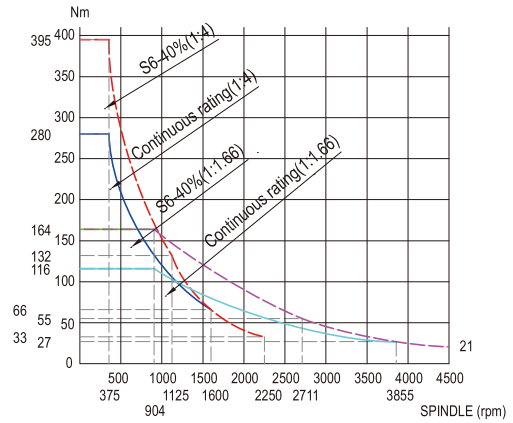

Torque / Horsepower Chart Data

Spindle Taper	ISO	D1-6(65mm)	Spindle Motor	Fagor FM-7-A110/9000i
		-	Motor Output	11/15.5 kw
		-	Gear Ratio	-
Spindle Speed		4500 RPM	Pulley Ratio	1:4/1:1.66

Fanuc 11/15kW

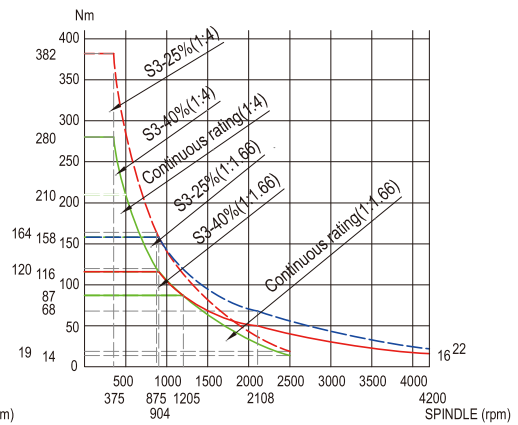
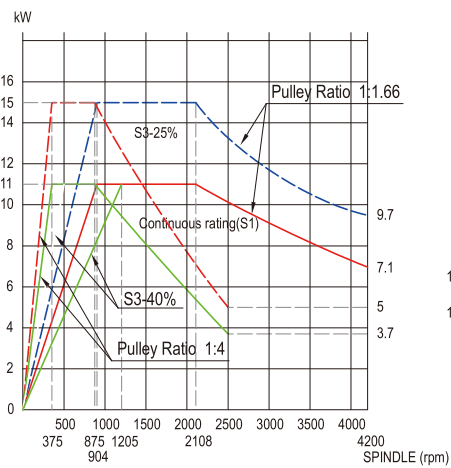

Torque / Horsepower Chart Data

Spindle Taper	ISO	D1-6(65mm)	Spindle Motor	FANUC β112/10000i
	DIN	-	Motor Output	11 / 15 kw
		-	Gear Ratio	-
Spindle Speed		4200 RPM	Pulley Ratio	1:4/1:1.66

Fanuc 15/18.5 kW

Horsepower Chart

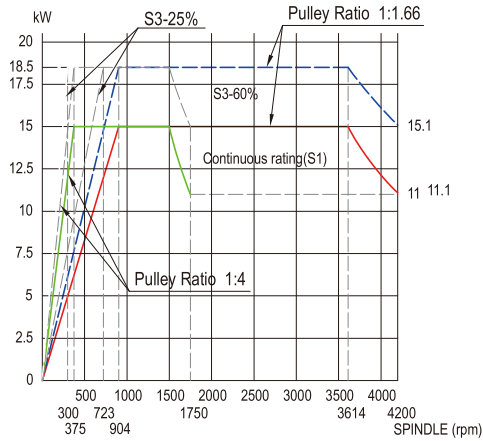

Torque Chart

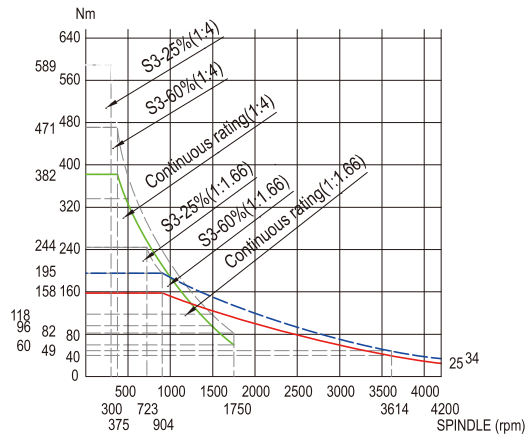

Torque / Horsepower Chart Data

Spindle Taper	ISO	D1-6(65mm)	Spindle Motor	FANUC oil15/7000i
	DIN	-	Motor Output	15 / 18.5 kw
Spindle Speed		4200 RPM	Gear Ratio	-
			Pulley Ratio	1:4/1:1.66

Siemens 11/16.5kW

Horsepower Chart

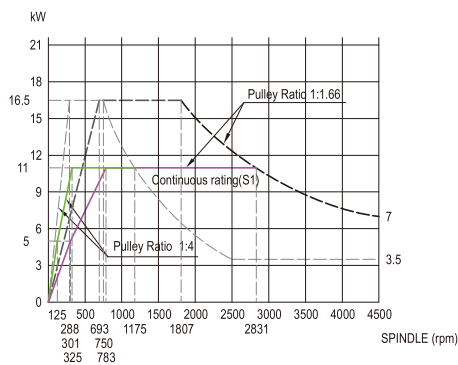

Torque Chart

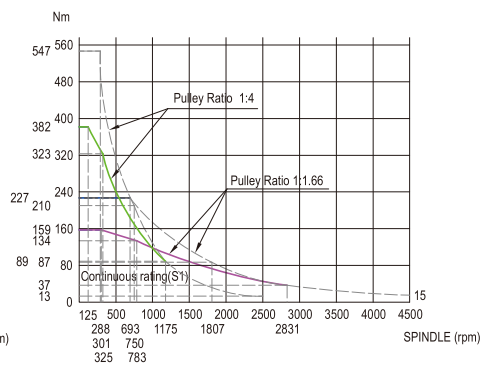

Torque / Horsepower Chart Data

Spindle Taper	ISO	D1-6(65mm)	Spindle Motor	Siemens 1PH8131-1DF02-0CA1
	DIN	-	Motor Output	11/16.5 kw
Spindle Speed		4500 RPM	Gear Ratio	-
			Pulley Ratio	1:1.66 / 1:4

Layout

BNC-1600

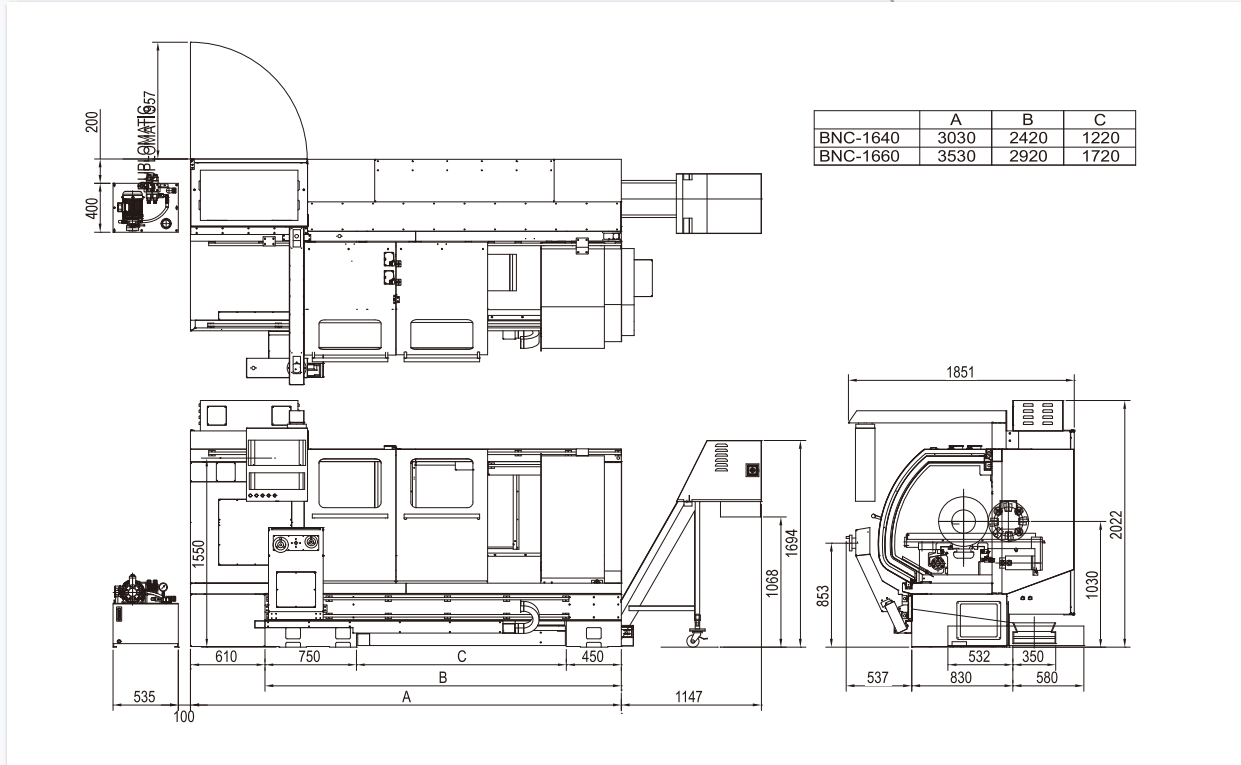

BNC-1800

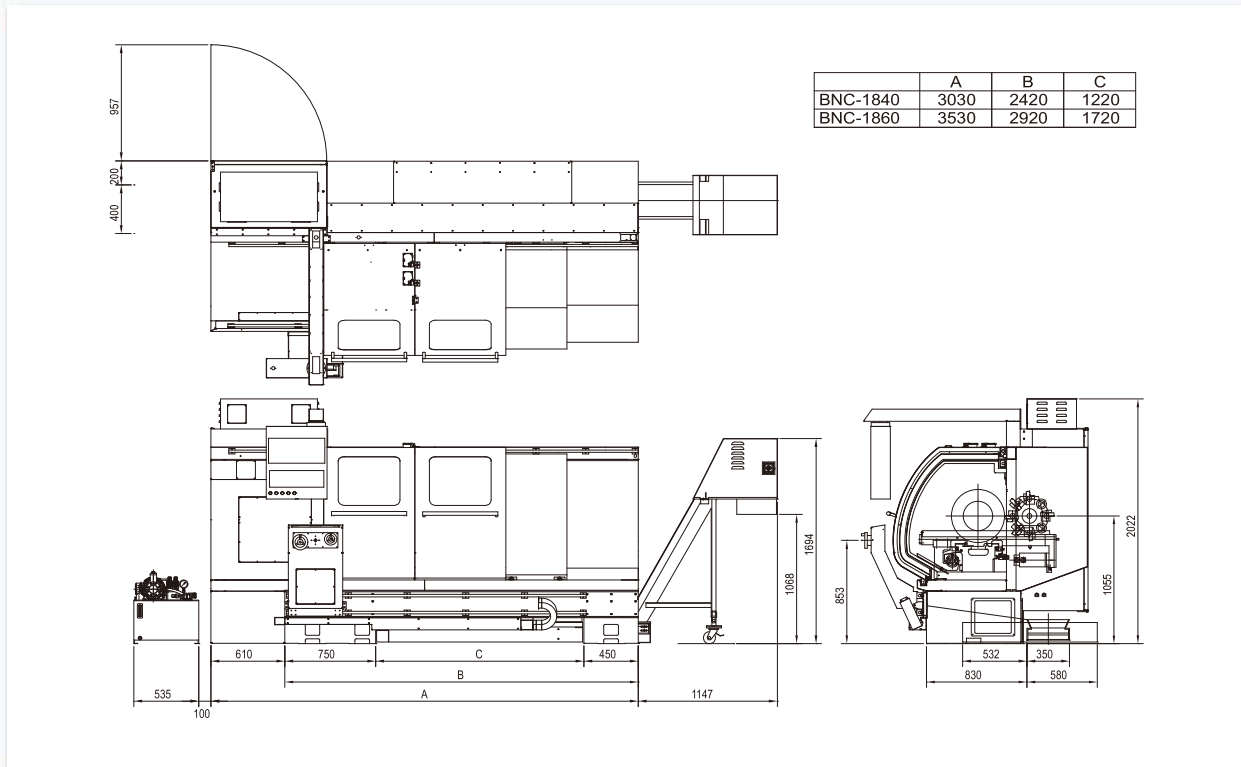

Technical Data

Item	Unit	BNC-1600	BNC-1800
Capacity			
Swing in gap	mm	660	710
Swing over bed	mm	425	475
Swing over cross slide	mm	190	240
Max. turning length (w/ turret)	mm	1000/1500	1000/1500
Max. turning length (w/ MULTIFIX)	mm	1120/1620	1120/1620
Bar capacity (hyd. chuck cylinder)	mm	37 (A2-5, 46)	44 (6" chuck) / 51 (8"-10" chuck)
Max. workpiece weight (w/ tailstock)	kg	1000	1500
Travel			
X axis	mm	260	260
Z axis	mm	1180/1680	1180/1680
Spindle			
Transmission		Belt	Belt
Speed range	rpm	Fagor/Siemens: 0-5000, Fanuc: 0-4300	Fagor/Siemens: 0-4500, Fanuc: 0-4200
Suitable chuck size (opt.)	mm	160	200
Spindle nose		A2-5	D1-6
Spindle hole diameter	mm	46	65
Motor output	kW	Fagor: 7.5/11, Fanuc: 11/15, Siemens: 11/16.5	
Transmission		Belt	
Turret (option)			
Number of tool stations		8	8
Tool allowance (square)	mm	20x20(VDI30)	25x25(VDI40)
Shank diameter for boring bar	mm	32 (VDI30)	40(VDI40)
Axes Feed Rate			
X axis rapid feed	m/min	15	15
Z axis rapid feed	m/min	15	15
Jog feed per revolution	m/min	3	3
Accuracy			
Positioning	mm	0.01/300	0.01/300
Repeatability	mm	±0.01	±0.01
Guideway			
X axis	mm	215	215
Z axis	mm	355	355
Axes Transmission			
X axis ballscrew		Ø25 x P5 x C3	
X axis transmission		Belt	
Z axis ballscrew		Ø40 x P10 x C5	
Z axis transmission		Direct	
Tailstock			
Movement		Manual	
Quill movement		Manual / Hydraulic (opt.)	
Quill stroke	mm	150	
Quill diameter	mm	65	80
Quill inside taper	MT	4	5
Coolant			
Pump motor	W	450 (50Hz) / 560 (60Hz)	
Max. pump flow	L/min	58 (50Hz) / 66 (60Hz)	
Max. pump pressure	kg/cm ²	1.5	
Lubrication			
Pump motor	W	12	
Max. pump flow	L/min	0.13	
Max. pump pressure	kg/cm ²	15	
Miscellaneous			
Length (chip conveyor excluded)	mm	3030/3530	
Length (chip conveyor included)	mm	4177/4677	
Width	mm	1952	
Height	mm	2022	
Weight	kg	2400/2850	3000/3450
Total power consumption	KVA	Fagor: 20, Fanuc: 25, Siemens: 25, Heidenhain: 20	

*Specifications are subject to change without notice.



BUFFALO MACHINERY CO., LTD.

56, Lane 318, Desheng Road, Daya District,
 Taichung City 428-46, Taiwan
 P.O. Box 320, Daya, Taichung City, Taiwan
 Tel: +886-4-25 60 37 59 Fax: +886-4-25 60 37 69
 E-mail: info@mail.buffalo.com.tw
www.buffalo-machinery.com



MICROCUT EUROPE

Ulica hrvatskih branitelja 3
 10430 Samobor CROATIA
 Tel. +385 1 3141 515
 Fax. +385 1 3141 516
info@microcut-europe.eu
www.microcut-europe.eu

