



BIAX

Professional Power

GRINDERS, FILES AND DEBURRING TOOLS PNEUMATIC TOOLS FOR INDUSTRIAL USE



Tough • Consistent • Proven



MADE IN GERMANY

Das Original

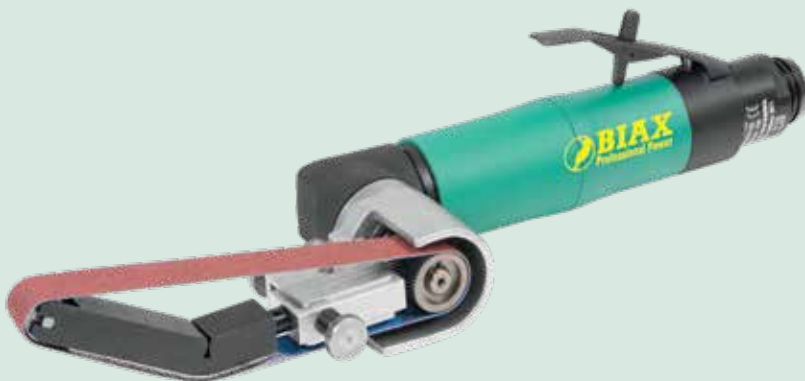

www.biax-germany.com | 001 580 301



Production hall, Maulbronn plant

For over 100 years, Schmid & Wezel has striven to provide the highest level of precision, quality and collaborative ethos.

The three divisions of the company include BIAX pneumatic and electric tools, BIAX carbide tools and EFA meat processing machinery. The tools are manufactured in three modern production sites in Germany and Switzerland.

And when it comes to product quality, Schmid & Wezel is the market leader, not least thanks to the high level of vertical integration (up to 90%).

Sustainable customer satisfaction is our goal and the most important driving force for continuous innovation and quality. The strengths of Schmid & Wezel are in providing tailored solutions in high product quality and personalised customer support.



▲ BIAX Maulbronn



▲ BIAX Hilsbach



▲ BIAX Neuhausen am Rheinflal

BIAX in-house repair service

In more than 100 years of the company's history, we have repaired countless pneumatic and electric tools. The experience and knowledge gained has been passed on from one generation of employees to the next. For our business, the repair service is an instrument of ensuring customer satisfaction. Our workshop is also fitted with special equipment made specifically for us – tools which are fully adapted to BIAX machines. Rely on us and have your repairs done directly by the manufacturer.



Here's a brief overview of our services:

- 12-month warranty
- We use only genuine BIAX spare parts of the highest quality
- Repairs are carried out by experts with many years of experience at BIAX
- We repair your standard machine at a reasonable fixed price, thus eliminating the need for a cost estimate and saving you lots of time. The average repair time is around two weeks, after which your machine will be as good as new
- Therefore, after repairs we offer a renewed warranty period of 12 months
- Goodwill – we are available to talk and can decide for the customer in case of doubt
- Repair training available on request for end customers

Other services

- On-site expert advice from our field representative or over the telephone with our in-house staff
- Specially trained in-house application consultants, providing a wide range of consultation services. These can also develop special, customised solutions for your business
- Test device: Not sure? Try out our machines free of charge and with no obligation before purchasing
- Very fast delivery times and responses to your enquiries
- Training and technical lectures
- A wide-ranging network of partners, both domestically and abroad

Schmid & Wezel is ISO-certified



Contents

	Page:
01 High-speed oil-free grinders _____	05
02 High-speed grinders _____	08
03 Straight grinders _____	14
04 Angle grinders _____	24
05 Belt sanders _____	30
06 Drilling deburrers _____	36
07 Pneumatic files _____	42
08 Brushing tools _____	50
09 Chisels and engraving tools _____	54
10 Pneumatic saws _____	56
11 Drills _____	59
12 Accessories _____	60



Maintenance-friendly, clean and super-fast – our high-speed oil-free grinders are suitable for even the most delicate deburring work.

The main advantages of oil-free pneumatic grinders are that they do not leave behind oily residues on the workpieces and they do not contaminate the exhaust air. Maintenance of these tools is also easier, since it only involves a simple air filter. Our lubrication-free machines achieve very high speeds and are therefore perfect for highly delicate deburring work using very thin rotary burs. They also offer high torque and an impressive level of performance.



01 High-speed oil-free grinders – for highly delicate deburring work

Speed [rpm]: 100,000
Power [watts]: 80



Optional accessories

Vario-holder
Order no. 007 012 848



Connection set
Order no. 007 899 115
(without hose unit)
For details, see page 61



TVD 3-100/2
Order no. 150 149 906
TVD 3-100/3 Ultra
Order no. 150 149 911



Ideal surface quality without machining marks during delicate deburring work thanks to the very high speed and elastic spindle bearings. Very quiet running and good handling due to compact dimensions.

Included accessories

Collet ZG 5 / 3 mm
Order no. 001 999 985
For other sizes, see page 61

Collet wrench, size 6+8
Order no. 007 899 751

Hose unit
Order no. 001 366 537



No oil-bearing compressed air required. Please operate at 6 bar.

01 High-speed oil-free tools – for highly delicate deburring work

Speed [rpm]: 65,000
Power [watts]: 80



Optional accessories

Vario-holder
Order no. 007 012 848



Connection set
Order no. 007 899 115
(without hose unit)
For details, see page 61



T3-65 S
Order no. 150 149 810

Highly wear-resistant tool due to the paired bearings at the front. Quiet running and pleasantly quiet during operation. Slim, ergonomic design.

Included accessories

Collet ZG 5 / 3 mm
Order no. 001 999 985
For other sizes, see page 62

Collet wrench, size 6+8
Order no. 007 899 751

Hose unit
Order no. 001 367 502



No oil-bearing compressed air required. Please operate at 6 bar.

Speed [rpm]: 85,000
Power [watts]: 100



Optional accessories

Vario-holder
Order no. 007 012 848



Connection set
Order no. 007 899 115
(without hose unit)
For details, see page 61



TSD 385
Order no. 150 001 710
TSH 385
Order no. 150 001 700

With a patented, oil-free vane motor for high-precision applications. High performance, with double bearing, thus ensuring high resistance to wear. Available with a rotary valve or lever valve.

Included accessories

Collet ZG 5 / 3 mm
Order no. 001 999 985
For other sizes, see page 62

Collet wrench, size 6+8
Order no. 007 899 751

Hose unit
Order no. 001 366 576



No oil-bearing compressed air required. Please operate at 6 bar.

Speed [rpm]: 50,000
Power [watts]: 150



Optional accessories

Vario-holder
Order no. 007 012 848



Connection set
Order no. 007 899 115
(without hose unit)
For details, see page 61

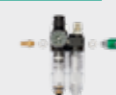

T 6-50 S
Order no. 150 149 820

Extremely long service life thanks to the larger paired bearings. Suitable especially for delicate work using rotary burrs with head diameters from 3 mm in continuous operation at 50,000 rpm. It can also be operated with rotary burrs with 6 mm head diameters.

Included accessories

Collet ZG 4 / 6 mm
Order no. 001 999 990
For other sizes, see page 62

Collet wrench, size 9+11
Order no. 007 899 874

Hose unit
Order no. 001 367 503



No oil-bearing compressed air required. Please operate at 6 bar.

Speed [rpm]: 65,000
Power [watts]: 80



Optional accessories

Vario-holder
Order no. 007 012 848



Connection set
Order no. 007 899 115
(without hose unit)
For details, see page 61



T 365/2
Order no. 150 149 730

Thanks to the elastic bearing sets, rotary burrs with a head diameter of 6 mm can be used without any vibrations. The centrifugal governor ensures a constant speed under different loads and acts as a power reserve.

Included accessories

Collet ZG 5 / 3 mm
Order no. 001 999 985
For other sizes, see page 62

Collet wrench, size 6+8
Order no. 007 899 751

Hose unit
Order no. 001 366 594



No oil-bearing compressed air required. Please operate at 6 bar.

Achieve perfect results with BIAX tungsten carbide burrs. See our catalogue of tungsten carbide tools. For further accessories, see the BIAX accessories catalogue.



Model	TVD 3-100/2 TVD 3-100/3 Ultra	TSD 385	TSH 385	T 365/2	T 3-65 S	T 6-50 S
Valve	Rotary valve	Rotary valve	Lever valve	Slide valve	Rotary valve	Rotary valve
Exhaust air direction	forwards	backwards	backwards	backwards	backwards	backwards
Front bearing set	elastic Hybrid (steel / ceramic)	pair	pair	elastic	pair	pair
Speed [rpm]	100,000	85,000	85,000	65,000	65,000	50,000
Power [watts]	80	100	100	80	80	150
Air consumption [l/min]	180	170	170	180	250	270
Noise level [dB(A)]	70	74	74	70	70	70
Weight [g]	250	190	210	220	390	400
Max. tool shaft diam. [mm]	3	3	3	3	3	6
Max. tool Ø [mm]						
Carbide tools	3	4	4	6	3	6
Mounted points	5	6	6	8	6	10

01 Straight grinders high speed & oil-free
02 High speed straight grinders
03 Straight grinders
04 Angle grinders
05 Belt sanders
06 Drilling deburrers
07 Pneumatic files
08-11 Brushing tools / chisels / pneumatic saws / drills
12 Accessories

02 High-speed grinders that require oiled compressed air for delicate deburring, grinding and engraving work (55,000–85,000 rpm)

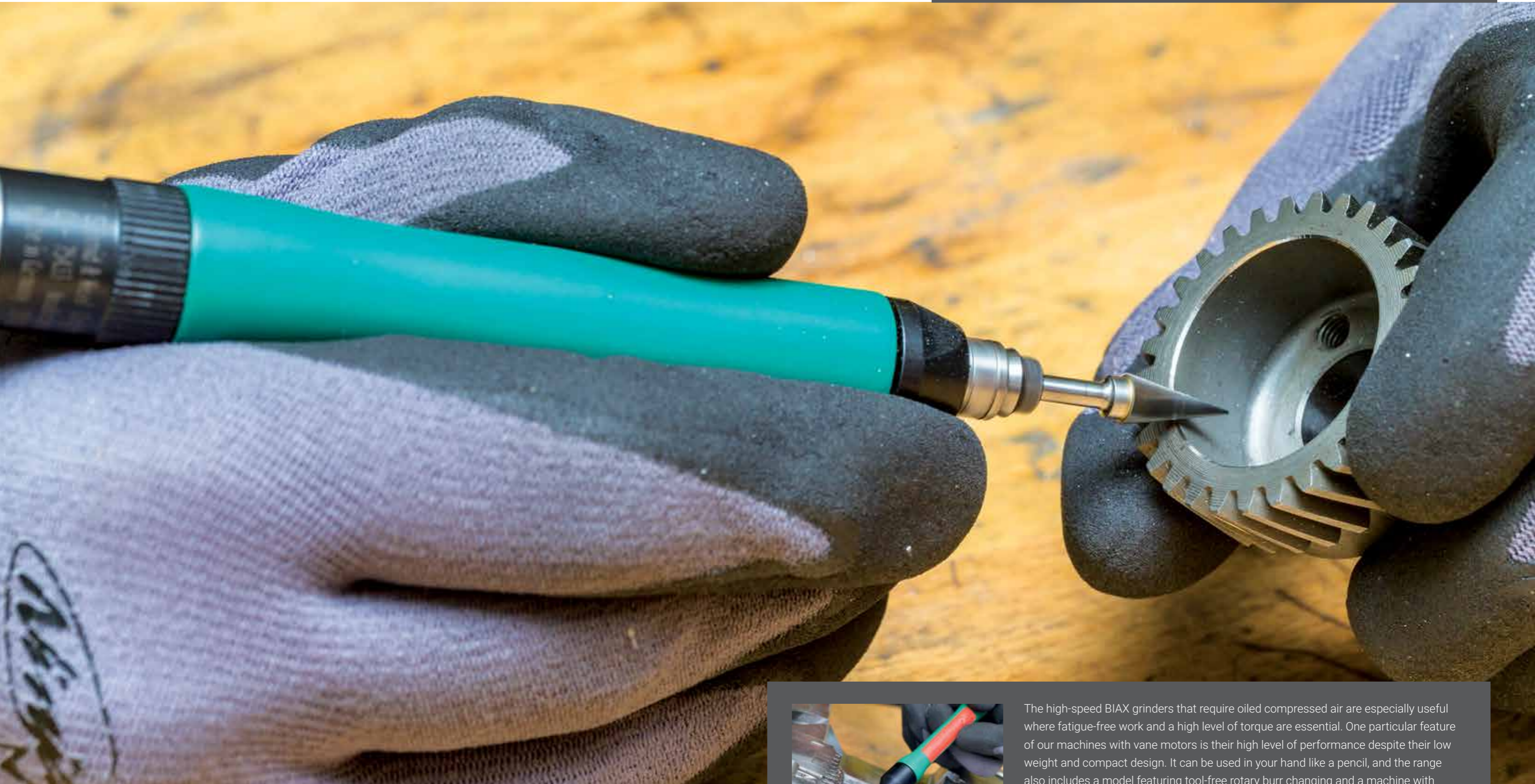

The high-speed BIAx grinders that require oiled compressed air are especially useful where fatigue-free work and a high level of torque are essential. One particular feature of our machines with vane motors is their high level of performance despite their low weight and compact design. It can be used in your hand like a pencil, and the range also includes a model featuring tool-free rotary burr changing and a machine with a special device for creating an even 45° chamfer.

Speed [rpm]: 85,000
Power [watts]: 80



SRD 3-85/2
Order no. 150 001 060
SRD 3-85/2 D HEAVY DUTY
Order no. 150 001 035

Lightweight and highly convenient machine, fits in your hand like a pencil. Surprisingly powerful, despite the speed of 85,000 rpm. Ideal for delicate grinding, milling and engraving work. The machine is available in the following models:

Bearing set: single (SRD 3-85/2) or paired (SRD 3-85/2 D) for extreme continuous operation

Exhaust air direction: backwards or forwards

Included accessories

Collet ZG 5 / 3 mm
Order no. 001 999 985
For other sizes, see page 62

Hose unit
Order no. 001 366 595

Collet wrench, size 6+8
Order no. 007 899 751



Please operate with 2-3 drops of oil per minute at 6 bar.

Optional accessories

Vario-holder
Order no. 007 012 848



Connection set
Order no. 007 899 116
(without hose unit)
For details, see page 61



SINGLE-BEARING-SET SPINDLE

The proven, robust BIAX spindle with two high-performance bearings (one at the front and one at the back) is the perfect choice for the most common applications.



DOUBLE-BEARING-SET SPINDLE

This spindle is fitted with a double bearing set at the front and is therefore even more durable and resistant to wear. Particularly suitable for tougher grinding and milling applications with high speed when a high degree of material removal is required.



Note: Achieve perfect results with BIAX carbide burrs. See our catalogue of carbide tools. For further accessories, see the BIAX accessories catalogue.

Speed [rpm]: 85,000
Power [watts]: 80



SRH 3-85/2
Order no. 150 001 065
SRH 3-85/2 D HEAVY DUTY
Order no. 150 001 040

The only difference in the SRH 3-85/2 relative to the SRD 3-85/2 described above is the lever valve. Many other models are also fitted with a lever valve.

Included accessories

Collet ZG 5 / 3 mm
Order no. 001 999 985
For other sizes, see page 62

Hose unit
Order no. 001 366 595

Collet wrench, size 6+8
Order no. 007 899 751



Please operate with 2-3 drops of oil per minute at 6 bar.

Optional accessories

Vario-holder
Order no. 007 012 848



Connection set
Order no. 007 899 116
(without hose unit)
For details, see page 61



Model	SRD 3-85/2	SRD 3-85/2D	SVD 3-85/2	SVD 3-85/2D	SRH 3-85/2	SRH 3-85/2D	SVH 3-85/2	SVH 3-85/2D
Valve	Rotary valve	Rotary valve	Rotary valve	Rotary valve	Lever valve	Lever valve	Lever valve	Lever valve
Exhaust air direction	backwards	backwards	forwards	forwards	backwards	backwards	forwards	forwards
Front bearing set	single	pair	single	pair	single	pair	single	pair
Speed [rpm]	85,000	85,000	85,000	85,000	85,000	85,000	85,000	85,000
Power [watts]	80	80	80	80	80	80	80	80
Air consumption [l/min]	170	170	170	170	170	170	170	170
Noise level [dB(A)]	76	76	78	78	76	76	78	78
Weight [g]	130	140	180	190	170	170	210	220
Max. tool shaft diam. [mm]	3	3	3	3	3	3	3	3
Max. tool Ø [mm]								
Carbide tools	4	4	4	4	4	4	4	4
Mounted points	6	6	6	6	6	6	6	6



Speed [rpm]: 55,000
Power [watts]: 60



SRD 3-55/2
Order no. 150 000 925

A class apart: small, lightweight, convenient, and with an incredibly high power-to-weight ratio (power per gram) at a speed of 55,000 rpm. The most powerful grinder of its kind. It sits in your hand like a pencil.

Included accessories

Collet ZG 5 / 3 mm
Order no. 001 999 985
For other sizes, see page 62

Hose unit
Order no. 001 366 595

Collet wrench, size 6+8
Order no. 007 899 751



Please operate with 2–3 drops of oil per minute at 6 bar.

Optional accessories

Vario-holder
Order no. 007 012 848



Connection set
Order no. 007 899 116
(without hose unit)
For details, see page 61



Speed [rpm]: 55,000
Power [watts]: 60

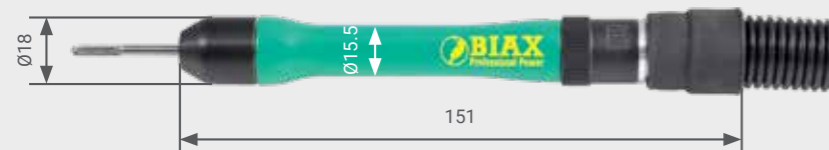

SRD 3-55/2 S
Order no. 150 000 935

Like SRD 3-55/2, but with an additional auto-lock function: tool-free clamp and release of rotary burs or grinding tools. No wear of the collets.

Included accessories

"Auto-lock" tool holder

Hose unit
Order no. 001 366 595



Please operate with 2–3 drops of oil per minute at 6 bar.



Optional accessories

Vario-holder
Order no. 007 012 848



Connection set
Order no. 007 899 116
(without hose unit)
For details, see page 61



Speed [rpm]: 55,000
Power [watts]: 60

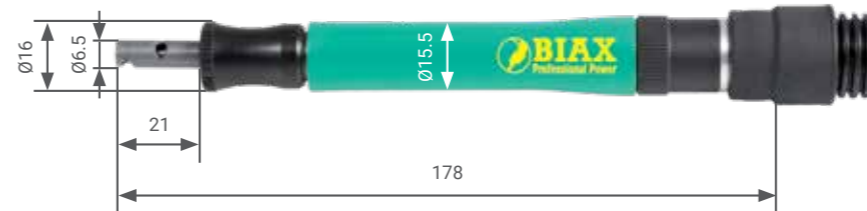

SRD 3-55/2 KE
Order no. 150 000 965

Like SRD 3-55/2, but with an additional device for breaking edges, used for creating an even 45° chamfer. Very suitable for fine burrs on straight profiles. The degree of chamfering can be adjusted. No risk of injury thanks to the protective sleeve. Can be converted easily into a normal grinder with guard by removing the attachment.

Included accessories

Collet ZG 5 / 3 mm
Order no. 001 999 985
For other sizes, see page 62

rotary burr TCA 0303-63
Order no. 001 952 011

Hose unit
Order no. 001 366 595

Collet wrench, size 6+8
Order no. 007 899 751



Please operate with 2–3 drops of oil per minute at 6 bar.

Optional accessories

Vario-holder
Order no. 007 012 848



Connection set
Order no. 007 899 116
(without hose unit)
For details, see page 61



Note: Achieve perfect results with BIAX carbide burrs. See our catalogue of carbide tools. For further accessories, see the BIAX accessories catalogue.

Model	SRD 3-55/2	SRD 3-55/2 S	SRD 3-55/2 KE
Valve	Rotary valve	Rotary valve	Rotary valve
Exhaust air direction	backwards	backwards	backwards
Front bearing set	single	single	single
Speed [rpm]	55,000	55,000	55,000
Power [watts]	60	60	60
Air consumption [l/min]	170	170	170
Noise level [dB(A)]	74	74	74
Weight [g]	93	103	95
Max. tool shaft diam. [mm]	3	3	3
Max. tool Ø [mm]			
Carbide tools	6	4	Can only be used with TCA 0303-63
Mounted points	8	8	-



03 Straight grinders (10,000–45,000 rpm)

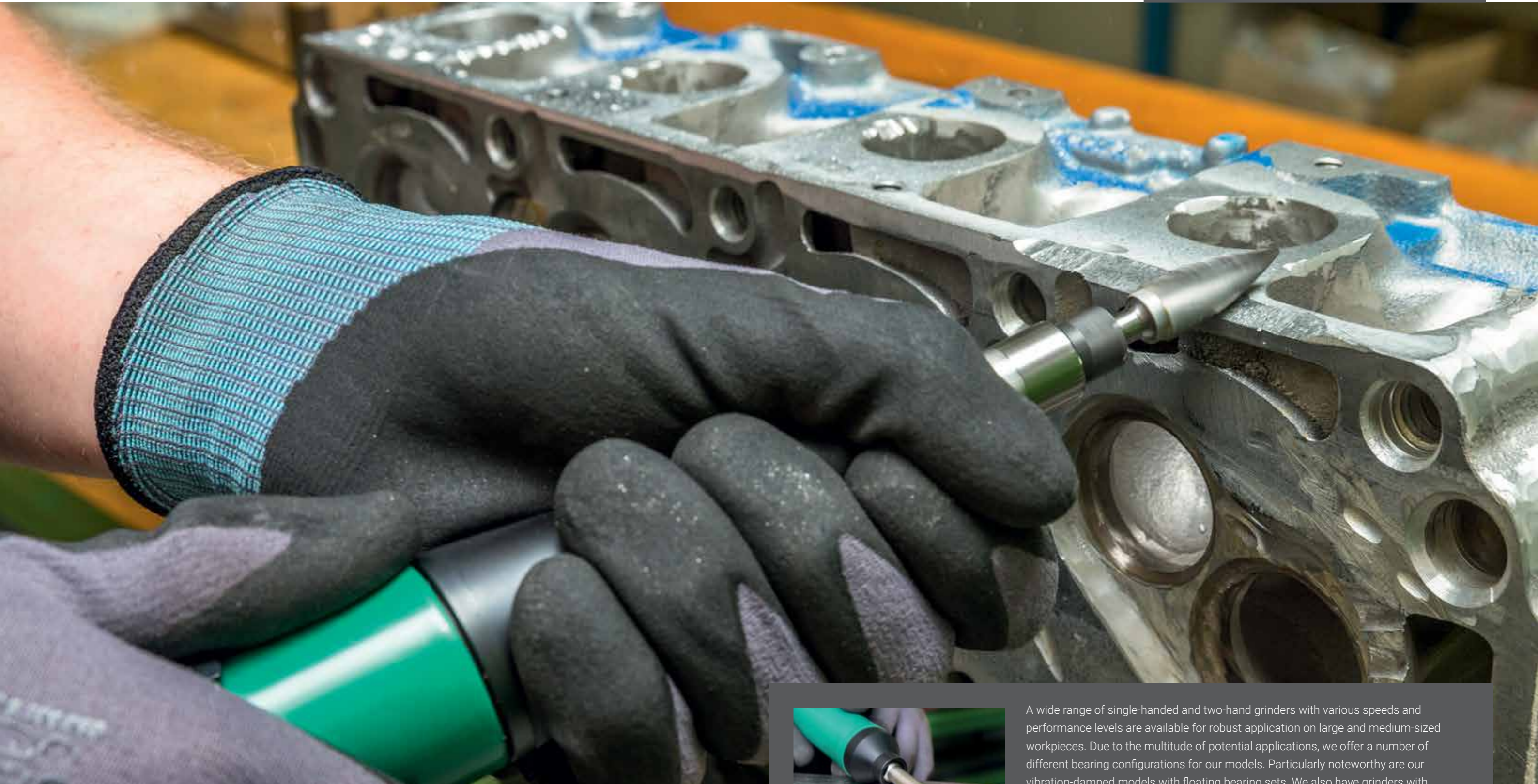

A wide range of single-handed and two-hand grinders with various speeds and performance levels are available for robust application on large and medium-sized workpieces. Due to the multitude of potential applications, we offer a number of different bearing configurations for our models. Particularly noteworthy are our vibration-damped models with floating bearing sets. We also have grinders with extending spindles for carrying out work in hard-to-reach areas. And the range is made complete with the addition of the powerful grinders for brushing.

Speed [rpm]: 45,000
Power [watts]: 260



Optional accessories

Vario-holder
Order no. 007 012 848

Connection set
Order no. 007 899 102
(incl. hose unit)
For details, see page 61

Hose unit
Order no. 001 366 577

SRD 6-45/2
Order no. 150 010 750
SRH 6-45/2
Order no. 150 010 760

A combination of high speed and outstanding performance. Can be used universally for both delicate and rough work using rotary burs with head diameters of 3–8 mm. Available with a rotary valve or lever valve.

Included accessories

Collet ZG 4 / 6 mm
Order no. 001 999 990
For other sizes, see page 62

Collet wrench,
size 9+11
Order no. 007 899 874

Please operate with 3-4 drops of oil per minute at 6 bar.

Speed [rpm]: 30,000
Power [watts]: 240/260

Please operate with 2–3 drops of oil per minute at 6 bar.

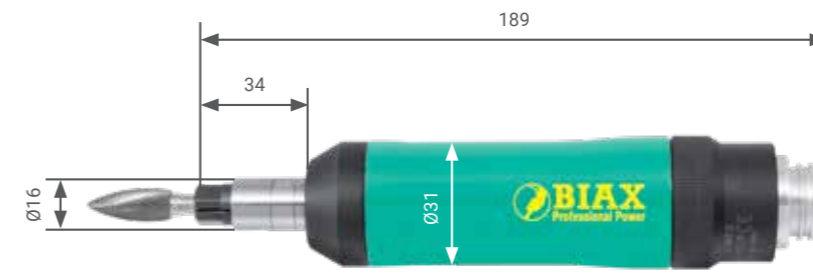

Optional accessories

Vario-holder
Order no. 007 012 848

Connection set for
SRD/SRH 8-30/2
Order no. 007 899 102
(incl. hose unit)

Connection set for
SARD/SARH 830
Order no. 007 899 101
(incl. hose unit)
For details, see page 61

Hose unit for
SRD / SRH 8-30/2
Order no. 001 366 577

Hose unit for
SARD / SARH 830
Order no. 001 366 505

SRD 8-30/2 / SRH 8-30/2
Order no. 150 010 920 / 150 010 925
SARD 830 / SARH 830 HEAVY DUTY
Order no. 150 012 005 / 150 012 015

Basic model of the grinder with 30,000 rpm. More power at lower speeds. Stronger vanes and generally higher resistance to wear. Ideal for rougher applications with rotary burs with 6–10 mm head diameters.

The SARD or SARH models are fitted with double bearing sets and are designed for rough applications. Available with a rotary valve or lever valve.

Included accessories

Collet ZG 7 / 6 mm
Order no. 001 999 981
For other sizes, see page 62

Collet wrench,
size 11+14
Order no. 007 899 747

Speed [rpm]: 45,000
Power [watts]: 260

VIBRATION-DAMPED

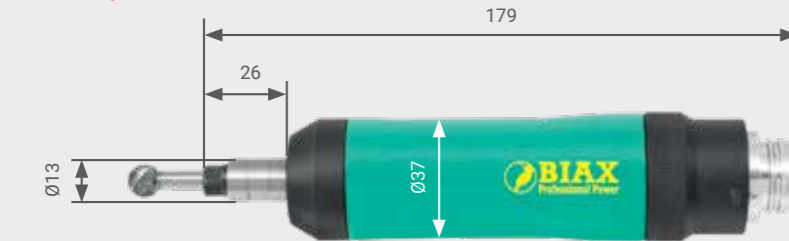

Optional accessories

Vario-holder
Order no. 007 012 848

Connection set
Order no. 007 899 102
(incl. hose unit)
For details, see page 61

Hose unit
Order no. 001 366 577

SRD 6-45/2 SL
Order no. 150 010 755
SRH 6-45/2 SL
Order no. 150 010 765

Like SRD/SRH 6-45/2, but with an floating bearing set for absorbing impacts and minimising vibrations. Prevents machining marks and creates an outstanding surface quality. Gentle on the tool and on your wrist.

Included accessories

Collet ZG 4 / 6 mm
Order no. 001 999 990
For other sizes, see page 62

Collet wrench,
size 9+11
Order no. 007 899 874

Please operate with 3-4 drops of oil per minute at 6 bar.

Speed [rpm]: 30,000
Power [watts]: 260

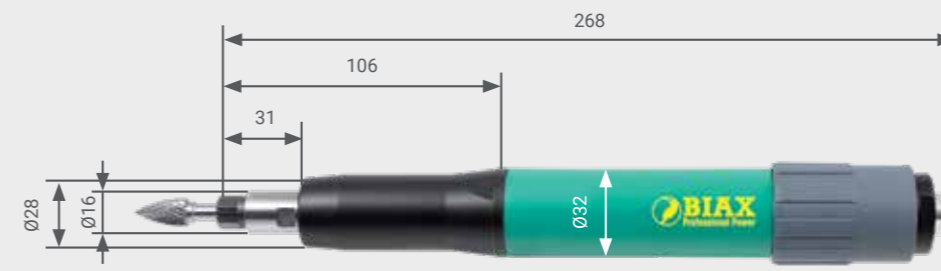

Optional accessories

Vario-holder
Order no. 007 012 848

Connection set
Order no. 007 899 101
(incl. hose unit)
For details, see page 61

Hose unit
Order no. 001 366 505

SBRD 830 HEAVY DUTY
Order no. 150 012 022
SBRH 830 HEAVY DUTY
Order no. 150 012 032

More control over large components in two-hand operation. Double bearing set for extremely rough applications. Available with a rotary valve or lever valve.

Included accessories

Collet ZG 7 / 6 mm
Order no. 001 999 981
For other sizes, see page 62

Collet wrench,
size 11+14
Order no. 007 899 747

Please operate with 2–3 drops of oil per minute at 6 bar.

Speed [rpm]: 45,000
Power [watts]: 260

Please operate with 3-4 drops of oil per minute at 6 bar.

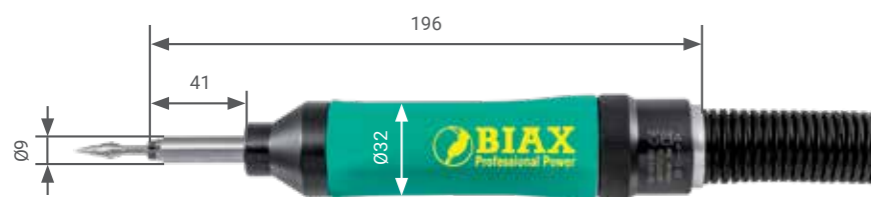

Optional accessories

Vario-holder
Order no. 007 012 848

Connection set
Order no. 007 899 102
(incl. hose unit)
For details, see page 61

Hose unit
Order no. 001 366 577

SRD 3-45/2
Order no. 150 010 770

Like SRD/SRH 6-45/2, but with a long, thin tool spindle. This allows you to place the tool flat or operate in hard-to-reach areas. Ideal for spot-grinding and reworking of moulds and tools.

Included accessories

Collet ZG 5 / 3 mm
Order no. 001 999 985
For other sizes, see page 62

Collet wrench,
size 6+8
Order no. 007 899 751

Model	SRD 6-45/2 / SRH 6-45/2	SRD 6-45/2 SL / SRH 6-45/2 SL	SRD 3-45/2	SRD 8-30/2 / SRH 8-30/2	SARD 830 / SARH 830	SBRD 830 / SBRH 830
Valve	Rotary valve / Lever valve	Rotary valve / Lever valve	Rotary valve	Rotary valve / Lever valve	Rotary valve / Lever valve	Rotary valve / Lever valve
Exhaust air direction	backwards	backwards	backwards	backwards	backwards	backwards
Front bearing set	single	floating	single	single	pair	pair
Speed [rpm]	45,000	45,000	45,000	30,000	30,000	30,000
Power [watts]	260	260	260	240	260	260
Air consumption [l/min]	380	380	380	450	400	400
Noise level [dB(A)]	76	76	76	76	75	75
Weight [g]	310 / 360	590 / 610	310	370 / 410	500 / 520	720 / 750
Max. tool shaft diam. [mm]	6	6	3	8	8	8
Max. tool Ø [mm]						
Carbide tools	8	8	6	10	10	10

Please note the information from the grinding tool manufacturer.

Special oil for all machines that require oiled compressed air. Order no. 001 365 665 1.0 l // order no. 001 365 605 5.0 l

Speed [rpm]: 30,000
Power [watts]: 280

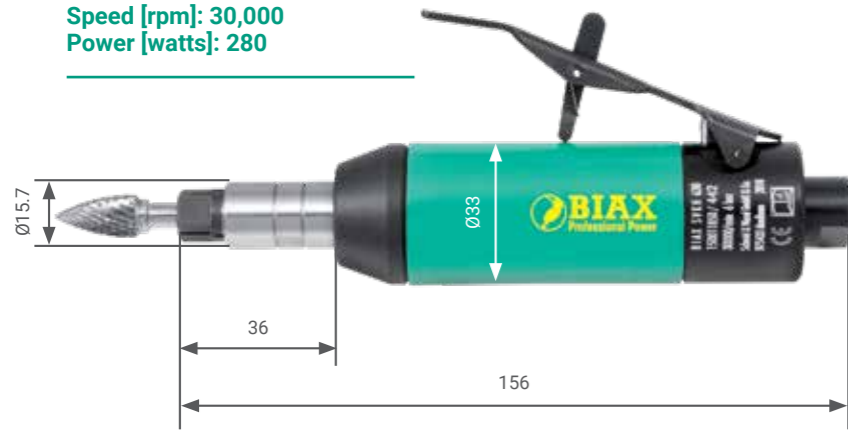

SVKH 630
Order no. 150 011 850

Very short, therefore more lightweight and convenient, and fitted with a high-torque motor. Flexible hose, exhaust air expelled forwards.

Included accessories

Collet ZG 7 / 6 mm
Order no. 001 999 981
For other sizes, see page 62

Collet wrench, size 11+14
Order no. 007 899 747

Please operate with 2-3 drops of oil per minute at 6 bar.

Optional accessories

Vario-holder
Order no. 007 012 848



Connection set
Order no. 007 899 110 (incl. hose unit)
For details, see page 61



Hose unit
Order no. 001 366 502



Speed [rpm]: 30,000
Power [watts]: 150

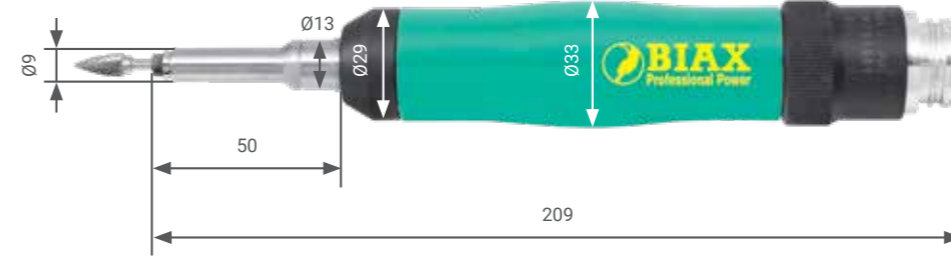

SRD 3-30/2
Order no. 150 011 522

Like SRD/SRH 6-30/2, but with a long, thin tool spindle. This allows you to place the tool flat or operate in hard-to-reach areas. Ideal for spot-grinding and reworking of moulds and tools.

Included accessories

Collet ZG 5 / 3 mm
Order no. 001 999 985
For other sizes, see page 62

Collet wrench, size 6+8
Order no. 007 899 751

Please operate with 2-3 drops of oil per minute at 6 bar.

Optional accessories

Vario-holder
Order no. 007 012 848



Connection set
Order no. 007 899 102 (incl. hose unit)
For details, see page 61



Hose unit
Order no. 001 366 577



Speed [rpm]: 30,000
Power [watts]: 240

VIBRATION-DAMPED



Please operate with 2-3 drops of oil per minute at 6 bar.

SRD 8-30/2 SL
Order no. 150 010 922
SRH 8-30/2 SL
Order no. 150 010 926

Like SRD/SRH 8-30/2, but with a floating bearing set for absorbing impacts and minimising vibrations. Prevents machining marks and creates an outstanding surface quality. Gentle on the tool and on your wrist.

Included accessories

Collet ZG 7 / 6 mm
Order no. 001 999 981
For other sizes, see page 62

Collet wrench, size 11+14
Order no. 007 899 747

Optional accessories

Vario-holder
Order no. 007 012 848



Connection set
Order no. 007 899 102 (incl. hose unit)
For details, see page 61



Hose unit
Order no. 001 366 577



THE ANTI-VIBRATION SYSTEM FROM BIAX WITH FLOATING BEARING SETS

Grinders with conventional bearings

Impacts and vibrations are not damped.



Grinders with floating bearing sets

No impacts, no vibrations, clean surface, ideal for working on weld seams.

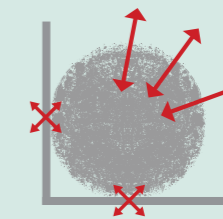

If the rotary burr is in contact with the component at multiple points simultaneously or if the rotary burr's contact surface with the component is too large, vibrations and impacts occur.

Speed [rpm]: 30,000
Power [watts]: 150

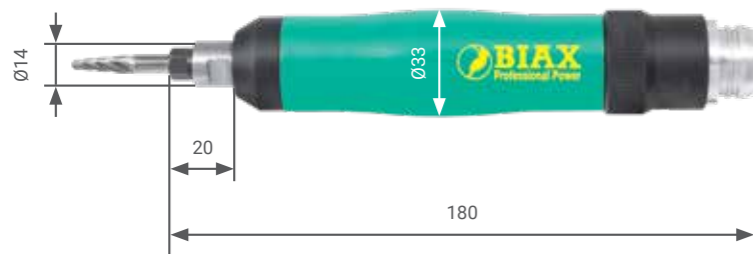

Please operate with 2-3 drops of oil per minute at 6 bar.

SRD 6-30/2
Order no. 150 011 520
SRH 6-30/2
Order no. 150 011 510

Narrower and more lightweight than SRD/SRH 8-30/2, with an ergonomic grip. Available with a rotary valve or lever valve.

Included accessories

Collet ZG 4 / 6 mm
Order no. 001 999 990
For other sizes, see page 6.

Collet wrench, size 9+11
Order no. 007 899 874

Optional accessories

Vario-holder
Order no. 007 012 848



Connection set
Order no. 007 899 102 (incl. hose unit)
For details, see page 61



Hose unit
Order no. 001 366 577

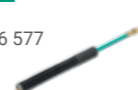

Note: Achieve perfect results with BIAX carbide burrs. See our catalogue of carbide tools. For further accessories, see the accessories catalogue.

Model	SVKH 630	SRD 8-30/2 SL / SRH 8-30/2 SL	SRD 6-30/2	SRH 6-30/2	SRD 3-30/2
Valve	Lever valve	Rotary valve / Lever valve	Rotary valve	Lever valve	Rotary valve
Exhaust air direction	forwards	backwards	backwards	backwards	backwards
Front bearing set	single	floating	double	double	double
Speed [rpm]	30,000	30,000	30,000	30,000	30,000
Power [watts]	280	240	150	150	150
Air consumption [l/min]	420	450	370	370	370
Noise level [dB(A)]	78	76	74	74	74
Weight [g]	360	500 / 540	335	390	345
Max. tool shaft diam. [mm]	8	8	6	6	3
Max. tool Ø [mm]					
Carbide tools	10	10	8	8	6

Please note the information from the grinding tool manufacturer.



Special oil for all machines that require oiled compressed air. Order no. 001 365 665 1.0 l // order no. 001 365 605 5.0 l



Speed [rpm]: 20,000
Power [watts]: 300



Optional accessories

Vario-holder
Order no. 007 012 848



Connection set
Order no. 007 899 103
(incl. hose unit)
For details, see page 61



Hose unit
Order no.
001 366 578



SRD 8-20/2
Order no. 150 020 700
SRH 8-20/2
Order no. 150 020 800

Basic model of the grinder with 20,000 rpm. Even bigger, wider and stronger for even more rugged work. Suitable for larger rotary burrs with a head diameter of up to 12 mm. Available with a rotary valve or lever valve.

Included accessories

Collet ZG 7 / 6 mm
Order no. 001 999 981
For other sizes, see page 62



Collet wrench,
size 11+14
Order no. 007 899 747



Please operate with 2–3 drops of oil per minute at 6 bar.

Speed [rpm]: 20,000
Power [watts]: 300

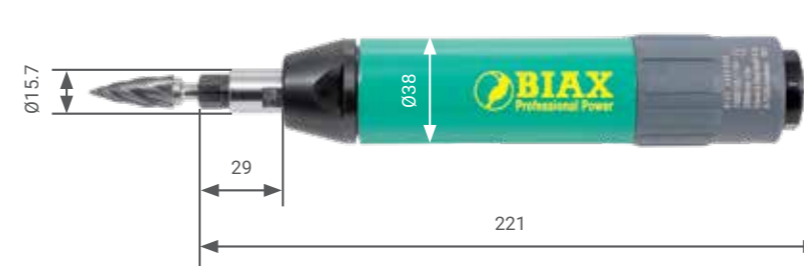

Optional accessories

Vario-holder
Order no. 007 012 848



Connection set
Order no. 007 899 101
(incl. hose unit)
For details, see page 61



Hose unit
Order no.
001 366 505



SARD 820 HEAVY DUTY
Order no. 150 021 105
SARH 820 HEAVY DUTY
Order no. 150 021 125

Single-handed machine with double bearing set for extreme applications. The centrifugal governor ensures a constant speed under different loads and acts as a power reserve. Available with a rotary valve or lever valve.

Included accessories

Collet ZG 7 / 6 mm
Order no. 001 999 981
For other sizes, see page 62



Collet wrench,
size 11+14
Order no. 007 899 747



Please operate with 2–3 drops of oil per minute at 6 bar.

Speed [rpm]: 20,000
Power [watts]: 300

VIBRATION-DAMPED



Optional accessories

Vario-holder
Order no. 007 012 848



Connection set
Order no. 007 899 103
(incl. hose unit)
For details, see page 61



Hose unit
Order no.
001 366 578



SRD 8-20/2 SL
Order no. 150 020 705
SRH 8-20/2 SL
Order no. 150 020 805

Like SRD/SRH 8-20/2, but with a floating bearing set for absorbing impacts and minimising vibrations. Prevents machining marks and creates an outstanding surface quality. Gentle on the tool and on your wrist.

Included accessories

Collet ZG 7 / 6 mm
Order no. 001 999 981
For other sizes, see page 62



Collet wrench,
size 11+14
Order no. 007 899 747



Please operate with 2–3 drops of oil per minute at 6 bar.

Speed [rpm]: 20,000
Power [watts]: 300

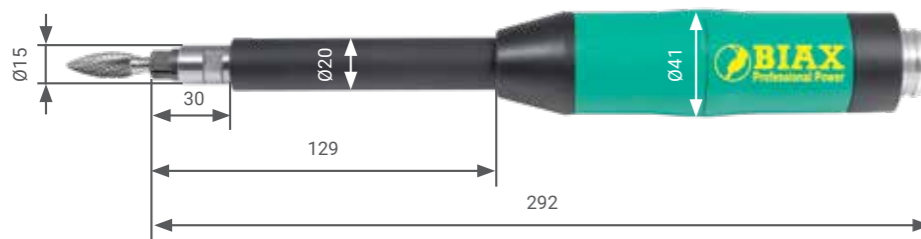

Optional accessories

Connection set
Order no. 007 899 103
(incl. hose unit)
For details, see page 61



Hose unit
Order no.
001 366 578

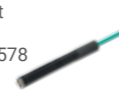

SRD 8-20/2 L 100 / or L 200
Order no. 150 020 710 /
or 150 020 720
SRH 8-20/2 L 100 / or L 200
Order no. 150 020 810 /
or 150 020 820

Like SRD/SRH 8-20/2, but extended by 100 cm or 200 cm. Suitable for work on hard-to-reach areas.

Included accessories

Collet ZG 7 / 6 mm
Order no. 001 999 981
For other sizes, see page 62



Collet wrench,
size 11+14
Order no. 007 899 747



Please operate with 2–3 drops of oil per minute at 6 bar.



CARBIDE TOOLS
Reduce costs with the right combination of rotary burr and grinder

TCB 1206-63



TCC 0806-63



TCD 1206-63



TCF 1206-63



TCG 1216-03



Smoothing off weld seams? Working with extremely greasy aluminium? Or particularly rough applications with an extremely high level of material removal? The key to achieving the perfect results is choosing the right combination of rotary burr and pneumatic tool. But in order to determine the optimum results, carrying out a practical test is an essential step. We can give you the help and advice you need.

Model	SRD 8-20/2 / SRH 8-20/2	SRD 8-20/2 SL / SRH 8-20/2 SL	SRD 8-20/2 L100 / SRH 8-20/2 L100	SRD 8-20/2 L200 / SRH 8-20/2 L200	SARD 820 / SARH 820
Valve	Rotary valve / lever valve	Rotary valve / lever valve	Rotary valve / lever valve	Rotary valve / lever valve	Rotary valve / lever valve
Exhaust air direction	backwards	backwards	backwards	backwards	backwards
Front bearing set	single	floating	elastic	elastic	double
Speed [rpm]	20,000	20,000	20,000	20,000	20,000
Power [watts]	300	300	300	300	300
Air consumption [l/min]	500	500	500	500	500
Noise level [dB(A)]	74	74	74	74	73
Weight [g]	570 / 620	630 / 680	750 / 790	940 / 980	770 / 830
Max. tool shaft diam. [mm]	8	8	8	8	8
Max. tool Ø [mm]					
Carbide tools	12	12	12	12	12

Please note the information from the grinding tool manufacturer.



Speed [rpm]: 20,000
Power [watts]: 300

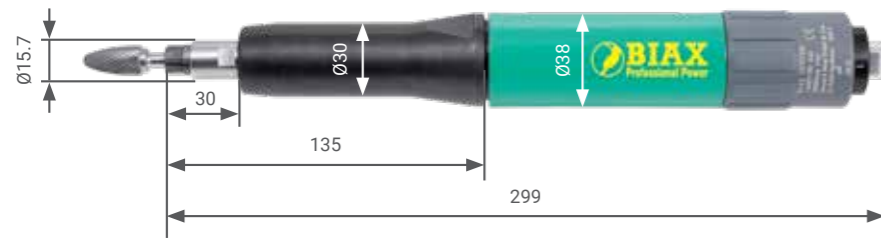

Optional accessories

Connection set
Order no. 007 899 101
(incl. hose unit)
For details, see page 61

Hose unit
Order no.
001 366 505

SBRD 820 HEAVY DUTY
Order no. 150 021 135
SBRH 820 HEAVY DUTY
Order no. 150 021 115

More control over large components in two-hand operation. The double bearing set makes it suitable for extreme applications. Available with a rotary valve or lever valve.

Included accessories

Collet ZG 7 / 6 mm
Order no. 001 999 981
For other sizes, see page 62

Collet wrench,
size 11+14
Order no. 007 899 747

Please operate with 2-3 drops of oil per minute at 6 bar.

Speed [rpm]: 12,000
Power [watts]: 400

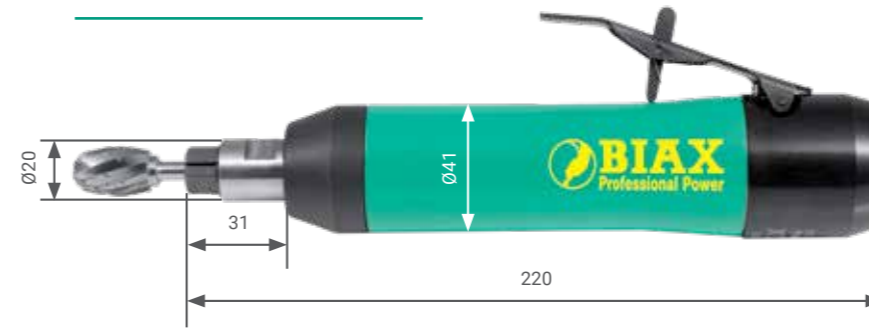

Optional accessories

Vario-holder
Order no. 007 012 848

Connection set
Order no. 007 899 109
(incl. hose unit)
For details, see page 61

Hose unit
Order no.
001 366 580

SRH 10-12/2
Order no. 150 010 950

High performance at lower speeds. SRH 10-12 is ideal for the use of brushes.

Included accessories

Collet ZG 8 / 6 mm
Order no. 001 999 977
For other sizes, see page 62

Collet wrench,
size 14+17
Order no. 007 899 721

Please operate with 2-3 drops of oil per minute at 6 bar.

Speed [rpm]: 18,000
Power [watts]: 550

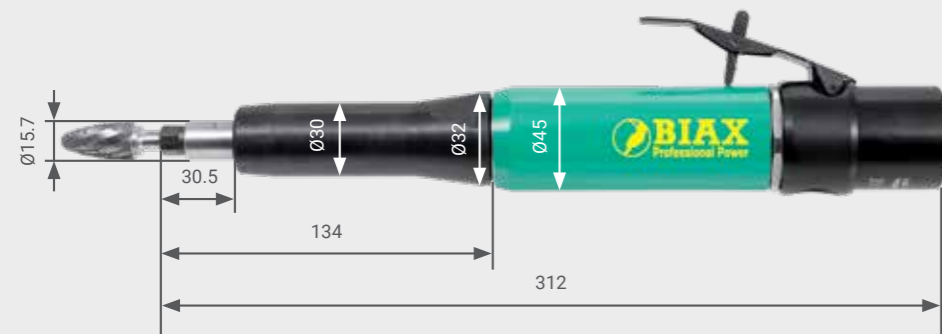

Optional accessories

Connection set
Order no. 007 899 105
(incl. hose unit)
For details, see page 61

Hose unit
Order no.
001 366 528

SBRH 818 HEAVY DUTY
Order no. 150 021 210

Most powerful, high-torque BIAX two-handed grinder with double bearing set for the toughest applications.

Included accessories

Collet ZG 7 / 6 mm
Order no. 001 999 981
For other sizes, see page 62

Collet wrench,
size 11+14
Order no. 007 899 747

Please operate with 2-3 drops of oil per minute at 6 bar.

Speed [rpm]: 10,000
Power [watts]: 280



Optional accessories

Vario-holder
Order no. 007 012 848

Connection set
Order no. 007 899 101
(incl. hose unit)
For details, see page 61

Hose unit
Order no.
001 366 505

SRH 8-10
Order no. 150 010 980

Smaller and lighter, with a slightly reduced speed. Ideal for lighter work using brushes and fan grinders, as well as for polishing.

Included accessories

Collet ZG 7 / 6 mm
Order no. 001 999 981
For other sizes, see page 62

Collet wrench,
size 11+14
Order no. 007 899 747

Please operate with 2-3 drops of oil per minute at 6 bar.

Speed [rpm]: 12,000
Power [watts]: 400 / 300

Please operate with 2-3 drops of oil per minute at 6 bar.

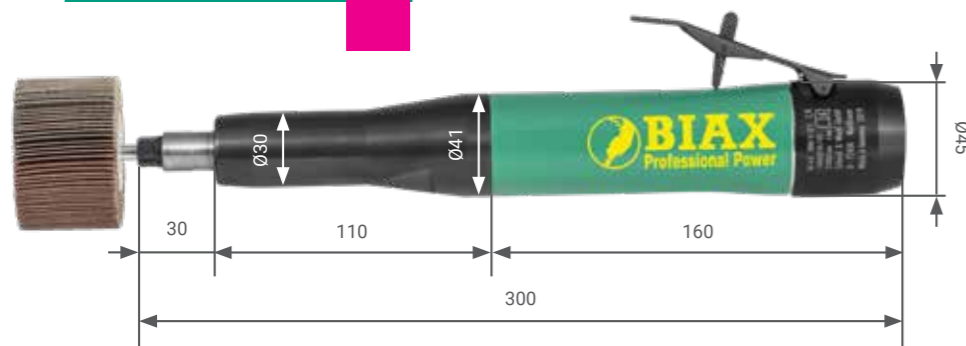

Optional accessories

Connection set
Order no. 007 899 103 (SBRD 8-12/2)
Order no. 007 899 109 (SBRH 8-12/2)
(incl. hose unit)
For details, see page 61

Hose unit
Order no. 001 366 578 (SBRD 8-12/2)
Order no. 001 366 580 (SBRH 8-12/2)

SBRD 8-12/2 (rotary valve) HEAVY DUTY
Order no. 150 020 750
SBRH 8-12/2 (lever valve) HEAVY DUTY
Order no. 150 020 770

Speed and performance are ideal for realizing high material removal when brushing, grinding and milling when working with large tools. Due to the elongated shape and particularly stable storage, this machine can be optimally guided and achieve an excellent result. Thanks to the centrifugal governor, the SBRD 8-12 / 2 has extremely low air consumption, which even runs to around 120 l / min when idling, sinks.

Included accessories

Collet ZG 7 / 6 mm
Order no. 001 999 981
For other sizes, see page 62

Collet wrench,
size 11+14
Order no. 007 899 747

Model	SBRD 820 / SBRH 820	SBRH 818	SBRD 8-12/2 / SBRH 8-12/2	SRH 10-12/2	SRH 8-10
Valve	Rotary valve / lever valve	Lever valve	Rotary valve / lever valve	Lever valve	Lever valve
Exhaust air direction	backwards	backwards	backwards	backwards	backwards
Front bearing set	double	double	double	single	double
Speed [rpm]	20.000	18.000	12.000	12.000	10.000
Power [watts]	300	550	300 / 400	400	280
Air consumption [l/min]	500	750	320 / 850	700	300
Noise level [dB(A)]	73	79	65 / 77	79	67
Weight [g]	1040 / 1100	1440	1040 / 1268	960	645
Max. tool shaft diam. [mm]	8	8	8	10	8
Max. tool Ø [mm]					
Carbide tools	12	15	15	15	16

Please note the information from the grinding tool manufacturer.

Special oil for all machines that require oiled compressed air. Order no. 001 365 665 1.0 l // order no. 001 365 605 5.0 l

04 Angle grinders

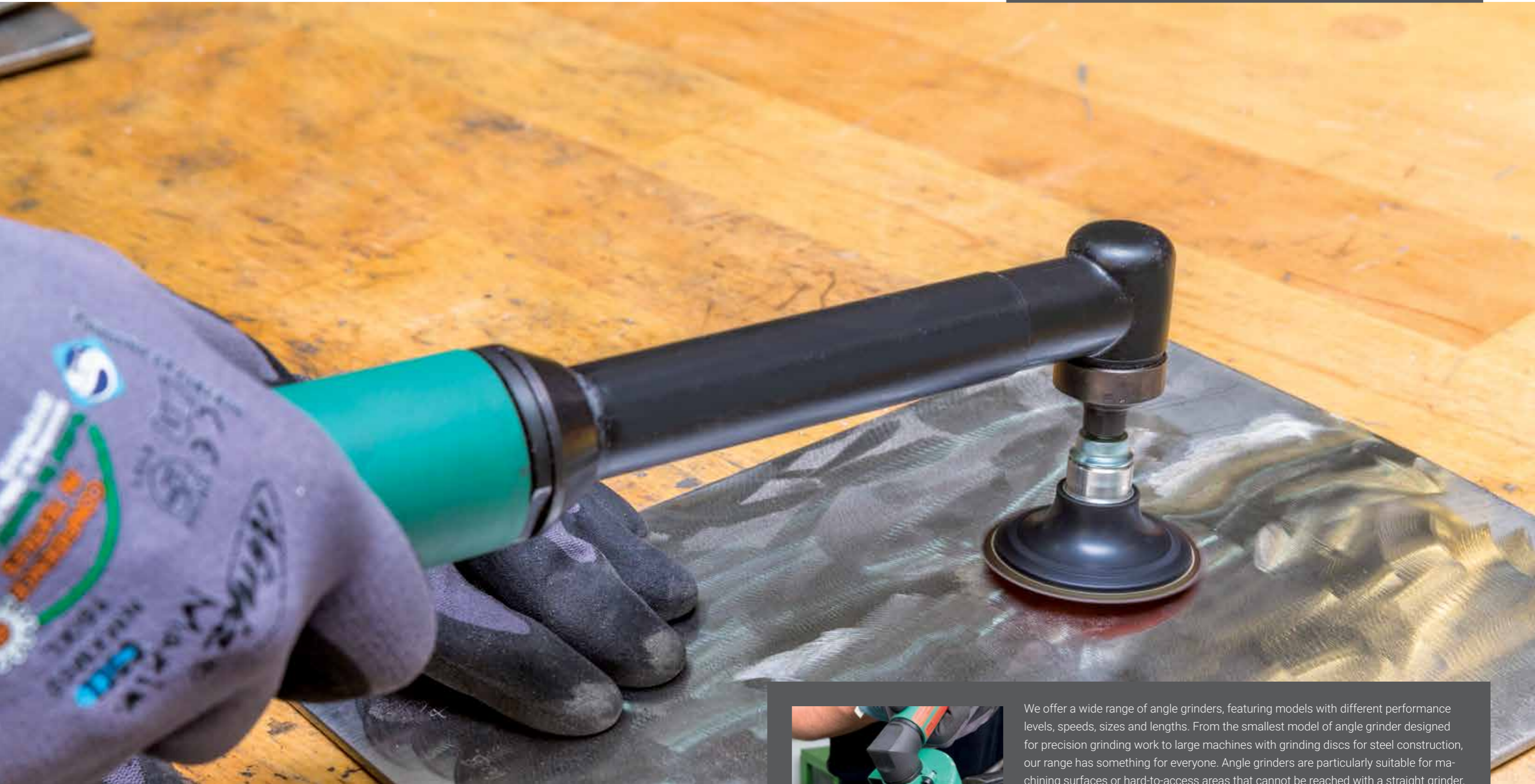

We offer a wide range of angle grinders, featuring models with different performance levels, speeds, sizes and lengths. From the smallest model of angle grinder designed for precision grinding work to large machines with grinding discs for steel construction, our range has something for everyone. Angle grinders are particularly suitable for machining surfaces or hard-to-access areas that cannot be reached with a straight grinder.

Speed [rpm]: 85,000
Power [watts]: 100



Optional accessories

Connection set
Order no. 007 899 116
(incl. hose unit)
For details, see page 61



WRD 3-85/2
Order no. 150 100 315
WRH 3-85/2
Order no. 150 100 305

Small, lightweight and convenient. The drive is integrated in the angled head, with no gear unit, making the tool more stable and resistant to wear. Perfect for carrying out work on hard-to-reach areas. Available with a rotary or lever valve.

Included accessories

Collet ZG 5 / 3 mm
Order no. 001 999 985
For other sizes, see page 62

Collet wrench,
size 6+8
Order no. 007 899 751

Hose unit
Order no. 001 366 595



Please operate with 2–3 drops of oil per minute at 6 bar.

Speed [rpm]: 20,000
Power [watts]: 300



Optional accessories

Connection set
Order no. 007 899 103
(incl. hose unit)
For details, see page 61



Hose unit
Order no.
001 366 578



Cutting disc 7.6x2.0x10
Order no. 001 451 713

WRD 10-20/3S
Order no. 150 123 455
WRH 10-20/3S
Order no. 150 123 465

Like WRD/WRH 6-20/3Z, but with an M10 fitting. Perfect for rough plastering and cutting work.

Included accessories

Single open-end spanner, 17 mm

Schruppscheibe A24/30P
Order no. 001 451 606

Please operate with 2–3 drops of oil per minute at 6 bar.

Speed [rpm]: 20,000
Power [watts]: 300



Optional accessories

Connection set
Order no. 007 899 103
(incl. hose unit)
For details, see page 61



Hose unit
Order no.
001 366 578



WRD 6-20/3Z
Order no. 150 123 475
WRH 6-20/3Z
Order no. 150 123 485

Powerful and durable. With a double bearing set and a robust gear unit in the angled head. Numerous tools can be used thanks to the collet system. Available with a rotary valve or lever valve.

Included accessories

Collet ZG 4 / 6 mm
Order no. 001 999 990
For other sizes, see page 62

Collet wrench,
size 9+11
Order no. 007 899 874



Please operate with 2–3 drops of oil per minute at 6 bar.



Note: Achieve perfect results with our grinding discs. See the BIAX accessories catalogue.



Model	WRD 3-85/2	WRH 3-85/2	WRD 6-20/3Z	WRH 6-20/3Z	WRD 10-20/3S	WRH 10-20/3S
Valve	Rotary valve	Lever valve	Rotary valve	Lever valve	Rotary valve	Lever valve
Exhaust air direction	backwards	backwards	backwards	backwards	backwards	backwards
Front bearing set	pair	pair	pair	pair	pair	pair
Speed [rpm]	85,000	85,000	20,000	20,000	20,000	20,000
Power [watts]	100	100	300	300	300	300
Air consumption [l/min]	170	170	500	500	500	500
Noise level [dB(A)]	74	74	78	78	78	78
Weight [g]	260	230	730	770	880	920
Max. tool shaft diam. [mm]	3	3	6	6	M10	M10
Max. tool Ø [mm]						
Carbide tools	4	4	12	12	-	-
Mounted points	6					

Please note the information from the grinding tool manufacturer.



Special oil for all machines that require oiled compressed air. Order no. 001 365 665 1.0 | // order no. 001 365 605 5.0 |



Speed [rpm]: 20,000
Power [watts]: 300

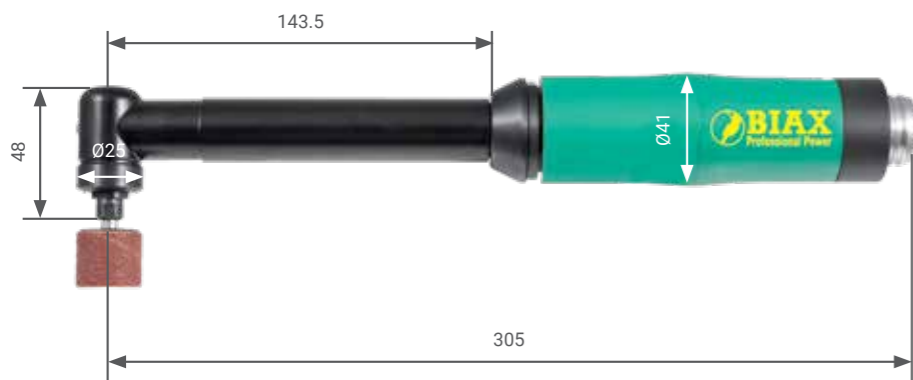

WRD 6-20/2 ZL 90
Order no. 150 123 430
WRH 6-20/2 ZL 90
Order no. 150 123 440

Small 90° angled head with extended neck. Suitable for work on hard-to-reach areas. Numerous tools can be used thanks to the collet system. Available with a rotary or lever valve.

Included accessories

Collet ZG 4 / 6 mm
Order no. 001 999 990
For other sizes, see page 62

Collet wrench,
size 9+11
Order no. 007 899 874

Please operate with 2–3 drops of oil per minute at 6 bar.

Optional accessories

Connection set
Order no. 007 899 103
(incl. hose unit)
For details, see page 61



Hose unit
Order no.
001 366 578



Speed [rpm]: 20,000
Power [watts]: 300



WRD 6-20/2 ZL 45
Order no. 150 123 490
WRH 6-20/2 ZL 45
Order no. 150 123 500

Like WRD/WRH 6-20/2 ZL 90, but with a 45° angled head.

Included accessories

Collet ZG 4 / 6 mm
Order no. 001 999 990
For other sizes, see page 62

Collet wrench,
size 9+11
Order no. 007 899 874

Please operate with 2–3 drops of oil per minute at 6 bar.

Optional accessories

Connection set
Order no. 007 899 103
(incl. hose unit)
For details, see page 61



Hose unit
Order no.
001 366 578



Speed [rpm]: 13,000
Power [watts]: 600



WRH 14-13/2
Order no. 150 912 010

The most powerful BIAX angle grinder. The drive is integrated in the angled head, with no gear unit, making the tool more stable and resistant to wear. Perfect for rough machining and for rough work in steel structures.

Included accessories

Assembly spanner
Hand grip

Grinding wheel
Order no. 001 451 603

Please operate with 2–3 drops of oil per minute at 6 bar.

Optional accessories

Connection set
Order no. 007 899 109
(incl. hose unit)
For details, see page 61



Hose unit
Order no. 001 366 580

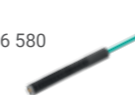

Note: Achieve perfect results with our grinding discs. See the BIAX accessories catalogue.



Model	WRD 6-20/2 ZL 90	WRH 6-20/2 ZL 90	WRD 6-20/2 ZL 45	WRH 6-20/2 ZL 45	WRH 14-13/2
Valve	Rotary valve	Lever valve	Rotary valve	Lever valve	Lever valve
Exhaust air direction	backwards	backwards	backwards	backwards	backwards
Front bearing set	single	single	single	single	single
Speed [rpm]	20,000	20,000	20,000	20,000	13,000
Power [watts]	300	300	300	300	600
Air consumption [l/min]	500	500	500	500	700
Noise level [dB(A)]	78	78	78	78	80
Weight [g]	930	960	940	980	1760
Max. tool shaft diam. [mm]	6	6	6	6	M14
Max. tool Ø [mm]					
Carbide tools	10	10	10	10	-

Please note the information from the grinding tool manufacturer.



05 Belt sanders



Our belt sanders are highly robust and durable. Especially the guide rollers under the highest loads are of uncompromisingly high quality. All models feature a very good belt guiding mechanism, and there are grinding arms and suitable high-quality sanding belts for all common applications. Belt sanders are generally used for finer and flatter applications, since they offer more control over material removal and the results are more consistent. Furthermore, they can be used for direct machining of surfaces.

Speed [rpm]: 20,000
Power [watts]: 300

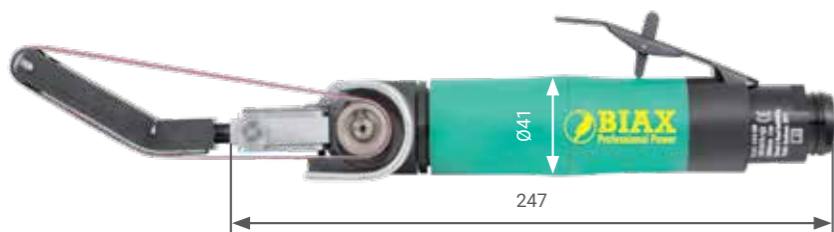

HBH 200
Order no. 150 123 770

Highly convenient, tool-free arm and belt changing, easy belt running adjustment. The grinding arms can be swivelled by 360°. For belt widths of 8, 15 and 20 mm.

Included accessories

Assembly spanner

Please operate with 2–3 drops of oil per minute at 6 bar.

Optional accessories

Connection set
Order no. 007 899 103
(incl. hose unit)
For details, see page 61

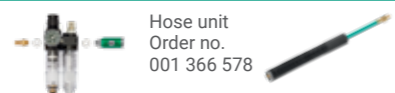

Grinding arms for HBH 200				Sanding belts		
Roller Ø	14.0 mm	14.0 mm	14.0 mm	Length x width	Grit size	Order no.
Width	4.5 mm	11.5 mm	15.5 mm			
	S 8 B	S 15 B	S 20 B	330 x 8	60	001 620 509
with straight rubber roller	150 124 875	150 124 880	150 124 885	for	120	001 620 511
Slide lining	003 010 332	003 010 333	003 009 523	S 8 A	180	001 620 512
				S 8 B	240	001 620 513
	S 8 A	S 15 A	S 20 A	330 x 15	60	001 620 508
with straight steel roller	150 124 850	150 124 855	150 124 860	for	80	001 620 515
Slide lining	003 010 332	003 010 333	003 009 523	S 15 A	120	001 620 516
				S 15 B	180	001 620 517
				S 15 C	240	001 620 518
	-	S 15 C	S 20 C	330 x 20	60	001 620 584
angled, with steel roller	-	150 124 865	150 124 870	for	120	001 620 586
Slide lining		003 010 333	003 009 523	S 20 A	180	On request
				S 20 B S 20 C	240	On request



Speed [rpm]: 20,000
Power [watts]: 300

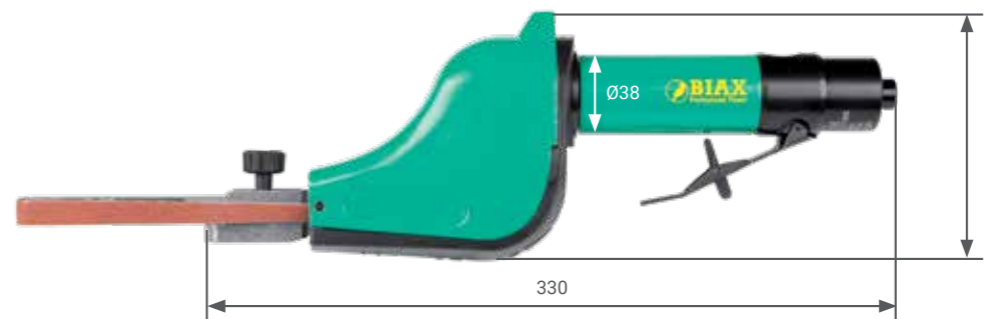

HB 12 S
Order no. 150 123 105

Very good belt guiding mechanism thanks to the high tension. This improves control and makes it suitable for use in tough conditions. The hand grip can be rotated 360°. For belt widths from 6 and 12 mm.

Included accessories

Assembly spanner

Please operate with 2–3 drops of oil per minute at 6 bar.

Optional accessories

Connection set
Order no. 007 899 103
(incl. hose unit)
For details, see page 61

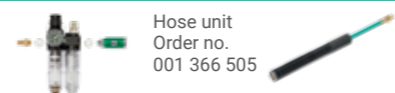

Grinding arms for HB 12 S					Sanding belts		
Roller	Rollers Ø / width	Belt width	Model	Order no.	Length x width	Grit size	Order no.
Rubber	16mm/3mm	6	HB 6163	150 123 320	610 x 6	60	001 620 559
Slide lining, medium hardness				001 610 413	610 x 6	120	001 620 561
Slide lining, soft				001 610 412	610 x 6	180	001 620 562
					610 x 6	240	001 620 570
Rubber	25mm/9mm	6	HB 6259	150 123 330	610 x 6	60	001 620 559
				-	610 x 6	120	001 620 561
				-	610 x 6	180	001 620 562
					610 x 6	240	001 620 570
Steel	8mm/9mm	12	HB 1289	150 123 310	610 x 12	60	001 620 565
Slide lining, medium hardness				001 610 414	610 x 12	120	001 620 567
					610 x 12	180	001 620 568
					610 x 12	240	001 620 571
Rubber	16mm/9mm	12	HB 12169	150 123 300	610 x 12	60	001 620 565
Slide lining, medium hardness				001 610 413	610 x 12	120	001 620 567
Slide lining, soft				001 610 412	610 x 12	180	001 620 568
					610 x 12	240	001 620 571
Rubber	18mm/12mm	12	HB 121812	150 123 340	610 x 12	60	001 620 565
Slide lining, medium hardness				001 610 413	610 x 12	120	001 620 567
Slide lining, soft				001 610 412	610 x 12	180	001 620 568
					610 x 12	240	001 620 571



Speed [rpm]: 20,000
Power [watts]: 300

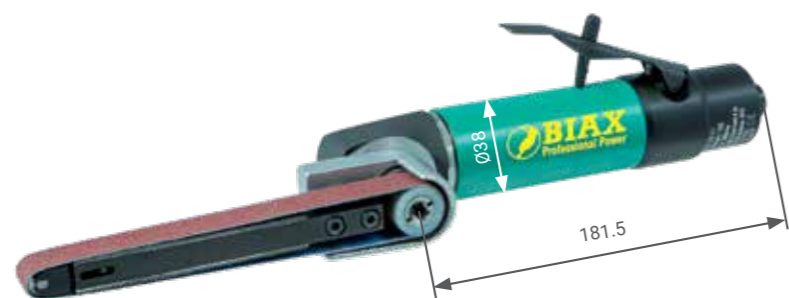

HB 15-1 Order no. 150 123 645

Compact belt sander for belt widths from 8 and 15 mm. Long grinding arm available for 475 mm sanding belts.

Included accessories

Assembly spanner
Sanding belt 330 x 15 (grit size 120)
Sanding belt 330 x 8 (grit size 120)

Please operate with 2–3 drops of oil per minute at 6 bar.

Optional accessories

Connection set
Order no. 007 899 101
(incl. hose unit)
For details, see page 61



Hose unit
Order no.
001 366 505



	Grinding arms for HBH 15-1				Sanding belts		
	Roller Ø / width	Belt width	Designation	Order no.	Length x width	Grit size	Order no.
	11 mm / 5 mm	8	8 A-1	150 122 020	330 x 8	60	001 620 509
Slide lining					330 x 8	120	001 620 511
					330 x 8	180	001 620 512
					330 x 8	240	001 620 513
	11 mm / 12 mm	15	15 A-1	150 122 120	330 x 15	60	001 620 508
Slide lining					330 x 15	120	001 620 516
					330 x 15	180	001 620 517
					330 x 15	240	001 620 518
	11 mm / 12 mm	15	15 C-1	150 122 320	330 x 15	60	001 620 508
Slide lining					330 x 15	120	001 620 516
					330 x 15	180	001 620 517
					330 x 15	240	001 620 518
	11 mm / 12 mm	15	15 AL-1	150 122 520	475 x 15	60	001 620 572
Slide lining					475 x 15	120	001 620 573
					475 x 15	180	001 620 574
					475 x 15	240	001 620 575

Speed [rpm]: 20,000
Power [watts]: 300

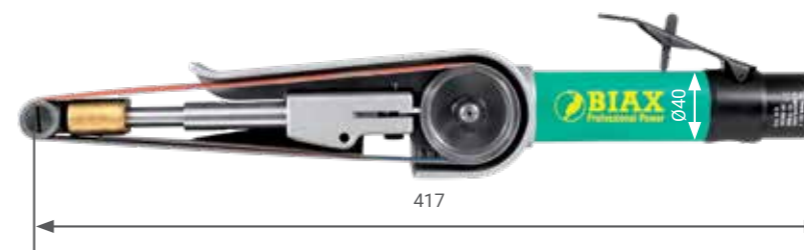

HB 20 Order no. 150 122 602

The largest belt sander in the BIA X range, with an extra-long and robust arm (190 mm) for large components. Very smooth operation thanks to the good tensioning. The grinding arm can be swivelled by 360°.

Included accessories

Grinding arm
Order no. 088 002 087

Sanding belt 520 x 20 (grit size 120)
Order no. 001 620 540

Please operate with 2–3 drops of oil per minute at 6 bar.

Optional accessories

Connection set
Order no. 007 899 101
(incl. hose unit)
For details, see page 61



Hose unit
Order no.
001 366 505



Sanding belts 20 x 520:
Grit size 60 order no. 001 620 539
Grit size 180 order no. 001 620 541
Grit size 240 order no. 001 620 542



Model	HBH 200	HB 12 S	HB 15-1	HB 20
Valve	Lever valve	Lever valve	Lever valve	Lever valve
Exhaust air direction	backwards	backwards	backwards	backwards
Belt speed [m/s]	25	30	20	50
Power [watts]	300	300	300	300
Air consumption [l/min]	500	500	420	500
Noise level [dB(A)]	78	78	78	81
Weight [g]	870	1470	960	1520
Max. belt width [mm]	20	12	15	20

Grinding arm only include in scope of delivery in the case of HB 20



06 Drilling deburrers



For the deburring of drilled holes, BIAx offers a wide range of special machines with angled or straight designs in various sizes and performance levels. The angled drilling deburrers are ideal for deburring internal cross holes. All straight drilling deburrers are equipped with a push start feature and a hook so they can be hung up. Compared to battery-powered tools, the pneumatic units are more lightweight and ergonomic, and are more efficient thanks to the push-start feature. Even compared to a machining centre or a box column drilling machine, our hand-operated tools are more economical.

Speed [rpm]: 0–900
Power [watts]: 20

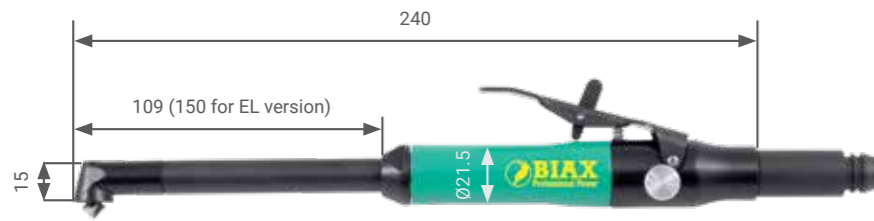

Optional accessories

HSS countersink Ø 12 mm, for countersinking range / hole Ø 2.5–10 mm / order no. 001 950 297

Carbide countersink Ø 8 mm for countersinking range / hole Ø 2–6 mm / order no. 001 950 299

Special drill Ø 2 mm
Order no. 007 014 142

Connection set
Order no. 007 899 116
(without hose unit)
For details, see page 61

Special burr, round shape, head-Ø 6 mm
Order no. 001 952 921

BEW 309 E
Order no. 150 800 726
BEW 309 EL 150
on request

Angled drilling deburrer with an extremely small head height of 15 mm (without countersink) thanks to the unique tool holder without collet. It is a lightweight and powerful machine with adjustable speed. Suitable for countersinks, drills and carbide burs with special mounts. It is ideal for deburring internal cross holes in extremely hard-to-reach areas.

Included accessories

HSS countersink Ø 8 mm for countersinking range / hole Ø 2–6 mm
Order no. 001 950 293

Hose unit
Order no. 001 366 549

Please operate with 2–3 drops of oil per minute at 6 bar.

Speed [rpm]: 0–500
Power [watts]: 80

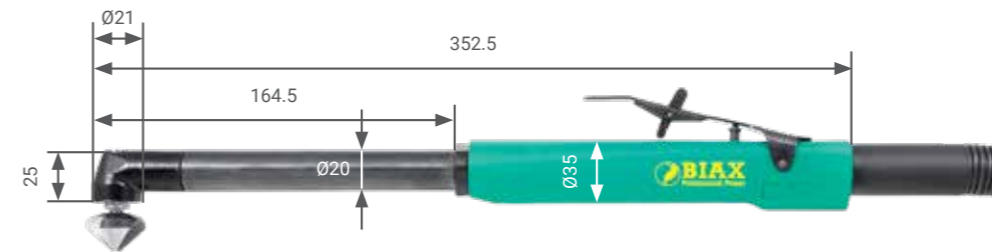

Optional accessories

HSS countersink Ø 15 mm, for countersinking range / hole Ø 3.5–14 mm
Order no. 001 950 295

HSS countersink Ø 25.5 mm, for countersinking range / Hole Ø 5–24 mm
Order no. 001 950 296

Connection set
Order no. 007 899 116
(without hose unit)
For details, see page 61

BEW 605
Order no. 150 810 930

Larger head with collet, as well as a larger and more stable gear unit. Speed is adjustable. Particularly suitable for deburring larger holes.

Included accessories

Collet, 6 mm

Collet wrench

Hose unit
Order no. 001 366 548

Please operate with 2–3 drops of oil per minute at 6 bar.

Speed [rpm]: 0–600
Power [watts]: 80

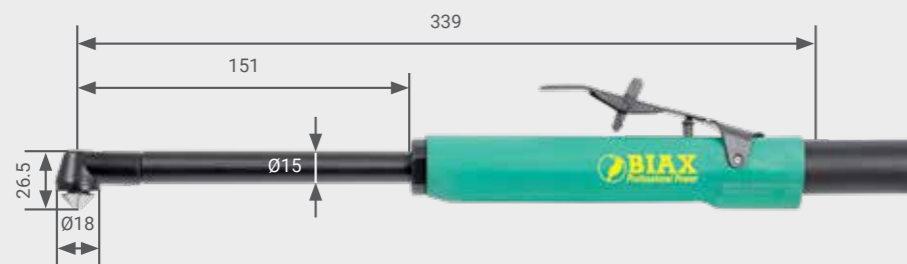

Optional accessories

Connection set
Order no. 007 899 116
(without hose unit)
For details, see page 61

BEW 606
Order no. 150 810 925

Angled drilling deburrer with a very small head diameter of 18 mm (without countersink) thanks to the unique tool holder without collet. Speed is adjustable. It has a longer neck and is stronger than BEW 309 E, so it is suitable for larger countersinks and holes. It is ideal for deburring internal cross holes in hard-to-reach areas.

Included accessories

HSS countersink Ø 15 mm
Hexagonal shaft 6.3 mm for countersink range / hole Ø 3.5–14 mm
Order no. 001 950 294

Hose unit
Order no. 001 366 548

Please operate with 2–3 drops of oil per minute at 6 bar.

Speed [rpm]: 0–500
Power [watts]: 80



Optional accessories

HSS countersink Ø 15 mm, for countersinking range / hole Ø 3.5–14 mm
Order no. 001 950 295

HSS countersink Ø 25.5 mm, for countersinking range / hole Ø 5–24 mm
Order no. 001 950 296

Connection set
Order no. 007 899 116
(without hose unit)
For details, see page 61

BEW 605 K
Order no. 150 810 931

Like the BEW 605, but shorter. This machine ensures a better force lever effect when deburring internal cross holes that are not as deep.

Included accessories

Collet, 6 mm

Collet wrench,

Hose unit
Order no. 001 366 548

Please operate with 2–3 drops of oil per minute at 6 bar.

Speed [rpm]: 0–600
Power [watts]: 80



Optional accessories

Connection set
Order no. 007 899 116
(without hose unit)
For details, see page 61

BEW 606 K
Order no. 150 810 927

Like the BEW 606, but shorter. This machine ensures a better force lever effect when deburring internal cross holes that are not as deep.

Included accessories

HSS countersink Ø 15 mm
Hexagonal shaft 6.3 mm for countersink range / hole Ø 3.5–14 mm
Order no. 001 950 294

Hose unit
Order no. 001 366 548

Please operate with 2–3 drops of oil per minute at 6 bar.

Performance countersinks

These countersinks are specially coated tools for machining high-strength steel.

Countersink material	HSS	Carbide	HSS	HSS	HSS
Countersink diameter [mm]	8	8	12	15	15
Countersink range / hole diameter [mm]	2–6	2–6	2.5–10	3.5–14	3.5–14
Shaft dimension [mm]	3/hex	3/hex	3/hex	6.3/hex	Ø6
Order no.	On request	On request	On request	001 950 345	001 950 351
For machine type	BEW 309	BEW 309	BEW 309	BEW 606 / BEW 606K	BEW 605 / BEW 605K

Model	BEW 309 E (BEW 309 EL 150)	BEW 606	BEW 606 K	BEW 605	BEW 605 K	BEW 603*
Valve	Lever valve	Lever valve	Lever valve	Lever valve	Lever valve	Lever valve
Exhaust air direction	backwards	backwards	backwards	backwards	backwards	backwards
Speed [rpm]	0–900	0–600	0–600	0–500	0–500	0–300
Power [watts]	20	80	80	80	80	80
Air consumption [l/min]	150	300	300	300	300	300
Noise level [dB(A)]	71	71	71	71	71	71
Weight [g]	240 (260)	810	630	820	620	630
Max. tool shaft diam. [mm]	3 (hex)	6.3 (hex)	6.3 (hex)	6	6	6.3 (hex)
Max. hole Ø [mm]	10	14	14	24	24	14
Countersink Ø [mm]	8 / 12	15	15	15 / 25	15 / 25	15

*BEW 603: Order no. 150 810 926 / hose unit 001 366 548 (incl.)

Special oil for all machines that require oiled compressed air. Order no. 001 365 665 1.0 I // order no. 001 365 605 5.0 I



Speed [rpm]: 0–900
Power [watts]: 20



Optional accessories

HSS countersink Ø 6.5 mm for countersinking range / Hole Ø 2–5.5 mm, order no. 001 950 292

Connection set
Order no. 007 899 116
(without hose unit)
For details, see page 61



BE 309
Order no. 150 800 710

Small, lightweight and convenient with a push-start feature and speed regulation.

Included accessories

Collet ZG 5 / 3mm
Order no. 001 999 985
For other sizes, see page 62

Collet wrench,
size 6+8
Order no. 007 899 751

Hose unit
Order no. 001 366 549

Please operate with 2–3 drops of oil per minute at 6 bar.

Speed [rpm]: 0–550
Power [watts]: 200



Optional accessories

HSS countersink Ø 30 mm for countersinking range / hole Ø 6–29 mm
Order no. 001 950 341



Connection set
Order no. 007 899 116
(without hose unit)
For details, see page 61



BE 1005
Order no. 150 800 800

The most powerful BIAx drilling deburrer. With a push-start feature and speed regulation. With optional two-handed grip for better manoeuvrability and less strain.

Included accessories

Collet ZG 8 / 10 mm
Order no. 001 999 975
For other sizes, see page 62

Collet wrench,
size 14+17
Order no. 007 899 721

Hose unit
Order no. 001 366 578

Please operate with 2–3 drops of oil per minute at 6 bar.

Speed [rpm]: 0–900
Power [watts]: 20



Optional accessories

HSS countersink Ø 6.5 mm for countersinking range / Hole Ø 2–5.5 mm, order no. 001 950 292

Connection set
Order no. 007 899 116
(without hose unit)
For details, see page 61

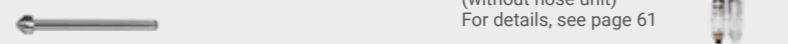

BEG 309
Order no. 150 800 745

Like the BE 309, but with the lever valve (no push start).

Included accessories

Collet ZG 5 / 3mm
Order no. 001 999 985
For other sizes, see page 62

Collet wrench,
size 6+8
Order no. 007 899 751

Hose unit
Order no. 001 366 549

Please operate with 2–3 drops of oil per minute at 6 bar.

Speed [rpm]: 0–500
Power [watts]: 80

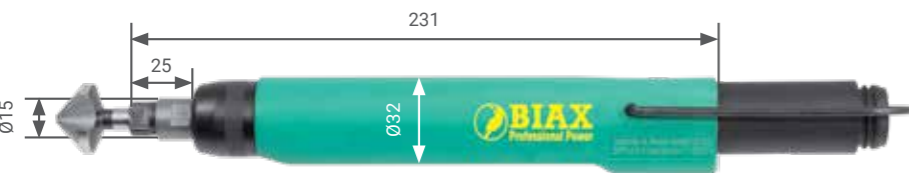

Optional accessories

HSS countersink Ø 15 mm for countersinking range / hole Ø 3.5–14 mm
Order no. 001 950 290

HSS countersink Ø 25 mm for countersinking range / hole Ø 5–24 mm
Order no. 001 950 291

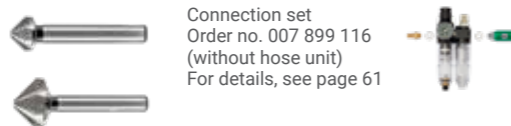

Connection set
Order no. 007 899 116
(without hose unit)
For details, see page 61

BE 805
Order no. 150 810 901

A universal device with push-start feature and speed regulation. Compact yet powerful.

Included accessories

Collet ZG 7 / 8mm
Order no. 001 999 980
For other sizes, see page 62

Collet wrench,
size 11+14
Order no. 007 899 747

Hose unit
Order no. 001 366 548

Please operate with 2–3 drops of oil per minute at 6 bar.

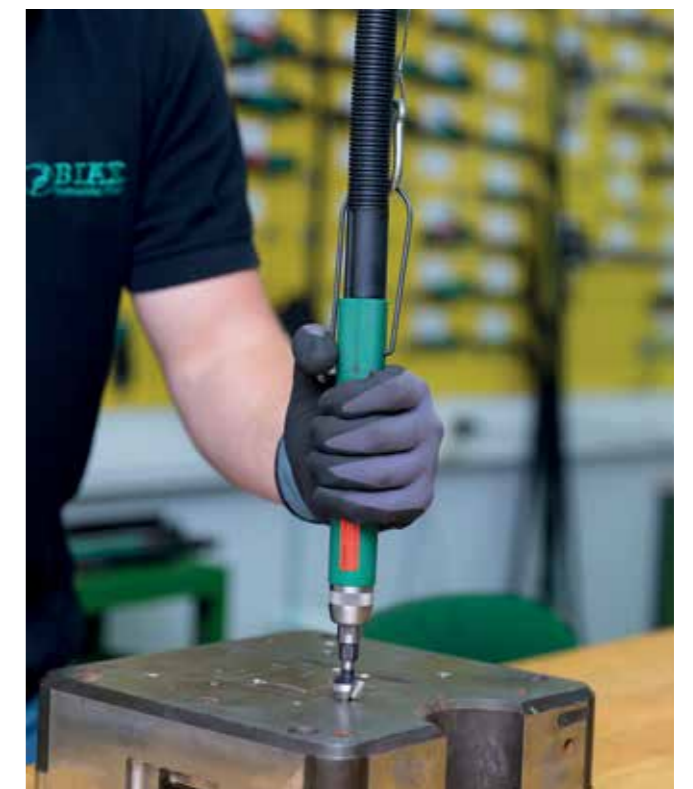

All straight drilling deburrers can be operated with a spring balancer.

Model	BE 309	BEG 309	BE 805	BE 1005
Valve	Push-start feature	Lever valve	Push-start feature	Push-start feature
Exhaust air direction	backwards	backwards	backwards	backwards
Speed [rpm]	0–900	0–900	0–500	0–550
Power [watts]	20	20	80	200
Air consumption [l/min]	150	150	280	450
Noise level [dB(A)]	71	71	71	76
Weight [g]	180	250	520	920
Max. tool shaft diam. [mm]	3	3	8	10
Max. hole Ø [mm]	5.5	5.5	24	29
Countersink Ø [mm]	6	6	15 / 25	30



Spring balancer with steel wire rope

Capacity (kg)	cable length (m)	Order no.
0,3 - 1,5	1,2	001 620 021
0,5 - 2,0	2,0	001 620 022

Special oil for all machines that require oiled compressed air. Order no. 001 365 665 1.0 I // order no. 001 365 605 5.0 I



07 Pneumatic files

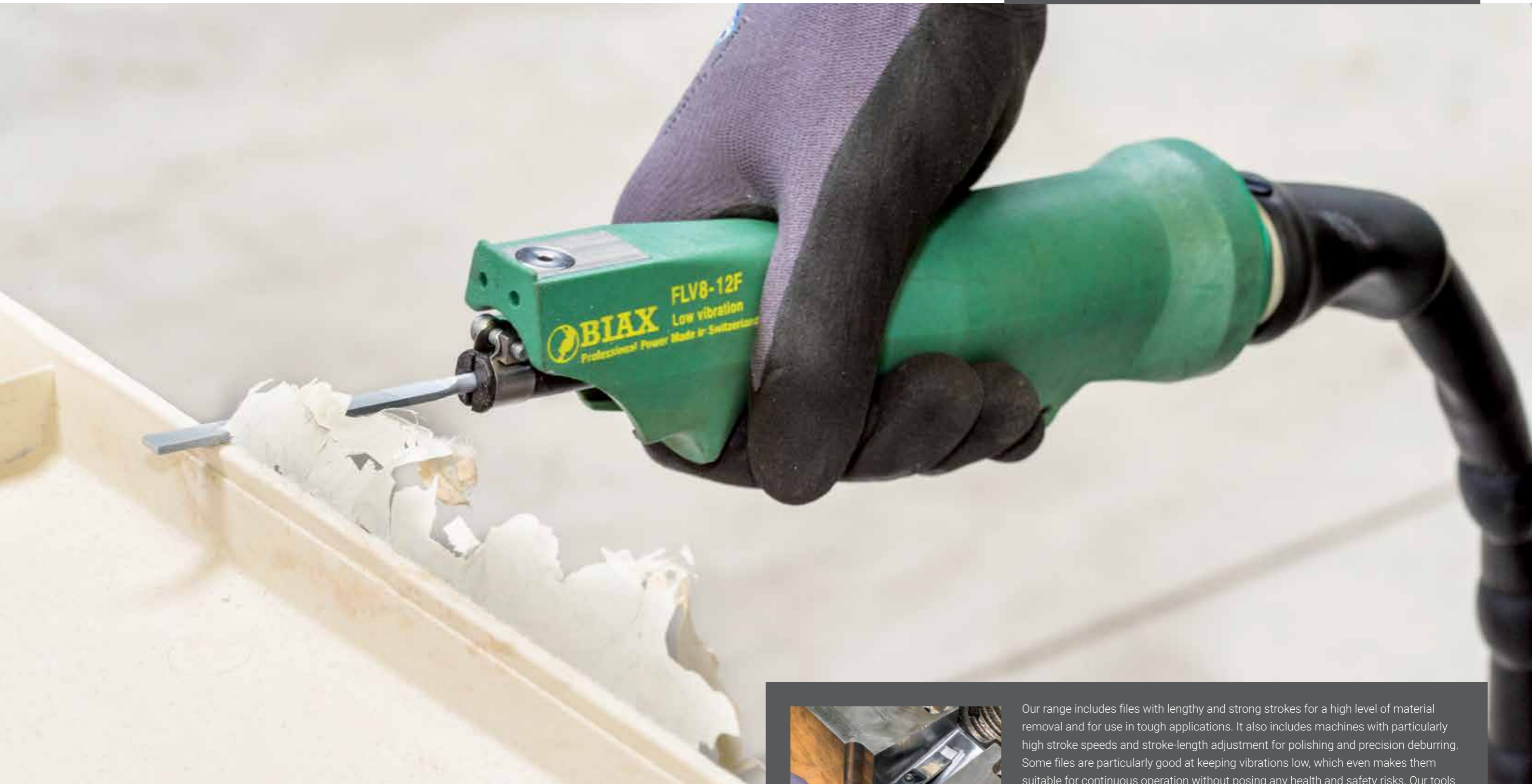

Our range includes files with lengthy and strong strokes for a high level of material removal and for use in tough applications. It also includes machines with particularly high stroke speeds and stroke-length adjustment for polishing and precision deburring. Some files are particularly good at keeping vibrations low, which even makes them suitable for continuous operation without posing any health and safety risks. Our tools are highly versatile and can be used for deburring, polishing or sawing. The BIAX files are manufactured at our Swiss production facility in Neuhausen am Rheinfall.



Vibration-damped files

07 Pneumatic files

Stroke length [mm]: 4–9
Strokes per minute: 12,000

VIBRATION-DAMPED



FLV 8-12 F
Order no. 150 322 874

This is a vibration-damped machine, which makes it ideal for continuous operation for polishing or deburring. The stroke length can be adjusted, and the exhaust air direction can be changed in order to blow grinding dust forwards.

Included accessories

- Plastic case
- 5 different files + polishing instrument
- Tool holder 3, 4 and 6 mm
- Counterholder
- 4 different saw blades
- Air supply hose
Order no. 001 974 552

Please operate with 1 drop of oil per minute at 6 bar.

Optional accessories

- Files: all files with 3 mm, 4 mm and 6 mm shaft (see page 48/49)
- Tool holder (see page 48/49)
- Counterholder (see page 48/49)
- Connection set
Order no. 007 899 116 (without hose unit)
For details, see page 61

Stroke length [mm]: 4
Strokes per minute: 9,000

VIBRATION-DAMPED

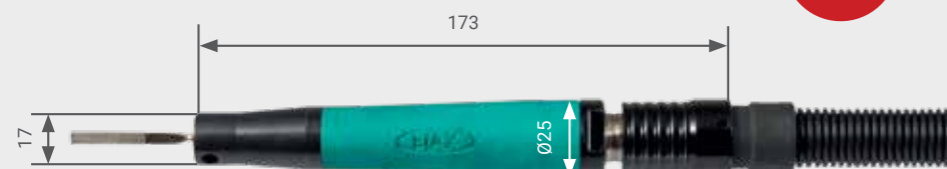

FLV 4-9
Order no. 150 322 785

Extremely low-vibration machine. Convenient deburring file for small components that have to be held by hand while being deburred. Perfect for applications in which only a very small level of material removal is required.

Included accessories

- Tool holder, 3 mm
- Hexagon spanner, size 2
- Air supply hose
Order no. 001 366 595

Please operate with 2–3 drops of oil per minute at 6 bar.

Optional accessories

- Files: all files with 3 mm shaft (see page 48/49)
- Connection set
Order no. 007 899 116 (without hose unit)
For details, see page 61
- Vario-holder
Order no. 007 012 848

07 Pneumatic files

Stroke length [mm]: 0.8
Strokes per minute: 17,000

VIBRATION-DAMPED



FLV 1-20
Order no. 150 322 780

Extremely low-vibration machine. Designed for fine polishing of moulds. High stroke speed combined with short strokes enable controlled machining of surfaces. This reduces the likelihood of damaging the mould. The tool is also suitable for the most delicate deburring work.

Included accessories

- Hexagon spanner, size 2+2,5
- Tool holder, 3 mm
- Polishing stone holder, 3–6 mm
Order no. 001 974 457
- Air supply hose
Order no. 001 366 595

Please operate with 2–3 drops of oil per minute at 6 bar.

Optional accessories

- Files: all files with 3 mm (see page 48/49)
- Polishing stones (see the BIAX accessories catalogue)
- Connection set
Order no. 007 899 116 (without hose unit)
For details, see page 61
- Vario-holder
Order no. 007 012 848

Model	FLV 8-12 F	FLV 4-9	FLV 1-20
Power [watts]	300	80	80
Valve	Lever valve	Slide valve	Slide valve
Exhaust air direction	backwards	backwards	backwards
Strokes per minute	12,000	9,000	17,000
Stroke length [mm]	2–8	4	0.8
Air consumption [l/min]	250–300	80	80
Noise level [dB(A)]	70	66	63
Weight [g]	700	260	260
Max. tool shaft diam. [mm]	6	3	3
Integrated tool holder	4 mm	3 mm	3 mm



Special oil for all machines that require oiled compressed air. Order no. 001 365 665 1.0 l // order no. 001 365 605 5.0 l



01 Straight grinders high speed & oil-free
02 High speed straight grinders
03 Straight grinders
04 Angle grinders
05 Belt sanders
06 Drilling deburrers
07 Pneumatic files
08–11 Brushing tools / chisels / pneumatic saws / drills
12 Accessories



Stroke length [mm]: 10
Strokes per minute: can be regulated up to 5,500



FR 10-5/2
Order no. 150 930 220

A strong and robust machine with adjustable speed for rough work.

Included accessories

- Installation wrench
- Clamping screw
- Hose unit
Order no. 001 964 528

Please operate with 2-3 drops of oil per minute at 6 bar.

Optional accessories

Files: all files with 6 mm shaft (see page 48/49)
Saw blades (see page 59)

Counterholder (see page 48/49)

Connection set
Order no. 007 899 116 (without hose unit)
For details, see page 61



Stroke length [mm]: can be regulated between 1 and 5
Strokes per minute: 0-8,000



FR 5-8
Order no. 150 322 830

Machine with adjustable speed and stroke length. The file holder can be rotated during operation. Constant stroke length even under high loads.

Included accessories

- Installation wrench
- Clamping screw
- Hose unit
Order no. 001 366 571

Please operate with 2-3 drops of oil per minute at 6 bar.

Optional accessories

Files: all files with 3 mm, 3.8 mm and 4 mm shaft (see page 48/49)

Connection set
Order no. 007 899 116 (without hose unit)
For details, see page 61



Stroke length [mm]: 8
Strokes per minute: 2,000



FR 8-2
Order no. 150 322 611

The most powerful BIAX file in the range. A constant stroke length even under extreme loads.

Included accessories

- Collet ZG 4 / 6 mm
Order no. 001 999 990
For other sizes, see page 62
- Collet wrench, size 9+11
Order no. 007 899 874

Please operate with 2-3 drops of oil per minute at 6 bar.

Optional accessories

Files: all files with 6 mm shaft (see page 48/49)

Counterholder (see page 48/49)

Connection set
Order no. 007 899 101 (without hose unit)
For details, see page 61

Hose unit
Order no. 001 366 505

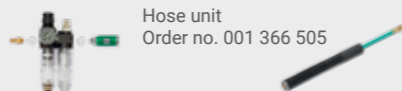

Stroke length [mm]: 3 or 5
Strokes per minute: 0-8,000



FR 3-8
Order no. 150 322 730
FR 5-8 N
Order no. 150 322 735

Like FR 5-8 N, but the file holder cannot be rotated and the stroke length is not adjustable. The stroke length is fixed at 3 mm or 5 mm.

Included accessories

- Installation wrench
- Clamping screw
- Hose unit
Order no. 001 366 571

Please operate with 2-3 drops of oil per minute at 6 bar.

Optional accessories

Files: all files with 3 mm, 3.8 mm and 4 mm shaft (see page 48/49)

Connection set
Order no. 007 899 116 (without hose unit)
For details, see page 61



FR 5-8 with rotating file holder



Model	FR 10 5/2	FR 8-2	FR 5-8 N	FR 3-8	FR 5-8
Valve	Lever valve	Lever valve	Lever valve	Lever valve	Lever valve
Exhaust air direction	backwards	backwards	backwards	backwards	backwards
Strokes per minute	adjustable up to 5,500	2,000	0-8,000	0-8,000	0-8,000
Stroke length [mm]	10	8	adjustable between 1 and 5	3	5
Air consumption [l/min]	280	310	230	230	230
Noise level [dB(A)]	72	73	72	72	72
Weight [g]	750	1250	800	720	720
Max. tool shaft diam. [mm]	6	6	4	4	4



Special oil for all machines that require oiled compressed air. Order no. 001 365 665 1.0 l // order no. 001 365 605 5.0 l



01 Straight grinders high speed & oil-free
02 High speed straight grinders
03 Straight grinders
04 Angle grinders
05 Belt sanders
06 Drilling deburrers
07 Pneumatic files
08-11 Brushing tools / chisels / pneumatic saws / drills
12 Accessories

Tool holders and polishing instruments



Tool holder for FR 8-12, FLV 8-12, PLF 88, PLF 90, PS 1, PS 8

Tool shaft diam. [mm]	3	4	6
Order no.	001 974 430	001 974 411	001 974 443

Counterholder (for use as a saw) – see page 59

Polishing stone holders



Small, lightweight polishing stone holder with a 3 mm shaft. Suitable for all BIAx files (except FR 10-5/2).
Span width: 1–6 mm

Order no. 001 974 457



Large polishing stone holder for FR 8-12, PS1, PLF88, PLF90, FLV 8-12F, PS8
Span width 3–6 mm

Order no. 007 011 295

Polishing instruments

Thanks to the tough material used for the polishing instruments, material can be removed very quickly.

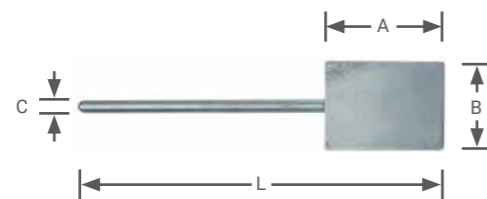

Dimension A [mm]	35	20	20
Dimension B [mm]	25	20	11
Dimension L [mm]	110	140	140
Shaft C [mm]	4	4	4
Order no.	001 974 436	001 974 437	001 974 438

The sanding strips are simply attached to the polishing instrument.

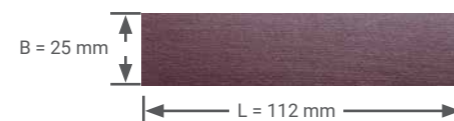

Sanding strips for polishing instrument, self-adhesive

Grit size	80	120	240	400
Order no.	001 974 439	001 974 440	001 974 441	001 974 442

10-piece pack

BIAx files Straight version



Shaft \varnothing 3 mm, usable length 70 mm, total length 140 mm. Suitable for BIAx compressed air files: FR 3-8, FR 5-8 (N), FR 8-12, FLV 8-12, PLF 88, FLV 4-9, FLV 1-20

Profile	—	■	▲	◐	◑	●
Usable length [mm]	70	80	70	70	-	80
Width x height [mm]	6,0 x 1,3	2,4 x 2,4	3,6 x 3,6	5,0 x 1,7	-	\varnothing 3
Total length [mm]	115	120	105	105	-	115
Cut 1 (coarse) order no.	001 621 833	001 621 835	001 621 834	001 621 837	-	001 621 836



Shaft \varnothing 3 mm, usable length 70 mm, total length 140 mm. Suitable for BIAx compressed air files: FR 3-8, FR 5-8 (N), FR 8-12, FLV 8-12, PLF 88, FLV 4-9, FLV 1-20

Profile	—	■	▲	◐	◑	●
Width x height [mm]	5,1 x 1,3	2,4 x 2,4	3,5 x 3,5	5,0 x 1,7	-	\varnothing 3
Cut 1 (coarse) order no.	001 621 823	001 621 827	001 621 825	001 621 831	-	001 621 829
Cut 3 (fine) order no.	001 621 824	001 621 828	001 621 826	001 621 832	-	001 621 830

Shank \varnothing 3.8 mm, usable length 60 mm. Suitable for BIAx compressed air files: FR 3-8, FR 5-8 (N), FR 8-12, FLV 8-12, PLF 88

Profile	—	■	▲	◐	◑	●	File set
Width x height [mm]	7 x 2	2.8 x 2.8	4 x 4	6 x 2.5	7.5 x 2	\varnothing 4	(1 piece per profile type)
Cut 1 (coarse) order no.	001 620 837	001 620 838	001 620 839	001 620 840	001 620 841	001 620 842	300 000 500
Cut 3 (fine) order no.	001 620 849	001 620 850	001 620 851	001 620 852	001 620 853	001 620 854	300 002 000

Shaft \varnothing 6 mm – with a usable length of 80 mm.

Suitable for BIAx pneumatic files: FR 3-8, FR 10-5, FLV 8-12, FR 8-2

Profile	—	■	▲	◐	◑	●	File set
Width x height [mm]	12 x 6	8 x 8	9 x 9	10 x 5	12 x 6	\varnothing 6	(1 piece per profile type)
Cut 1 (coarse) order no.	001 620 801	001 620 802	001 620 803	001 620 804	001 620 805	001 620 806	300 000 300
Cut 3 (fine) order no.	001 620 813	001 620 814	001 620 815	001 620 816	001 620 817	001 620 818	300 001 700



Shaft \varnothing 4 mm. Suitable for BIAx pneumatic files: FR 3-8, FR 5-8(N), FR 8-12, FLV 8-12, PLF 88

Profile	—	■	▲	◐	◑	●	File set
Length [mm]	90	90	65	90	90	90	90
Width x height [mm]	6.5 x 2	10 x 3	15 x 3	\varnothing 4	\varnothing 6	6.5 x 2.5	10 x 3
Cut (coarse) order no.	001 620 202	001 620 203	001 620 204	001 620 213	-	001 620 207	001 620 205
Cut (medium) order no.	001 620 201	-	-	001 620 210	001 620 211	001 620 206	-

Curved models



Shaft \varnothing 3.8 mm – with a usable length of 65 mm. Suitable for BIAx pneumatic files: FR 3-8, FR 5-8(N), FR 8-12, FLV 8-12, PLF 88

Profile	—	■	▲	◐	◑	●	File set
Width x height [mm]	7 x 2	3.5 x 3.5	4 x 4	6 x 2.5	7.5 x 2	\varnothing 4	(1 piece per profile type)
Cut 2 (medium) order no.	001 620 879	001 620 880	001 620 881	001 620 882	001 620 883	001 620 884	300 000 700
Cut 1 (coarse) order no.	001 620 885	-	-	-	-	-	-

BIAx diamond files

Straight models



Shaft \varnothing 3 mm – with a usable length of 25 mm. Suitable for BIAx pneumatic files: FR 3-8, FR 5-8 (N), FR 5-4, FR 8-12, FLV 8-12, PLF 88, FLV 4-9, FLV 1-20

Profile	—	■	▲	◐	◑	●	File set
Width x height [mm]	5 x 2	4 x 4	3 x 3	6 x 3	\varnothing 2	\varnothing 4	(1 piece per profile type)
D100 grain order no.	001 620 861	001 620 862	001 620 863	001 620 864	001 620 865	001 620 866	300 000 600



Special oil for all machines that require oiled compressed air. Order no. 001 365 665 1.0 I // order no. 001 365 605 5.0 I



08 Brushing tools

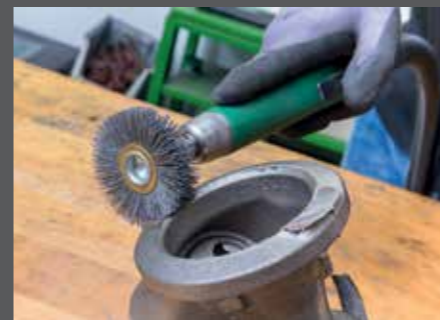

Our drills are lightweight yet powerful and feature an ergonomic handle. They also offer a number of different speed settings.

The brushing tools are available in straight or angled models, boasting low operating speeds and a high level of torque. These are particularly suitable for removing loose burrs or cleaning surfaces.

Speed [rpm]: 500
Power [watts]: 80

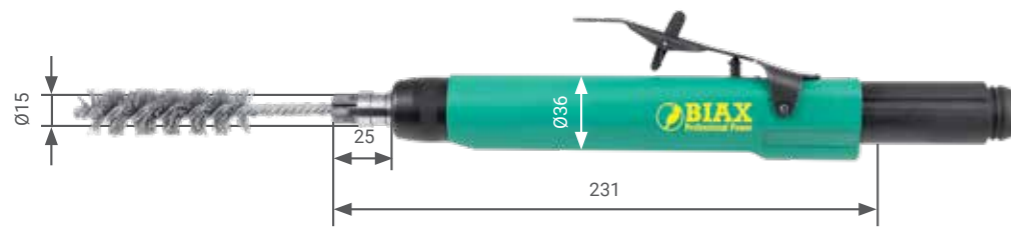

Optional accessories

Connection set
Order no. 007 899 116
(without hose unit)
For details, see page 61



BE 805 H
Order no. 150 810 915

Ideal for the use of handled brushes for cleaning drilled holes. It offers the option of switching between clockwise and anti-clockwise rotation, thus ensuring even more effective removal of burrs.

Included accessories

Collet
ZG 7 / 8 mm
Order no. 001 999 980
For other sizes, see page 62

Collet wrench,
size 11+14
Order no. 007 899 746

Hose unit
Order no. 001 366 548

Please operate with 2-3 drops of oil per minute at 6 bar.

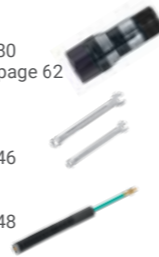

Speed [rpm]: 10,000
Power [watts]: 280



Optional accessories

Vario-holder
Order no. 007 012 848



Connection set
Order no. 007 899 101
(without hose unit)
For details, see page 61



Hose unit
Order no. 001 366 505



Please operate with 2-3 drops of oil per minute at 6 bar.

Included accessories

Collet
ZG 7 / 8 mm
Order no. 001 999 981
For other sizes, see page 62

Collet wrench,
size 11+14
Order no. 007 899 747



Speed [rpm]: 2,500
Power [watts]: 300



Optional accessories

Connection set
Order no. 007 899 103
(incl. hose unit)
For details, see page 61



Hose unit
Order no. 001 366 578



BWH 6-25/2 K90
Order no. 150 222 310

For drilling and brushing in hard-to-reach areas. It features a 90° angled head with a robust gear unit for high durability.

Included accessories

Collet
ZG 4 / 6 mm
Order no. 001 999 990
For other sizes, see page 62

Collet wrench,
size 9+11
Order no. 007 899 874

Please operate with 2-3 drops of oil per minute at 6 bar.

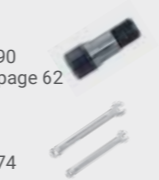

Wann Komma? 2,500 statt 2500 ?

Model	BE 805 H	BWH 6-25/2 K90	BWH 6-25/2 K45	SRH 8-10
Valve	Lever valve	Lever valve	Lever valve	Lever valve
Exhaust air direction	backwards	backwards	backwards	backwards
Front bearing set				double
Strokes per minute	500	2500	2500	10000
Power [watts]	80	300	300	280
Air consumption [l/min]	280	500	500	300
Noise level [dB(A)]	71	75	75	67
Weight [g]	570	1220	1240	645
Max. tool shaft diam. [mm]	8	6	6	8
Max. tool Ø [mm]				
Carbide tools				16

Please note the information from the grinding tool manufacturer.

Brushes

Steel brushes with corrugated steel wire:

- for deburring, derusting and cleaning weld seams
- suitable for steel and cast iron
- high wear resistance
- high dimensional stability



Model	Round brush Ø 60	Round brush Ø 30	Topfbürste Ø 60	Topfbürste Ø 40	Pinselbürste Ø 22	Pinselbürste Ø 16	Pinselbürste spitz Ø 12
Durchmesser x Breite [mm]	60 x 15	30 x 7	-	-	-	-	-
Durchmesser [mm]	-	-	60	40	22	16	12
Schaftdurchmesser [mm]	6	6	6	6	6	6	6
Max. Drehzahl [mm ⁻¹]	15.000	20.000	8.000	10.500	12.500	15.000	20.000
Wire strength [mm]	0,25	0,15	0,3	0,3	0,2	0,2	0,3
Order no.	001 622 709	001 622 702	001 625 234	001 625 232	001 625 231	001 625 230	001 625 229

You can find a larger selection of brushes in our accessories catalog.



Special oil for all machines that require oiled compressed air. Order no. 001 365 665 1.0 I // order no. 001 365 605 5.0 I





09 Chisels and engraving tools

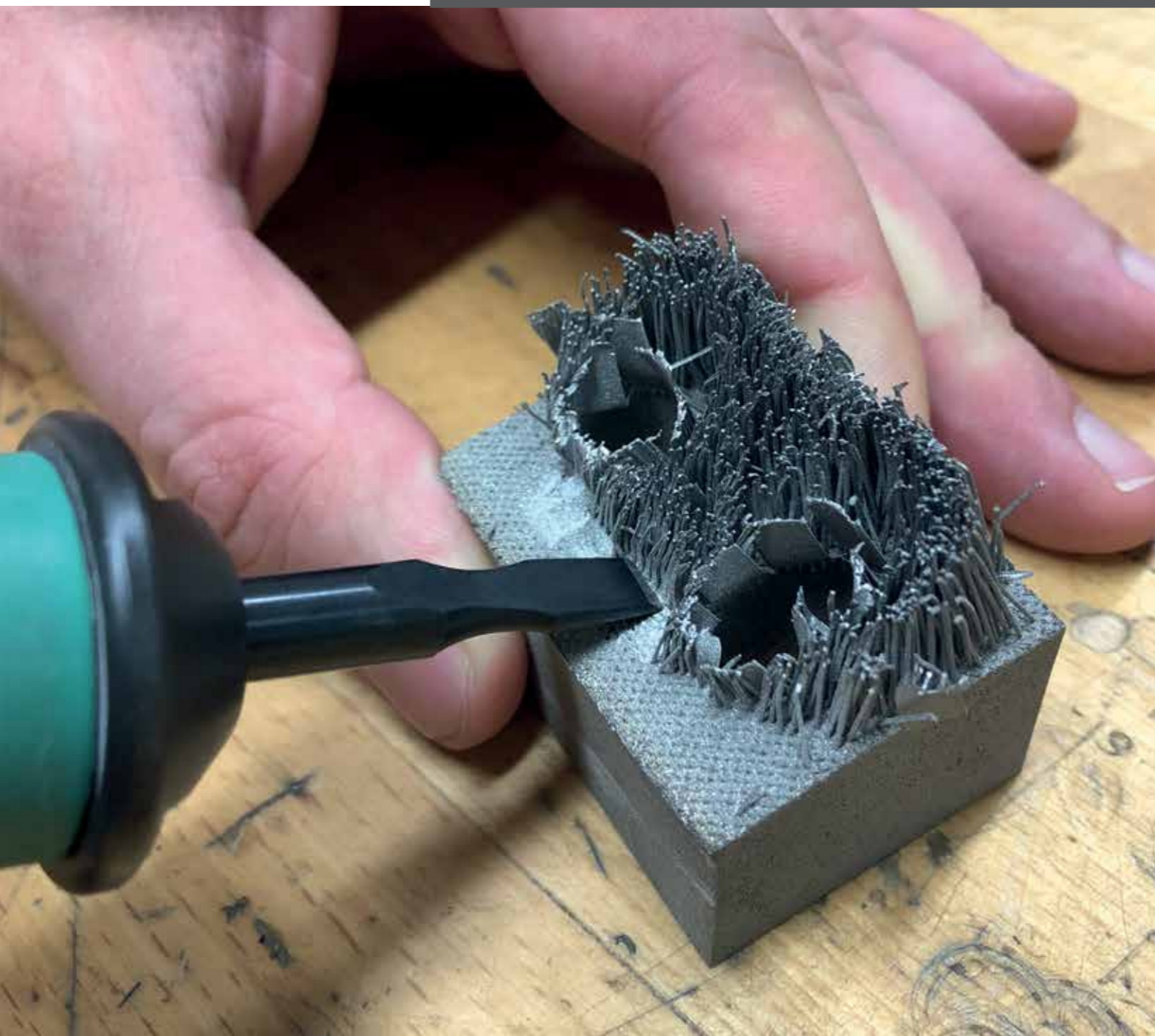

These tools are ideal for post-processing of 3D-printed parts, removing welding residues and engraving.



MD 100 Order no. 150 800 310

A powerful pneumatic chisel for tough applications, such as removing welding beads or supporting structures when post-processing 3D-printed parts.

Included accessories

Hose unit
Order no. 001 366 595



 Please operate with 1-2 drops of oil per minute at 6 bar.

Optional accessories

Connection set
Order no. 007 899 116
(not including hose unit)
For details, see page 61



Chisel:

Flat chisel, narrow, w 6 mm
Order no. 001 963 529

Flat chisel, wide, w 12.5 mm
Order no. 001 963 531

Flat chisel, slanted, w 9 mm
Order no. 001 963 530



GMD 3 Order no. 150 800 301

Small and lightweight tool for engraving and light chiselling. Fits in your hand like a pencil while engraving.

Included accessories

Extender

Flat chisel, narrow, w 3 mm
Order no. 003 000 730

Flat chisel, wide, w 5 mm
Order no. 003 000 463

Groove chisel, w 1 mm
Order no. 003 000 895

Hex slug, w 3 mm
Order no. 003 000 979

Stylus
Order no. 007 001 184

Chisel set, complete Order no. 007 000 979

 Please operate with 1-2 drops of oil per minute at 6 bar.

Optional accessories

Connection set
Order no. 007 899 106
(incl. hose unit)
For details, see page 61



Hose unit
Order no. 001 366 539



Model	MD 100	GMD 3
Valve	Rotary valve	Rotary valve
Exhaust air direction	backwards	forwards
Strokes per minute	3000	3000
Air consumption [l/min]	130	80
Noise level [dB(A)]	65	80
Weight [g]	530	100
Max. tool shaft diam. [mm]	6 (hex)	3 (hex)



Special oil for all machines that require oiled compressed air. Order no. 001 365 665 1.0 l // order no. 001 365 605 5.0 l



10 Pneumatic saws



Our pneumatic saws are ideal for cutting work on car bodies and sheet steel. Our range also includes the right saw blades for other materials, such as aluminium, non-ferrous metals, plastic, wood or composites. Our pneumatic saws are based on the legendary SIG-model saws and are manufactured at our Swiss production facility in Neuhausen am Rheinfall.

10 Pneumatic saws

Power [watts]: 280

Please operate with 1 drop of oil per minute at 6 bar.



Optional accessories

Counterholder (see page 59)	Saw blades (see page 59)	Connection set Order no. 007 899 116 (without hose unit) For details, see page 61
--------------------------------	-----------------------------	--



PS 2 PLUS
Order no. 150 322 922

Rugged and attractive basic model featuring an innovative fixing system for saw blades which prevents the blade from being pulled out inadvertently (e.g. when the saw blade catches against something).

Included accessories

Plastic case
2 Installation wrenches

Counterholder
Order no. 003 012 066

Tool holder
4 mm (integrated)
Order no. 008 012 314

4 saw blades
14/18/24/32 TPI

Air supply hose
Order no. 001 974 552



Power [watts]: 300

Please operate with 1 drop of oil per minute at 6 bar.



Optional accessories

Counterholder (see page 59)	Saw blades (see page 59)	Connection set Order no. 007 899 116 (without hose unit) For details, see page 61
--------------------------------	-----------------------------	--

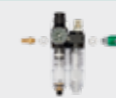

PS 3
Order no. 150 322 921

Like the PS 2 Plus, but also includes vibration damping, so you can continue working without fatigue.

Included accessories

Plastic case
2 Installation wrenches

Counterholder
Order no. 003 012 066

Tool holder, 4 mm
(integrated)
Order no. 008 012 314

4 saw blades
14/18/24/32 TPI

Air supply hose
Order no. 001 974 552



Power [watts]: 300

Please operate with 1 drop of oil per minute at 6 bar.



Optional accessories

Counterholder (see page 59)	Saw blades (see page 59)	Connection set Order no. 007 899 116 (without hose unit) For details, see page 61
--------------------------------	-----------------------------	--



PLF 90
Order no. 150 322 890

Like the PS 2 PLUS, but even more robust and powerful for the toughest applications. Only suitable for conventional saw blades.

Included accessories

Plastic case
2 Installation wrenches

Counterholder
Order no. 003 012 066

Tool holder
4 mm (integrated)
Order no. 001 974 411

4 saw blades
14/18/24/32 TPI

Air supply hose
Order no. 001 982 531



Special oil for all machines that require oiled compressed air. Order no. 001 365 665 1.0 I // order no. 001 365 605 5.0 I



01 Straight grinders
high speed & oil-free

02 High speed
straight grinders

03 Straight grinders

04 Angle grinders

05 Belt Sanders

06 Drilling deburrers

07 Pneumatic files

08-11 Brushing tools / chisels
/ pneumatic saws / drills

12 Accessories

57

56

Saw blades

Our saw blades:

- set high standards in terms of service life and efficiency
- deliver the very best cutting performance
- are extremely flexible and resistant to breakage



The teeth are made from high-quality HS steel. The supporting material is made from special spring steel which has been subject to specific heat treatments to ensure maximum flexibility, resilience and freedom from fatigue.

For PS 25, PS 2, PS 3

Saw blade length [mm] L	60	60	60	60
Tooth spacing [mm] T	0.8	1.0	1.4	1.8
Number of teeth	32 TPI*	24 TPI*	18 TPI*	14 TPI*
Order no.	007 012 393	007 012 392	007 012 391	007 012 390
Applications	Thin sheet metal and high-strength steel up to 1.5 mm	Double and triple sheet metal up to 1.5 mm	Aluminium, plastic	Wood, composites, plastic

*TPI = teeth per inch



For PS 1, PS 8, PLF 90

Saw blade length [mm] L	96	96	96	72
Tooth spacing [mm] T	0.8	1.0	1.8	1.4
Number of teeth	32 TPI*	24 TPI*	14 TPI*	18 TPI*
Order no.	001 974 432	001 974 433	001 974 434	001 974 435
Applications	All thin sheet metal Sheet steel up to 1.0 mm	Sheet steel up to 3.0 mm, aluminium up to 1.5 mm, chromium sheet steel up to 1.5 mm	Aluminium, non-ferrous metal up to 4 mm, wood, chipboard	Specially designed for sawing with narrow curve radii

*TPI = teeth per inch



For FR 10-5/2

Saw blade length [mm] L	90	90	90
Tooth spacing [mm] T	0.8	1.0	1.4
Number of teeth	32 TPI*	24 TPI*	18 TPI*
Order no.	001 974 445	001 974 446	001 974 447
Applications	All thin sheet metal Sheet steel up to 1.0 mm	Sheet steel up to 3.0 mm, aluminium up to 1.5 mm, chromium sheet steel up to 1.5 mm	Non-ferrous metal, aluminium, wood, chipboard

*TPI = teeth per inch



Counterholder

The counterholder is used to stabilise the workpiece or to adjust the cutting depth of the saw blades.



Counterholder for	FR 8-12 / PS1	PLF 88 / PLF 90	FLV 8-12 / PS 8	FR 10-5/2
Order no.	001 974 418	001 974 542	001 974 623	001 964 532

The counterholder is required when the machine is used as a saw in order to support the machine against the workpiece. The holder can also be adjusted to limit the cutting depth of the saw blade without set increments.

Model	PS 2 PLUS	PS 3	PLF 90
Power [watts]	280	300	300
Valve	Lever valve	Lever valve	Lever valve
Exhaust air direction	backwards	backwards	backwards
Strokes per minute	12,000	12,000	12,000
Stroke length [mm]	8	8	8
Air consumption [l/min]	250	250	250
Noise level [dB(A)]	73	73	71
Weight [g]	720	980	760
Max. tool shaft diam. [mm]	4	4	6

11 Drills



Speed [rpm]: 500–6,000
Power [watts]: 160

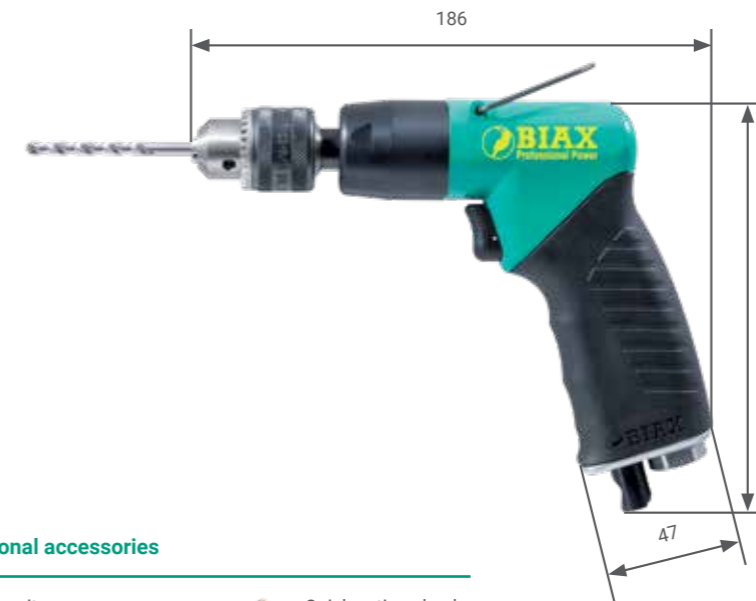

Optional accessories

Hose unit
Order no. 001 366 824

Quick-action chuck

BP 1000
Order no. 150 210 300
BP 2600
Order no. 150 210 000

Lightweight and ergonomic drills with six different speed settings. These feature a soft-start system and adjustable exhaust air nozzle. Also available with a quick-action chuck.

Included accessories

Chuck key

Please operate with 2–3 drops of oil per minute at 6 bar.

Model	BP 1000	BP 2600
Speed [rpm]	1,000	2,600
Power [watts]	160	160
Air consumption [l/min]	450	450
Noise level [dB(A)]	74	75
Weight [g]	740	700
Max. clamping Ø [mm]	8	8
Connecting thread	G1/8"	G1/8"
Hose diameter [mm]	7	7

12 Accessories



In the following pages you will find a range of accessories for ensuring the longevity of our pneumatic tools, as well as details on our collets, hose units and connection sets.

Connection set

Connect and get started straight away: Our practical connection set covers all the essentials, so you can use our tools safely and ensure their longevity.

Order no. 007 899 101 - 110

Contents:

- Matching hose unit depending on the machine (1 pc.)
- Maintenance unit, order no. 001 367 024 (1 pc.)
- Safety coupling, order no. 001 366 721 (1 pc.)
- Male connection G1/4" A, order no. 001 367 710 (1 pc.)
- Sealing ring order no. 001 367 616 (2 pc.)

Order no. 007 899 116

For machines with which the hose unit is already included in delivery. Contents as outlined above, but does not include hose unit.

Order no. 007 899 115

For oil-free grinders. The hose unit is already included in delivery for all oil-free grinders. For this reason, it is not included in the connection set.

Contents:

- Air filter, order no. 001 367 023 (1 pc.)
- Safety coupling, order no. 001 366 721 (1 pc.)
- Male connection G1/4" A, order no. 001 367 710 (1 pc.)
- Sealing ring order no. 001 367 616 (2 pc.)

Vario-holder V3

Affords order and safety to your workplace. Your high-quality tool can be placed on the workbench without the risk of falling down. Suitable for almost all BIAX tools thanks to the adjustable internal sleeves. It is compatible with the following models:

- TVD 3-100/2, T 365/2,
- TSD 385, T 3-65 S,
- SRD 3-85/2, SRD 3-85/2D,
- SVD 3-85/2, SVD 3-85/2D,
- SRH 3-85/2, SRH 3-85/2D,
- SVH 3-85/2, SVH 3-85/2D,
- SRD 3-55/2, SRD 3-55/2 S, SRD 3-55/2 KE,
- SRD 6-45/2, SRD 6-45/2 SL, SRD 3-45/2,
- SRH 6-45/2, SRH 6-45/2 SL, SRH 3-45/2,
- SRD 8-30/2, SARD 830, SBRD 830,
- SRH 8-30/2, SARH 830, SBRH 830, SVKH 630,
- SRD 8-30/2 SL, SRD 6-30/2, SRD 3-30/2,
- SRH 8-30/2 SL, SRH 6-30/2,
- SRD 8-20/2, SRH 8-20/2 SL,
- SRH 8-20/2, SRH 8-20/2 SL,
- SARD 820, SARH 820,
- SRH 10-12/2, SRH 8-10,
- FLV 4/9, FLV 1-20

Order no. 007 012 848



With approx. 10% price advantage compared to single purchase!



hanging

standing

Hose unit

Here you can find and place an order for the individual components of our hose units.



Hose unit complete	001 366 505	001 366 528	001 366 594	001 366 595	001 366 548	001 366 549	001 366 577	001 366 578	001 366 580	001 366 576
Male connection included (8)	001 367 711	001 367 712	001 367 711	001 367 711	001 367 711	001 367 711	001 367 711	001 367 711	001 367 712	-
Seal included (9)	001 367 616	001 313 102	001 367 616	001 367 616	001 367 616	001 367 616	001 367 616	001 367 616	001 313 102	-
Hose connector (1)	001 366 207	001 366 202	001 366 207	001 366 216	001 366 207	001 366 216	001 366 207	001 366 207	001 366 202	001 366 610
Hose clamp (2)	001 372 606	001 372 610	001 369 406	001 369 408	001 372 606	001 369 408	001 372 606	001 372 606	001 372 610	001 369 408
Pressure hose (3)	001 366 357	001 366 320	001 366 357	001 366 308	001 366 357	001 366 308	001 366 357	001 366 357	001 366 320	001 366 308
Sound muffler (4)	003 008 026	001 365 014	-	003 008 000	-	-	003 008 023	003 008 026	001 365 014	003 008 000
Exhaust air hose (5)	001 331 142	001 331 142	-	001 331 189	001 331 161	001 331 158	001 331 177	001 331 163	001 331 142	001 331 189
Threaded male connector (6)	003 003 528	003 003 702	-	003 003 447	001 366 204	-	001 366 204	001 366 204	001 366 211	003 006 356
Seal (7)	001 312 205	001 313 103	-	-	001 312 205	-	001 312 205	001 312 205	001 313 303	001 312 202

Products sold by the metre:										
Pressure hose	001 366 356	001 366 318	001 366 356	001 366 309	001 366 356	001 366 309	001 366 356	001 366 356	001 366 318	001 366 309
Exhaust air hose	001 311 143	001 331 143	-	001 331 184	001 331 160	001 331 157	001 331 160	001 331 162	001 331 143	-
Technical data										
Length [m]	3	3	3	1.5	1.5	1.5	3	3	3	1.5
clear width [mm]	7	10	7	4.5	7	4.5	7	7	10	4.5
Weight [kg]	0.5	0.7	0.24	0.11	0.21	0.1	0.4	0.4	0.7	0.11

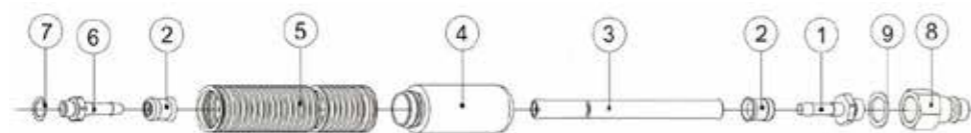

Collets and wrenches



Type	ZG 1	ZG 1 A	ZG 4	ZG 5	ZG 7	ZG 8
	Order no.	Order no.	Order no.	Order no.	Order no.	Order no.
0.5 mm hole	-	-	-	001 999 871	-	-
1.0 mm hole	-	-	001 999 957	001 999 989	001 999 868	-
1.5 mm hole	-	-	001 999 960	001 999 988	-	-
2.0 mm hole	001 999 932	-	001 999 959	001 999 987	001 999 867	-
2.5 mm hole	-	-	001 999 952	001 999 986	-	-
3.0 mm hole	001 999 999	001 999 995	001 999 991	001 999 985	001 999 982	-
3.5 mm hole	-	-	001 999 951	-	001 999 924	-
4.0 mm hole	001 999 998	001 999 949	001 999 961	-	001 999 973	-
5.0 mm hole	001 999 997	-	001 999 958	-	001 999 972	-
6.0 mm hole	001 999 996	001 999 994	001 999 990	-	001 999 981	001 999 977
7.0 mm hole	-	-	-	-	001 999 971	-
8.0 mm hole	-	001 999 993	-	-	001 999 980	001 999 976
10.0 mm hole	-	001 999 992	-	-	-	001 999 975
1/8" hole	-	-	001 999 964	001 999 983	001 999 979	-
1/4" hole	-	-	001 999 965	-	001 999 978	-
3/32" hole	-	-	001 999 970	001 999 984	-	-
Collet wrench	001 365 806 + retaining pin 002 000 069	001 365 811 + retaining pin 002 000 070	007 899 874 (size 9+11 in the set)	007 899 751 (size 6+8 in the set)	007 899 747 (size 11+14 in the set)	007 899 721 (size 14+17 in the set)

Maintenance units

- Robust construction
- High air passage
- 5 µm fine filter for highest air purity
- Container with bayonet lock, easy opening and closing
- Including holder for assembly with venting function



Order no.	001 367 024	001 367 023	001 367 045
Connecting thread	G 1/4"	G 1/4"	G 1/2" / G 3/8"
Max. operating pressure (bar)	10	10	10
Flow rate at 6 bar (l/min)	800	500	1900
Adjustment range (bar)	0.5-10	0.5-10	0.5-8
Weight (kg)	0.81	0.5	1.9

For oil-free pneumatic tools

Safety clutch with venting function



Special oil



Order no. (1.0 l)
001 365 665
Order no. (5.0 l)
001 365 605

One-hand couplings



Connecting thread	G 1/4"	G 3/8"	G 1/4" i	-	-	G 1/8"	G 1/4"	-	-	-
For hose diameter	-	-	-	7	10	4.5	4.5	4.5	7	10
Order no.	001 366 706	001 366 709	001 366 717	001 366 707	001 366 711	001 366 215	001 366 216	001 369 408	001 369 401	001 369 403

Hose connectors



Connecting thread	-	-	-	G 1/8"	G 1/4"	G 1/4"	G 3/8"
For hose diameter	4.5	7	10	7	7	10	10
Order no.	001 366 610	001 366 603	001 366 607	001 366 204	001 366 207	001 366 211	001 366 202

Threaded male connectors



Male connections with external threads



Male connections with internal threads



Distributor block with couplings



Connecting thread	G 1/8"	G 1/4"	G 3/8"	G 1/4" i	G 3/8" i	G 3/8" i	G 1/4" i
Order no.	001 367 703	001 367 710	001 367 706	001 367 711	001 367 712	001 367 211	001 367 212

Twin nipples



Reducing nipples



Sealing ring



Connecting thread	G 1/4" x G 1/4"	G 3/8" x G 3/8"	G 1/4" x G 1/8"	G 3/8" x G 1/4"	G 1/2" x G 3/8"	1/8"	1/4"	3/8"
Order no.	001 367 101	001 367 102	001 370 901	001 370 902	001 370 903	001 312 205	001 367 616	001 313 102

01 Straight grinders high speed & oil-free
02 High speed straight grinders
03 Straight grinders
04 Angle grinders
05 Belt sanders
06 Drilling deburrers
07 Pneumatic files
08-11 Brushing tools / chisels / pneumatic saws / drills
12 Accessories



Druckluftwerkzeuge
Pneumatic tools
Outils pneumatiques

Schmid & Wezel GmbH (Maulbronn plant)

Maybachstr. 2
75433 Maulbronn, Germany
Tel. +49 70 43 / 102 - 0
Fax +49 70 43 / 102 - 78
biax-verkauf@biax.de
www.biax-germany.com



Schaber
Scrapers
Grattoirs
Hartmetallwerkzeuge
Carbide tools
Outils en carbure de
tungstène

BIAX Maschinen GmbH

Industrieplatz
8212 Neuhausen/Rheinfall, Switzerland
Tel. +41 52 / 674 79 79
Fax +41 52 / 674 65 64
info@biax.ch
www.biax.ch



Biegsame Wellen
Flexible shafts
Arbres flexibles

Schmid & Wezel GmbH (Hilsbach plant)

Breite Str. 38
74889 Sinsheim-Hilsbach, Germany
Tel. +49 72 60 / 91 33 - 0
Fax +49 72 60 / 91 33 - 25
flexwellen@biax.de
www.biax-flexwellen.de



Fleischereimaschinen
Meat processing machines
Machines pour l'industrie
de la viande

Schmid & Wezel GmbH (Maulbronn plant)

Maybachstr. 2
75433 Maulbronn, Germany
Tel. +49 70 43 / 102 - 0
Fax +49 70 43 / 102 - 78
efa-verkauf@efa-germany.de
www.efa-germany.de



Vertriebsgesellschaft Italien
Distribution company Italy
Société de distribution en Italie

BIAX Italia S.r.l.

Zona Industriale
Via del Garda 46/N
38068 Rovereto (TN), Italy
Tel. +39 464 / 43 31 24
Fax +39 464 / 48 99 52
biaxitalia@biaxitalia.com
www.biaxitalia.com