

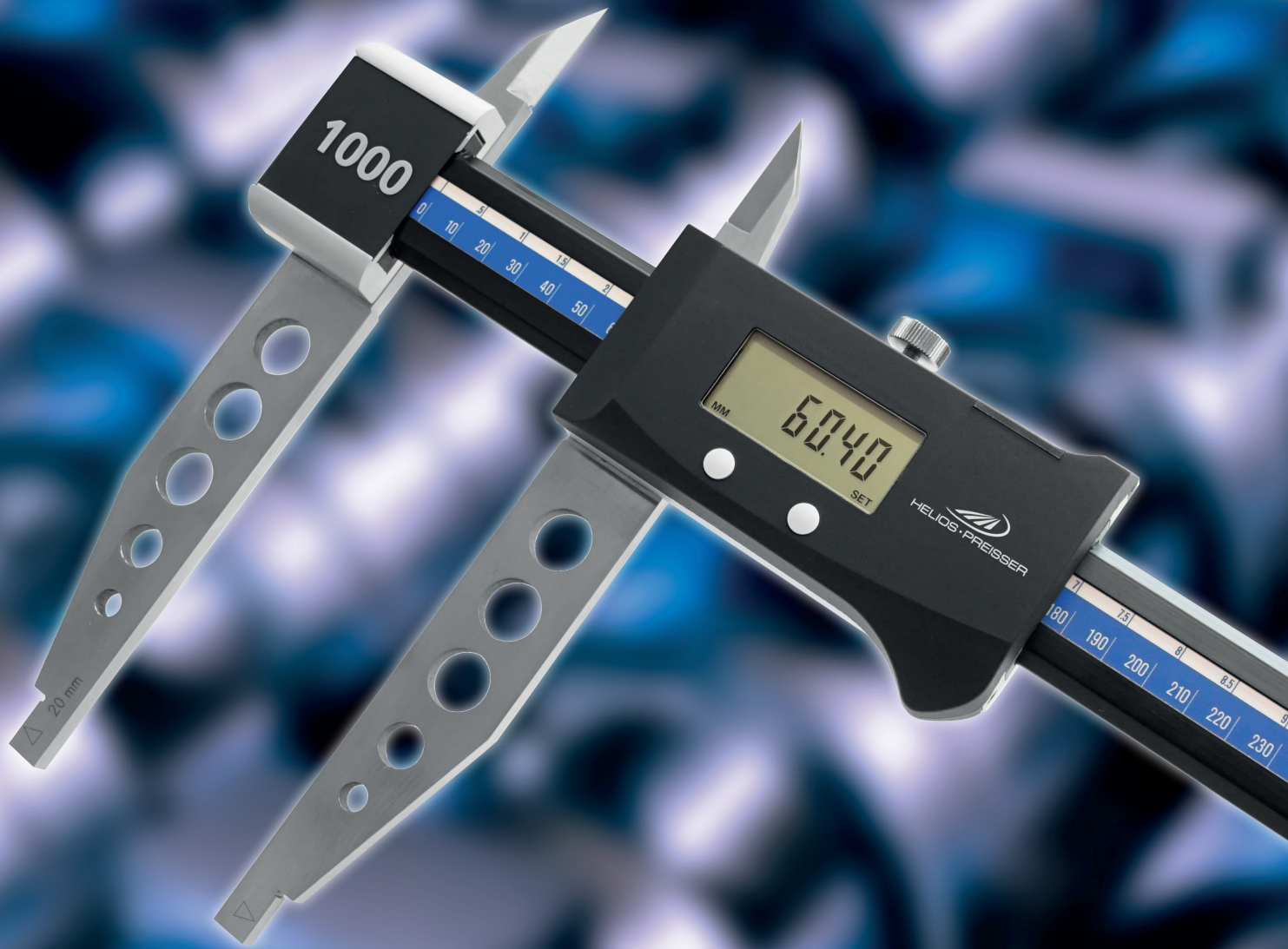

HELIOS · PREISSER

THE TRADE SPECIALISTS



METROLOGY CATALOGUE

In Germany at home – in demand worldwide

www.helios-preisser.de

2021 / 2022

valid from 01.07.2021 to 30.06.2023

METROLOGY CATALOGUE 2021 / 2022



Calipers



Dial gauges and Indicators



Micrometers

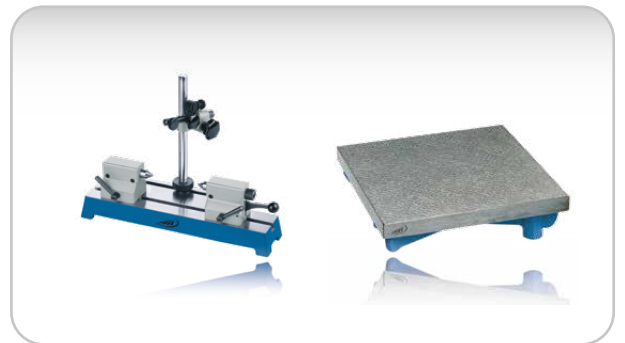

Bench centres and
Inspection plates



Plug gauges and
Feeler gauge tapes

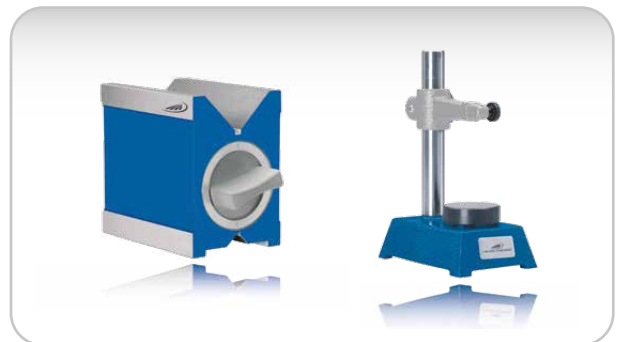

Inspection equipment



Services

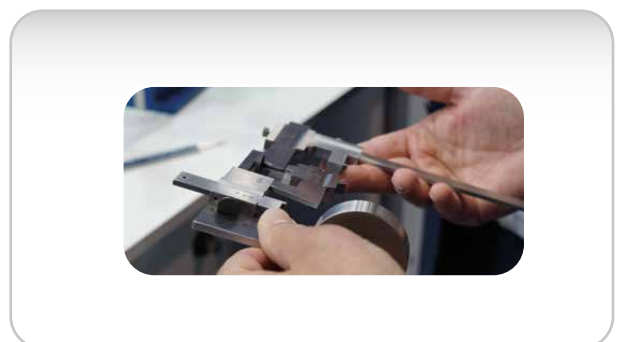

Custom made products

In Germany at home

For more than 80 years



We are certified according to
DIN EN ISO 9001:2015

*„For more than 80 years,
your reliable partner for
everything about metrology“*



HELIOS • PREISSER

Dear customers,

For more than 80 years, HELIOS-PREISSER has been a reliable supplier and partner for metrology of the highest quality and has made a good name for itself as a specialized trade brand among dealers and users far beyond Germany.

In the current catalogue, you will find a large selection of precise measuring and testing equipment to support your daily work and ensure the quality of your production.

In addition, a strong team will support you at HELIOS-PREISSER in Gammertingen or directly on site. No matter if it is about consulting, training, service or sales, we are glad to be there for you.

Challenge us and let us convince you of our capabilities.



Rainer Fahrenholz
Managing director



Services that leave no questions unasked



Precise

You get a completely overhauled product, tested and approved - and immediately ready for use.



Fast

The exchange product will generally leave our company within 24 hours after the arrival of your product.



Reliable

No bad surprises regarding costs. Due to our transparent Repair-Exchange prices, you have full control on your expenses.



Cost-efficient

Your exchange product comes in familiar HELIOS-PREISSER quality and with 6 months of warranty.





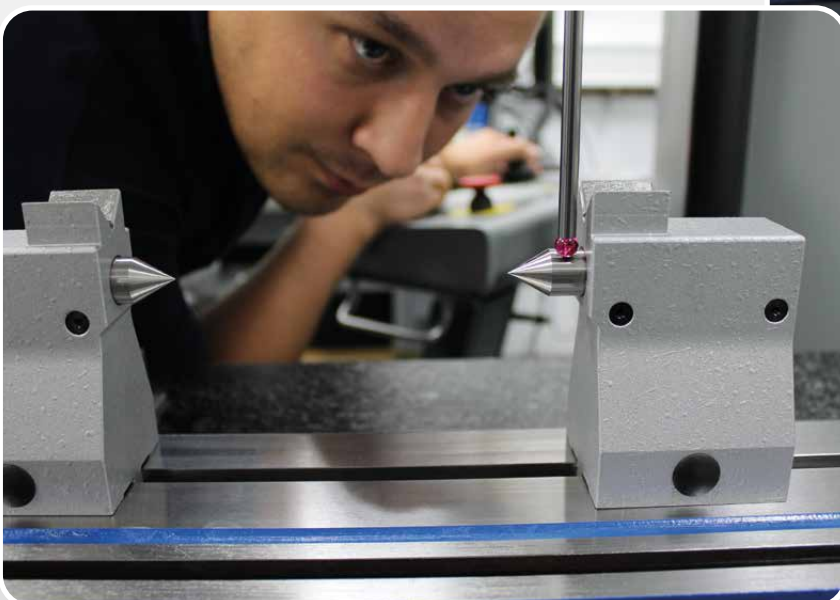
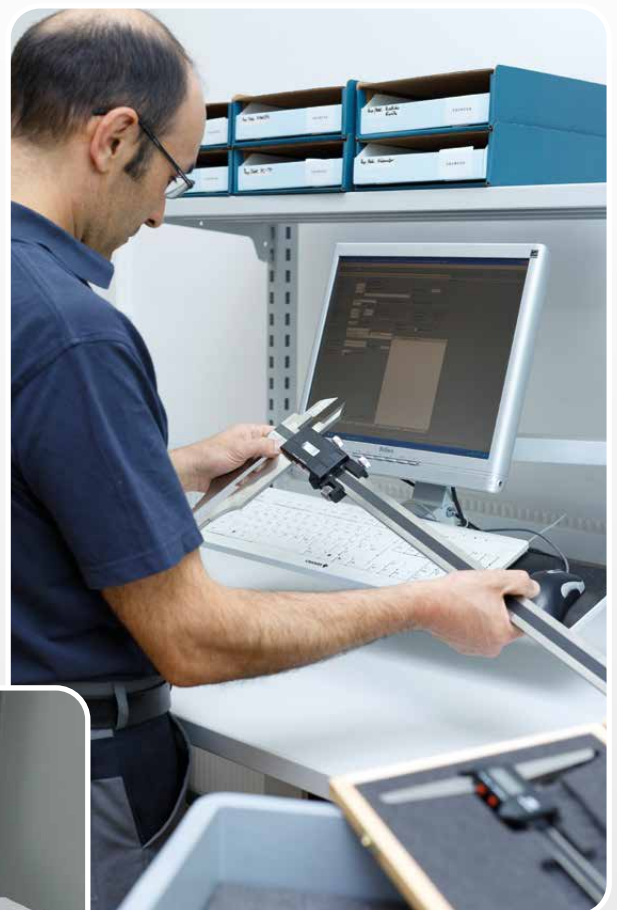

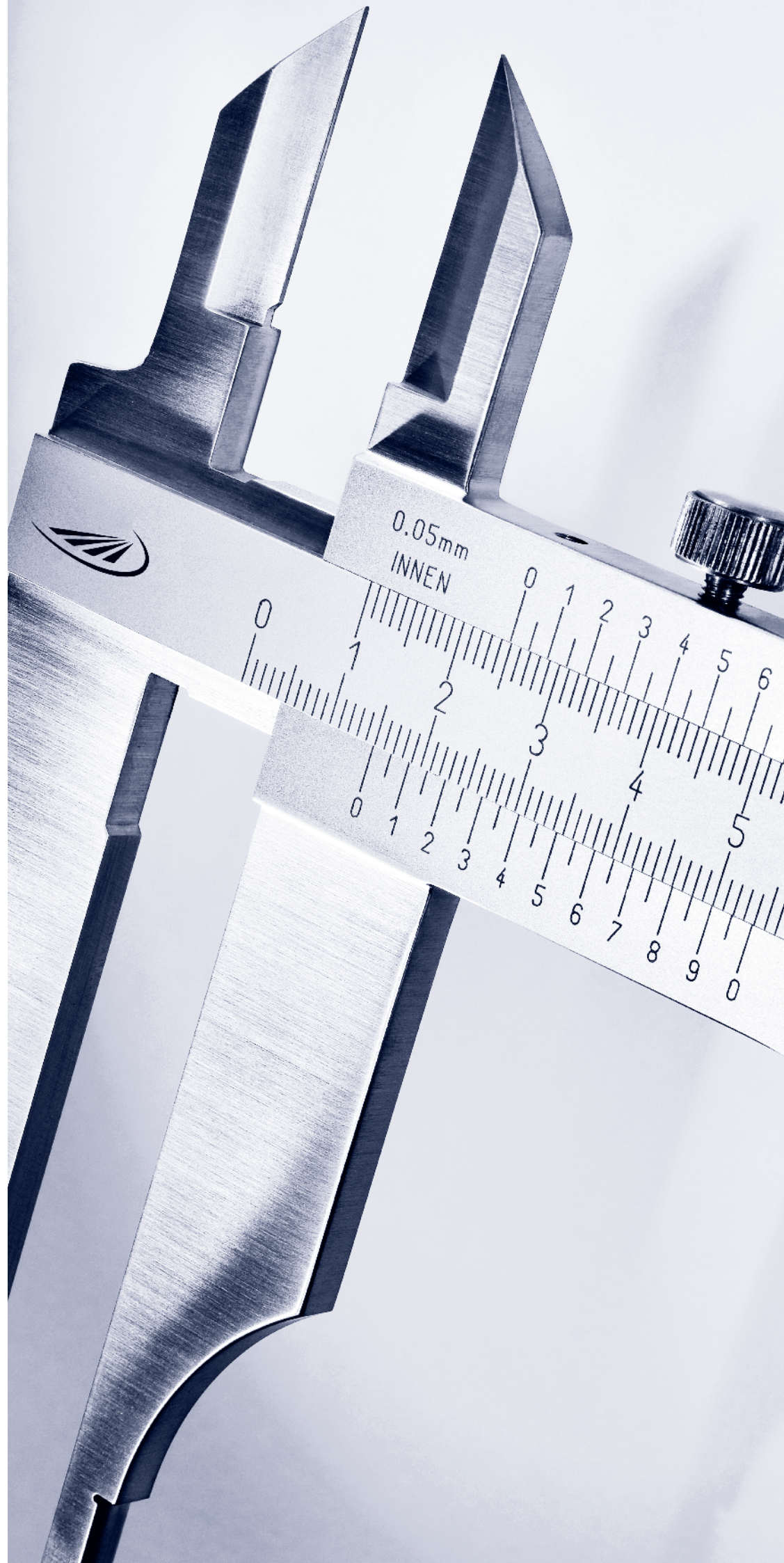

*„Proficient consultation
& first-class service
- we are here for you“*

- Comprehensive technical support**
- Competent after-sales service**
- Professional repairs**
- Calibration and monitoring**





CONTENTS CATALOGUE

1	Calipers	
2	Micrometers	
3	Dial gauges and Indicating instruments	
4	Marking instruments	
5	Squares, Protractors, Bevel protractors	
6	Inspection equipment, Standards, Rules	
7	Data transmission	
8	Calibration service, Order number index, Keyword index	



SAMPLES CALIPER

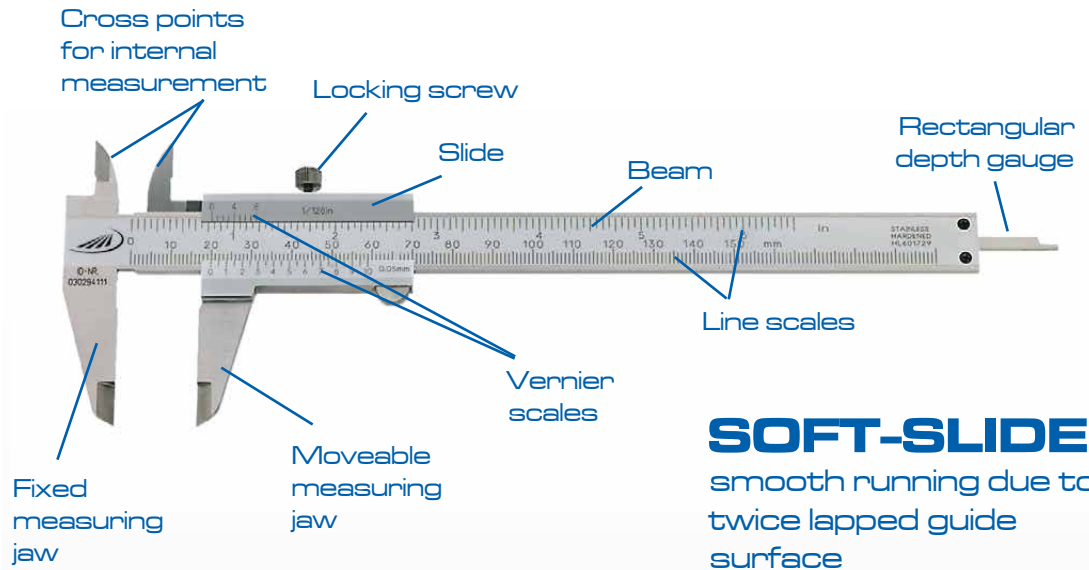

SOFT-SLIDE
smooth running due to twice lapped guide surface

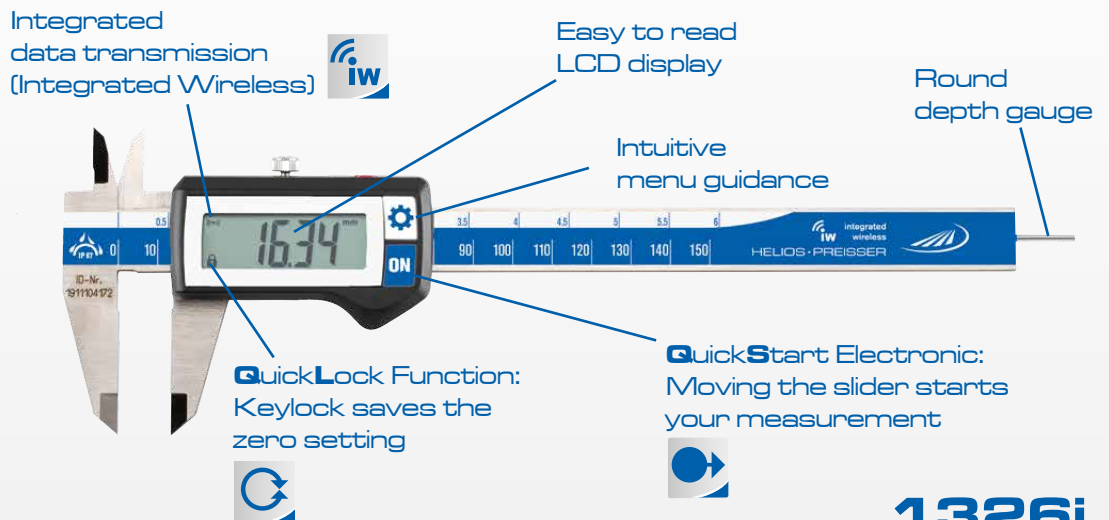

1326i
with integrated wireless

Possible application for **calipers**

External measurement

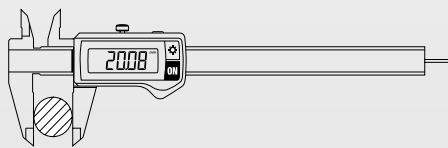

Internal measurement

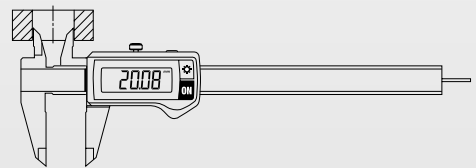

Depth measurement

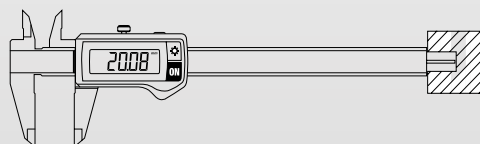

Step (distance) measurement

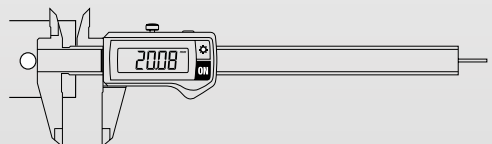

1. CHAPTER CALIPERS

10	Pocket vernier calipers
16	Pocket calipers / Tyre profile depth gauge
17	Pocket calipers with dial
18	Measuring tool sets
20	Digital pocket calipers
24	Universal calipers
26	Digital pocket calipers for specific measuring tasks
32	Vernier workshop calipers
36	Lightweight workshop calipers
37	Analogue caliper with cross points / gripper points
38	Digital workshop calipers
46	Digital lightweight workshop calipers
49	Calipers for external locking grooves
50	Brake drum vernier calipers / Brake disc inspection gauges
51	Calipers for internal locking grooves
52	Calipers for 3/5 point measurement / for milling tool setting
53	Chamfer / Radius gauges
54	Gear tooth calipers
55	Vernier depth gauges
59	Digital depth gauges
67	Digital depth gauges with interchangeable inserts
70	Digital depth gauge for one-handed operation
71	Digital mounting scales
72	Steel gauge block inspection set for calipers
73	Wooden cases for calipers



0184 Pocket vernier calipers



DIN
862



Model

- Stainless steel
- Reading parts have a satin chrome finish
- DIN 862
- Inside cross points
- Low-set master scale
- Four way measurement
- Includes thread table

Delivery

- Imitation leather case

✕	📏	Measuring range		Jaw length		Reading		Error limit	Depth gauge	Order no.	List price
		mm	inch	mm	inch	mm	inch	mm			EUR
With thumb clamp											
		0 - 150	0 - 6	40	1.6	0.05	1/128	0.05	rectangular	0184 501	26.00
		0 - 200	0 - 8	50	1.6	0.05	1/128	0.05	rectangular	0184 505	34.50
		0 - 300	0 - 12	60	2.0	0.05	1/128	0.05	none	0184 508	51.00

0185 Pocket vernier calipers



DIN
862

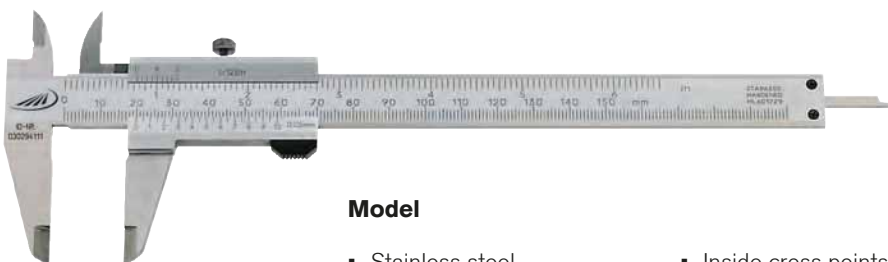

Model

- Stainless steel
- Reading parts have a satin chrome finish
- DIN 862
- Inside cross points
- Low-set master scale
- Four way measurement
- Includes thread table

Delivery

- Imitation leather case

✕	📏	Measuring range		Jaw length		Reading		Error limit	Depth gauge	Order no.	List price
		mm	inch	mm	inch	mm	inch	mm			EUR
With locking screw											
		0 - 100	0 - 4	30	1.2	0.05	-	0.05	rectangular	0185 500	20.00
		0 - 150	0 - 6	40	1.6	0.05	1/128	0.05	rectangular	0185 501	26.00
		0 - 200	0 - 8	50	2.0	0.05	1/128	0.05	rectangular	0185 505	34.50
		0 - 300	0 - 12	60	2.4	0.05	1/128	0.05	none	0185 508	51.00
With reading 0.02 mm											
		0 - 150	0 - 6	40	1.6	0.02	0.001	0.03	rectangular	0185 50105	26.00
		0 - 200	0 - 8	50	2.0	0.02	0.001	0.03	rectangular	0185 50505	34.50



0188 / 0189 Pocket vernier calipers



**DIN
862**

1



Model

- Stainless steel
- Reading parts have a satin chrome finish
- DIN 862
- Inside cross points
- Low-set master scale
- Four way measurement
- Includes thread table

Delivery

- Imitation leather case

Icon	Measuring range		Jaw length		Reading		Error limit	Depth gauge	Order no.	List price
	mm	inch	mm	inch	mm	inch				
With thumb clamp	0 - 150	0 - 6	40	1.6	0.05	1/128	0.05	rectangular	0188 501	23.00
With locking screw	0 - 150	0 - 6	40	1.6	0.05	1/128	0.05	rectangular	0189 501	23.00

0194 / 0195 Pocket vernier calipers with round depth rod



**DIN
862**



Model

- Stainless steel
- Reading parts have a satin chrome finish
- DIN 862
- Inside cross points
- Low-set master scale
- Four way measurement
- Includes thread table

Delivery

- Imitation leather case

Icon	Measuring range		Jaw length		Reading		Error limit	Depth gauge	Order no.	List price
	mm	inch	mm	inch	mm	inch				
With thumb clamp	0 - 150	0 - 6	40	1.6	0.05	1/128	0.05	round 1.6	0194 501	27.00
With locking screw	0 - 150	0 - 6	40	1.6	0.05	1/128	0.05	round 1.6	0195 501	27.00



0196 Pocket vernier calipers with reading 0.02 mm



Model

- Stainless steel
- Reading parts have a satin chrome finish
- DIN 862
- Inside cross points
- Low-set master scale
- Four way measurement
- Includes thread table

Delivery

- Imitation leather case

**DIN
862**

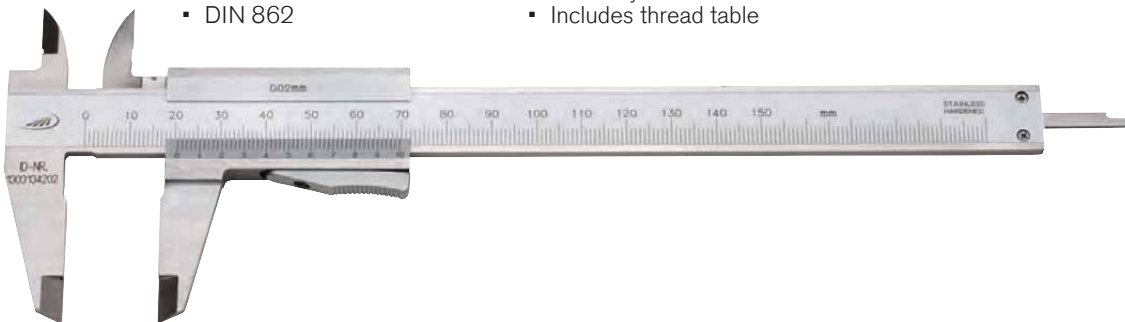

	Measuring range		Jaw length		Reading	Error limit	Depth gauge	Order no.	List price
	mm	inch	mm	inch					
With thumb clamp	0 - 150	0 - 6	40	1.6	0.02	0.03	rectangular	019650 105	25.10

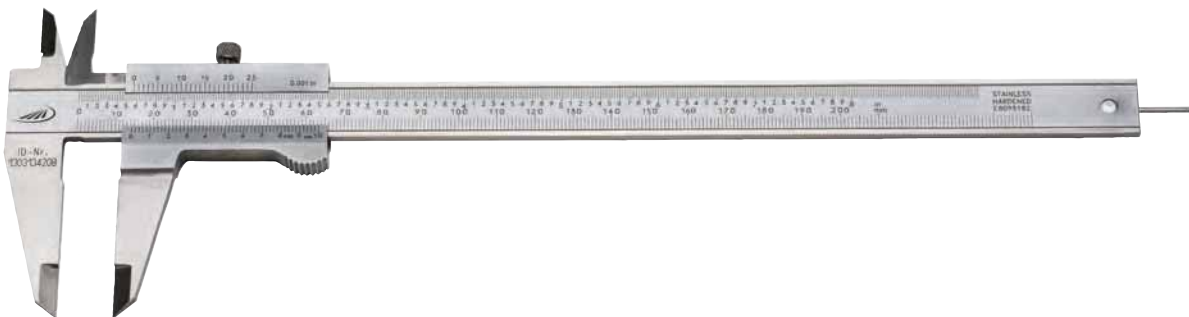

	Measuring range		Jaw length		Reading	Error limit	Depth gauge	Order no.	List price
	mm	inch	mm	inch					
With locking screw	0 - 200	0 - 8	50	2.0	0.02	0.03	round 1.6	019650 516	35.90



	Measuring range		Jaw length		Reading	Error limit	Depth gauge	Order no.	List price
	mm	inch	mm	inch					
With locking screw	0 - 150	0 - 6	40	1.6	0.02	0.03	rectangular	019650 116	25.10



0197 Pocket vernier calipers SOFT - SLIDE



DIN 862

1

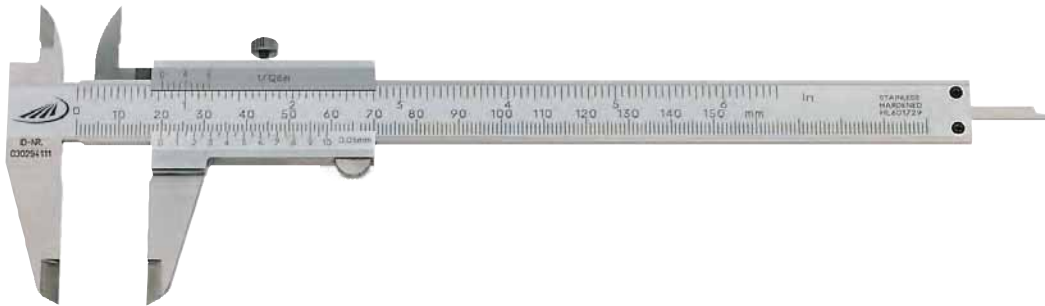

Model

- Smooth running due to twice lapped guide surface
- Stainless steel
- Reading parts have a satin chrome finish

Delivery

- Imitation leather case

Icon	Measuring range		Jaw length		Error limit	Depth gauge	Order no.	List price
	mm	inch	mm	inch				
	0 - 150	0 - 6	40	1.6	0.05	rectangular	0197 501	33.00
	0 - 200	0 - 8	50	2.0	0.05	rectangular	0197 505	75.00
	0 - 300	0 - 12	60	2.4	0.05	none	0197 508	149.00

0198 / 0199 Pocket vernier calipers with parallax-free reading



DIN 862



Model

- **Parallax-free reading**
- Stainless steel
- Reading parts have a satin chrome finish
- DIN 862

Delivery

- Imitation leather case

Icon	Measuring range		Jaw length		Reading		Error limit	Depth gauge	Order no.	List price
	mm	inch	mm	inch	mm	inch				
With thumb clamp										
	0 - 150	0 - 6	40	1.6	0.05	1/128	0.05	rectangular	0198 501	30.50
With locking screw										
	0 - 150	0 - 6	40	1.6	0.05	1/128	0.05	rectangular	0199 501	30.50



0190 Pocket vernier caliper DUO-FIX



DIN
862

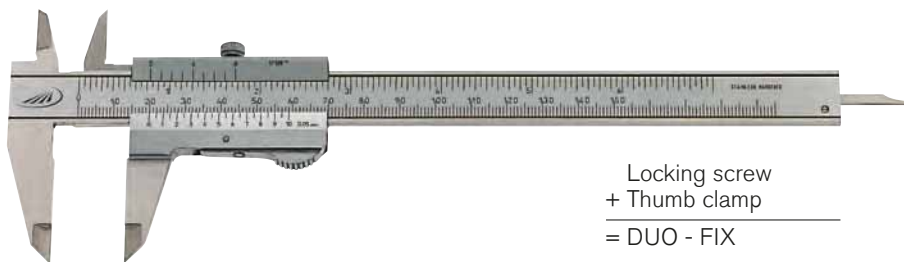

Locking screw
+ Thumb clamp
= DUO - FIX

Model

- Stainless steel
- Reading parts have a satin chrome finish
- DIN 862
- Thumb clamp **and** locking screw
- Inside cross points
- Low-set master scale
- Four way measurement
- Includes thread table

Delivery

- Imitation leather case

✕	📏	Measuring range		Jaw length		Reading		Error limit	Depth gauge	Order no.	List price
		mm	inch	mm	inch	mm	inch	mm			EUR
		0 - 150	0 - 6	40	1.6	0.05	1/128	0.05	rectangular	0190 501	27.00

0203 Precision pocket vernier caliper PRISMA



DIN
862

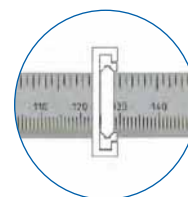

Model

- **Parallax-free reading**
- **Double prisma guide with excellent sliding characteristics**
- Stainless steel
- Reading parts have a satin chrome finish
- DIN 862
- Low-set locking screw
- Inside cross points
- Four way measurement
- Includes thread table

Delivery

- Imitation leather case

✕	📏	Measuring range		Jaw length		Reading		Error limit	Depth gauge	Order no.	List price
		mm	inch	mm	inch	mm	inch	mm			EUR
		0 - 150	0 - 6	40	1.6	0.05	1/128	0.05	rectangular	0203 501	52.00



0182 Pocket vernier caliper for lefthanded

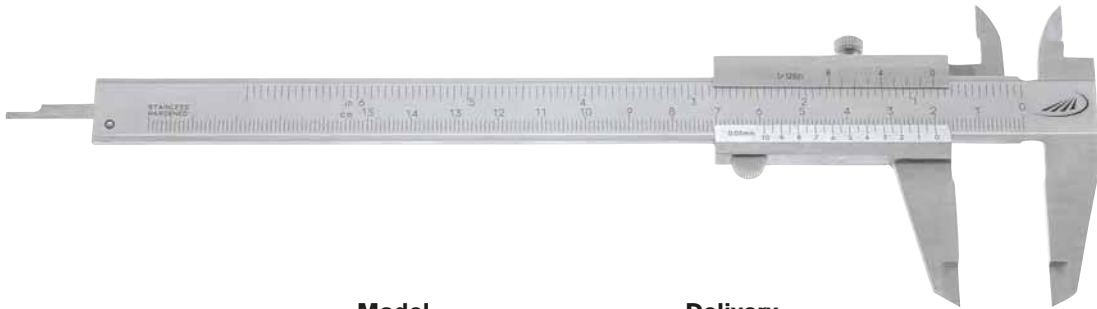



1

Model

- Stainless steel
- Reading parts have a satin chrome finish
- Locking screw
- Factory standard

Delivery

- Imitation leather case

 	Measuring range		Jaw length		Reading		Error limit	Depth gauge	Order no.	List price
	mm	inch	mm	inch	mm	inch	mm			EUR
	0 - 150	0 - 6	40	1.6	0.05	1/128	0.05	rectangular	0182 501	34.50



0180 Pocket caliper



Model

- Made from hard brass
- Factory standard

Delivery

- Cardboard box

	Measuring range		Jaw length		Reading		Order no.	List price
	mm	inch	mm	inch	mm	inch		
	0 - 100	0 - 6	25	1.0	0.1	1/16	0180 320	EUR 7.10

0180 Pocket caliper



Model

- Made from hard brass
- Stepped jaw 5 mm for internal measurement
- Factory standard

Delivery

- Cardboard box

	Measuring range		Jaw length		Reading		Order no.	List price
	mm	inch	mm	inch	mm	inch		
	0 - 100	0 - 6	25	1.0	0.1	1/16	0180 330	EUR 7.10

0180 Tyre profile depth gauge



Model

- Made from hard brass
- Factory standard

Delivery

- Cardboard box

	Measuring range		Jaw length		Reading		Order no.	List price
	mm	inch	mm	inch	mm	inch		
	0 - 30	0 - 1.18	30	1.2	0.1	1/16	0180 310	EUR 4.40



0217 / 0218 Dial calipers



DIN 862

1



Model

- Stainless steel
- Satin chrome scale
- DIN 862
- Locking screw
- Inside cross points

Delivery

- One pointer revolution with 0217 = 2 mm with 0218 = 1 mm
- Four way measurement
- Fitted case

⌘	Measuring range		Jaw length		Reading	Error limit	Depth gauge	Order no.	List price
	mm	inch	mm	inch	mm	mm			EUR
▪	0 - 150	0 - 6	40	1.6	0.02	0.03	rectangular	0217 501	67.00
▪	0 - 200	0 - 8	40	1.6	0.02	0.03	rectangular	0217 502	135.00
▪	0 - 150	0 - 6	40	1.6	0.01	0.03	rectangular	0218 501	90.00



0212 Quality measuring tool set, 8 piece



**INCLUDING
ONE POCKET CALIPER
OF YOUR CHOICE**



0190 501



1320 416



1326 416

Content

- Pocket calipers in 5 different types of choice
- External micrometer with carbide measuring faces, measuring range 0-25 mm, reading 0.01 mm
- Flexible steel rule, stainless steel, measuring range 200 mm, graduation mm / mm, 13 x 0.5 mm
- Knife square, hardened, DIN 875/00, 100 x 70 mm, with non-glare knife edge
- Knife edge, hardened and ground, DIN 874/00, length 100 mm
- Scriber, carbide tipped, hexagonal handle made of one piece, with pocket clip, length 180 mm
- Radius gauge, special steel, 17 sheets, concave and convex, with locking nut, measuring range 1.0 – 7.0 mm
- Screw pitch gauge, combined metric ISO- and Whitworth thread, 48 blades, increments 0.4 – 7.0 / 4 – 62

Shipment

- Wooden case

☒	☒	Measuring range mm	Ablesung mm	Ablesung inch	Tiefenmaß mm	Best. Nr.	Listenpreis EUR
Set mit Taschenmessschieber DUO - FIX (0190 501)							
		0 - 150	0.05	1/128	rect.	0212 520	133.00
Set mit DIGI-MET® Taschenmessschieber (1320 416 / 417)							
		0 - 150	0.01	.0005	rund 1.5	0212 522	195.00
		0 - 150	0.01	.0005	rect.	0212 524	195.00
Set mit DIGI-MET® Taschenmessschieber IP67 (1326 416 / 417)							
		0 - 150	0.01	.0005	rund 1.5	0212 526	219.00
		0 - 150	0.01	.0005	rect.	0212 528	219.00



DIGI-MET® QuickStart Electronic



QuickStart-Electronic with the QuickLock-Function for only one zero setting

All digital calipers with the QuickStart-Electronic also have the **QuickLock** Function. Only set the zero position once, zero position remains stored for all further measurements. When the **QuickLock** Function is activated a lock symbol appears in the display, this ensures that the zero position is protected against any operating error caused by accidental usage of the operating keys (keys are locked). The caliper is immediately ready for measurement; once the caliper is switched ON or the slide is moved, the display is automatically activated.

The need to reset to zero as with a conventional caliper once it is switched on is obsolete.

1

Conventional

- ① Switch ON
- ② Close the measuring jaws
- ③ Set to zero
- ④ Result of measurement

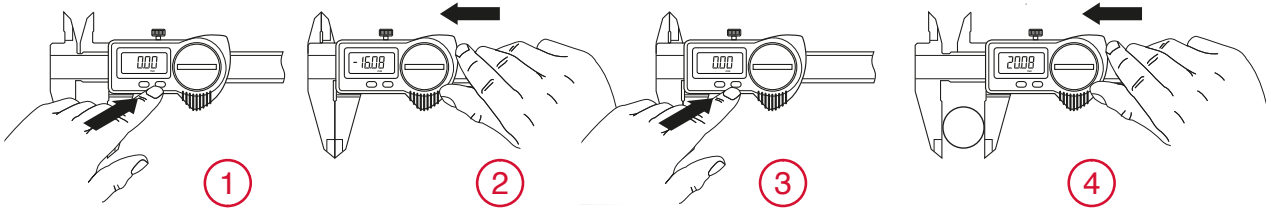

QuickStart Electronic



Press the ON key or move the slide

DIGI-MET® QuickLock-Function



- 1. Set to zero
- 2. Activate the QuickLock Function

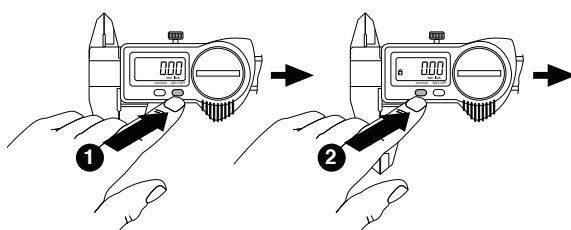

Advantages of the QuickLock Function

- The caliper is immediately ready for measurement
- Lock symbol appears in the display. This ensures that the zero position is protected against any operating error caused by accidental usage of the operating keys (keys are locked)



1326i DIGI-MET® Pocket calipers IP67 with integrated wireless

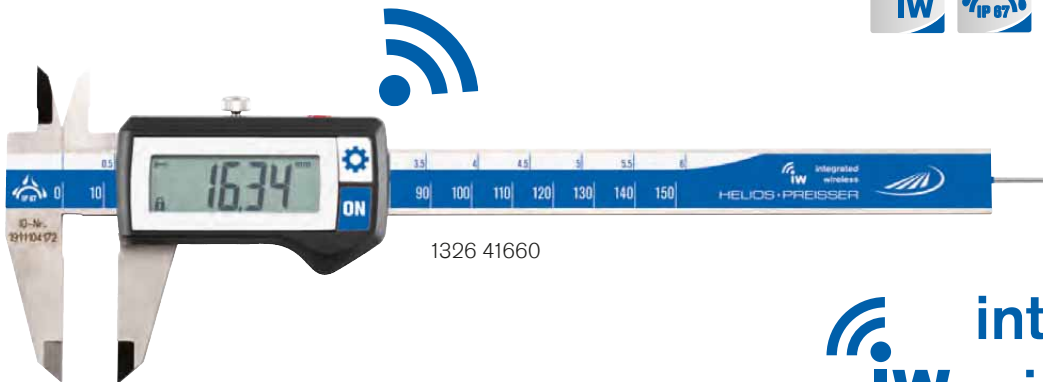

integrated IW wireless

Wireless Data Transmission

Model

- Measuring system is insensitive to cooling agents and dust
- Protection class IP67
- Stainless steel
- LCD display 11 mm
- DIN 862
- Housing and operating keys have an excellent chemical resistance
- Locking screw
- Inside cross points
- Four way measurements

Functions

- ON / OFF
- Quick-Start**
- Quick-Lock** (key lock)
- Set to zero at any point
- mm / inch switching
- PRESET-Function (setting a numerical value)
- Integrated Wireless

Delivery

- Plastic case



More information on our i-series and Integrated Wireless on page 252

✕	📏	Measuring range		Jaw length		Reading		Error limit	Depth gauge	Order no.	List price
		mm	inch	mm	inch	mm	inch	mm			EUR
▪		0 - 150	0 - 6	40	1.6	0.01	.0005	0.03	round 1.5	1326 41660	218.00
▪		0 - 150	0 - 6	40	1.6	0.01	.0005	0.03	rectangular	1326 41760	218.00
▪		0 - 200	0 - 8	50	2.0	0.01	.0005	0.03	rectangular	1326 41860	279.00
▪		0 - 300	0 - 12	65	2.5	0.01	.0005	0.03	none	1326 42260	337.00



1998780

Accessories

Battery, 3V-Lithium, CR 2032

i-Stick USB-receiver for Integrated Wireless

Order no.

0220 704

1998 780

List price

EUR

3.90

95.00

Integrated Wireless is intended to be sold within the European Economic Area only



HELIOS · PREISSER

1320 DIGI-MET® Pocket calipers



1320 416



1320 517



Model

- Inductive measuring system, resistant to moisture and sweat
- Stainless steel
- LCD display 11 mm without data output, 7.5 mm with data output
- DIN 862
- Locking screw
- Inside cross points

- Four way measurement with measuring ranges 150 and 200 mm
- Three way measurement with measuring range 300 mm

Functions

- ON / OFF
- **Quick-Start**
- **Quick-Lock** (key lock)
- Set to zero at any point
- mm / inch switching
- PRESET-Function (setting a numerical value 1320 4xx only)
- Variable data output RS 232 + Digimatic + USB (1320 5xx only)

Delivery

- Plastic case



Video electronic

▶	Measuring range		Jaw length		Reading		Error limit	Depth gauge	Order no.	List price EUR
	mm	inch	mm	inch	mm	inch				
Without data output										
▪	0 - 150	0 - 6	40	1.6	0.01	.0005	0.03	round 1.5	1320 416	115.00
▪	0 - 150	0 - 6	40	1.6	0.01	.0005	0.03	rectangular	1320 417	115.00
With DATA VARIABLE										
▪	0 - 150	0 - 6	40	1.6	0.01	.0005	0.03	round 1.5	1320 516	145.00
▪	0 - 150	0 - 6	40	1.6	0.01	.0005	0.03	rectangular	1320 517	145.00
▪	0 - 200	0 - 8	50	2.0	0.01	.0005	0.03	rectangular	1320 519	185.00
▪	0 - 300	0 - 12	65	2.5	0.01	.0005	0.03	none	1320 522	235.00
With DATA VARIABLE, with extra long cross points (40 mm)										
▪	0 - 150	0 - 6	40	1.6	0.01	.0005	0.03	round 1.5	1320 518	395.00

More information on 1320 518 on page 48



1998720

1998501

1997501

Accessories

	Order no.	List price EUR
Battery, 3V-Lithium, CR 2032	0220 704	3.90
Data cable DATA VARIABLE to digimatic	1998 501	64.00
Data cable DATA VARIABLE to RS232	1997 501	50.00
Data cable DATA VARIABLE to USB	1998 720	72.00



1326 DIGI-MET® Pocket calipers IP67



DIN
862

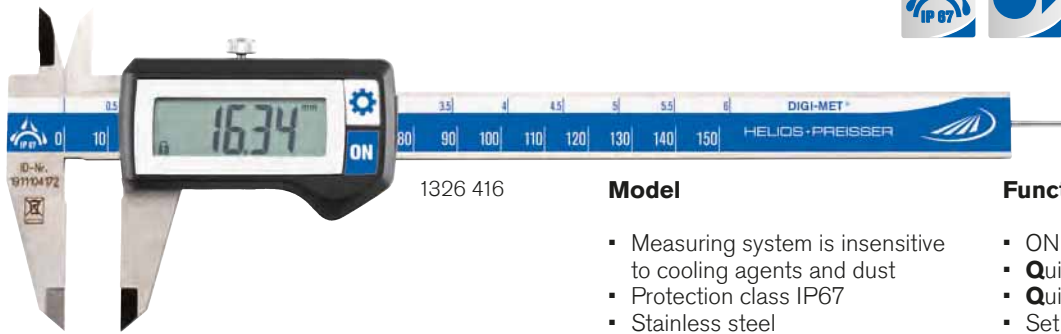

1326 416

Model

- Measuring system is insensitive to cooling agents and dust
- Protection class IP67
- Stainless steel
- LCD display 11 mm
- DIN 862
- Housing and operating keys have an excellent chemical resistance
- Locking screw
- Inside cross points
- Four way measurement with measuring ranges 150 and 200 mm
- Three way measurement with measuring range 300 mm

Functions

- ON / OFF
- Quick-Start**
- Quick-Lock** (key lock)
- Set to zero at any point
- mm / inch switching
- PRESET-Function (setting a numerical value)

Delivery

- Plastic case



Video
electronic

	Measuring range		Jaw length		Reading		Error limit	Depth gauge	Order no.	List price EUR
	mm	inch	mm	inch	mm	inch				
▪	0 - 150	0 - 6	40	1.6	0.01	.0005	0.03	round 1.5	1326 416	159.00
▪	0 - 150	0 - 6	40	1.6	0.01	.0005	0.03	rectangular	1326 417	159.00
▪	0 - 200	0 - 8	50	2.0	0.01	.0005	0.03	rectangular	1326 418	225.00
▪	0 - 300	0 - 12	65	2.5	0.01	.0005	0.03	none	1326 422	285.00

With carbide-tipped measuring jaws

▪	0 - 150	0 - 6	40	1.6	0.01	.0005	0.03	round 1.5	1326 914	343.00
---	---------	-------	----	-----	------	-------	------	-----------	----------	--------

Accessories

	Order no.	List price EUR
Battery, 3V-Lithium, CR 2032	0220 704	3.90

0220 Additional depth measuring base

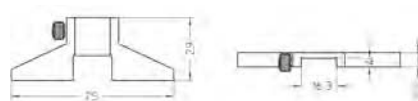

Model

- Stainless steel
- Bridge length: 75 mm
- Dimensions: 75 x 6.5 mm

	Order no.	List price EUR
	0220 705	22.40



HELIOS · PREISSER

1326 DIGI-MET® Pocket calipers IP67 with data output



1

Model

- Measuring system is insensitive to cooling agents and dust
- Protection class IP67
- Stainless steel
- LCD display 7,5 mm
- DIN 862
- Locking screw
- Inside cross points
- Four way measurement

Functions

- ON / OFF
- **Quick-Start**
- **Quick-Lock** (key lock)
- Set to zero at any point
- mm / inch switching
- Variable data output RS 232 + Digimatic + USB

Delivery

- Plastic case

✕	Measuring range		Jaw length		Reading		Error limit	Depth gauge	Order no.	List price
	mm	inch	mm	inch	mm	inch	mm			EUR
▪	0 - 150	0 - 6	40	1.6	0.01	.0005	0.03	round 1.5	1326 516	159.00
▪	0 - 150	0 - 6	40	1.6	0.01	.0005	0.03	rectangular	1326 517	159.00
▪	0 - 200	0 - 8	50	2.0	0.01	.0005	0.03	rectangular	1326 518	235.00



Accessories

	Order no.	List price
		EUR
Battery, 3V-Lithium, CR 2032	0220 704	3.90
Data cable DATA VARIABLE to RS232	1997 501	50.00
Data cable DATA VARIABLE to digimatic	1998 501	64.00
Data cable DATA VARIABLE to USB	1998 720	72.00



1348 DIGI-MET® Universal calipers

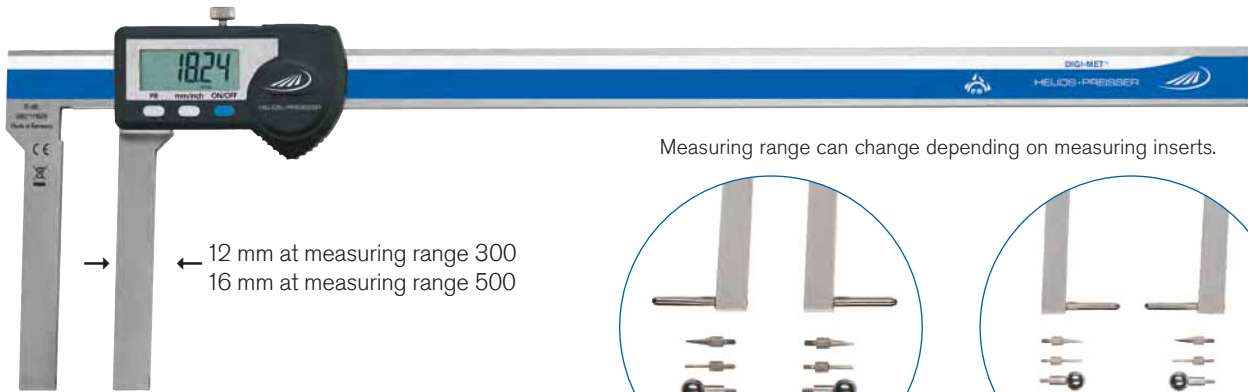

Measuring range can change depending on measuring inserts.

→ ← 12 mm at measuring range 300
16 mm at measuring range 500

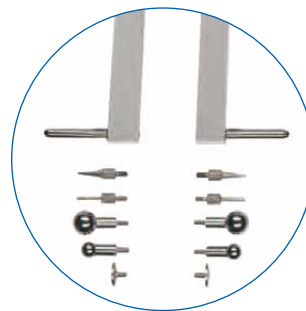

for internal measurements

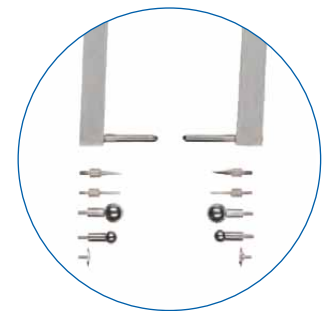

for external measurements

Model

- Stainless steel
- Factory standard
- Protection class IP65
- LCD display 10 or 12.5 mm
- Locking screw
- For internal and external measurements
- Individually adaptable on problematic tasks through measuring inserts with thread M 2.5

Functions

- ON / OFF
- **Quick-Start**
- **Quick-Lock** (key lock)
- Set to zero at any point
- mm / inch switching
- PRESET-Function (setting a numerical value)
- Variable data output RS 232 + Digimatic + USB

Delivery

- Wooden box
- Without measuring inserts
(correct measuring inserts with thread M 2.5 see pages 125 - 128)

✕	Measuring range		Jaw length		Reading		Error limit	Order no.	List price
	mm	inch	mm	inch	mm	inch	mm		EUR
	0 - 300	0 - 12	90	3.5	0.01	.0005	0.06	1348 722	607.00
	0 - 500	0 - 20	100	4.0	0.01	.0005	0.06	1348 728	778.00



1998720

1998501

1997501

Accessories

	Order no.	List price EUR
Battery, 3V-Lithium, CR 2032	0220 704	3.90
Data cable DATA VARIABLE to RS232	1997 501	50.00
Data cable DATA VARIABLE to digimatic	1998 501	64.00
Data cable DATA VARIABLE to USB	1998 720	72.00



HELIOS · PREISSER

1326 Universal pocket caliper „Pocket Talent“



1

Model

- Stainless steel
- Protection class IP67
- Factory standard
- LCD display 7.5 mm
- Locking screw
- For internal and external measurements
- Individually adaptable on problematic tasks through measuring inserts with thread M 2.5

Functions

- ON / OFF
- **Quick-Start**
- **Quick-Lock** (key lock)
- Set to zero at any point
- mm / inch switching
- PRESET-Function (setting a numerical value)
- Variable data output RS 232 + Digimatic + USB

Delivery

- Wooden box
- Measuring inserts No. 0710161* and 0710177*
- Planar surface Ø 4.8 mm / Ball inserts Ø 5.0 mm
- Setting standard

Icon	Measuring range		Jaw length mm	Reading		Order no.	List price EUR
	mm	inch		mm	inch		
	0 - 150	0 - 6	40	0.01	.0005	1326 932	359.00

Our all-round talent can be combined with all common types of measuring inserts for indicators with a standard M 2.5 thread. This way, the Pocket Talent offers you various solutions for numerous measurement applications.

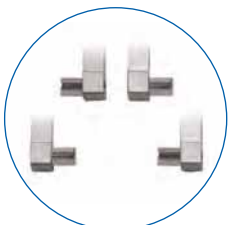

0710161*

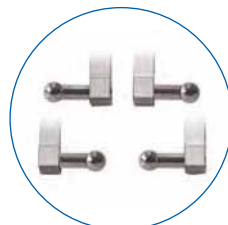

0710177*

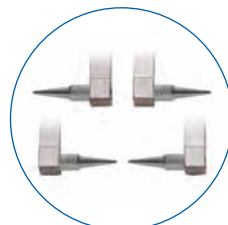

0710166

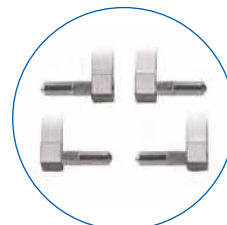

0710167



0710163



1998720



1998501



1997501



Product video

Accessories

Accessories	Order no.	List price EUR
Battery, 3V-Lithium, CR 2032	0220 704	3.90
Measuring inserts M 2.5	0710 161	4.30
Measuring inserts M 2.5	0710 163	6.50
Measuring inserts M 2.5	0710 166	5.90
Measuring inserts M 2.5	0710 167	4.10
Measuring inserts M 2.5	0710 177	8.20
Setting standard for Pocket Talent	1326 990	39.00
Data cable DATA VARIABLE to RS232	1997 501	50.00
Data cable DATA VARIABLE to digimatic	1998 501	64.00
Data cable DATA VARIABLE to USB	1998 720	72.00



1326 DIGI-MET® Pocket calipers for specific measuring tasks

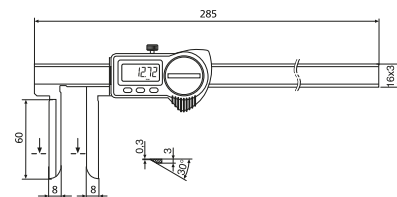
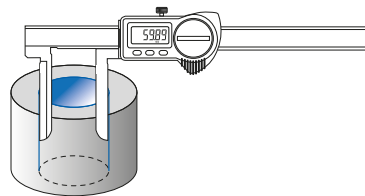
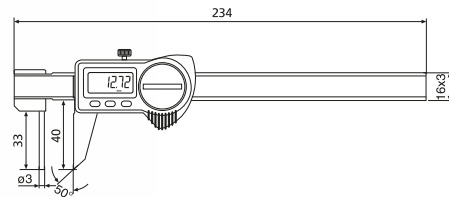
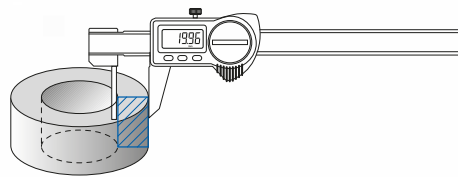
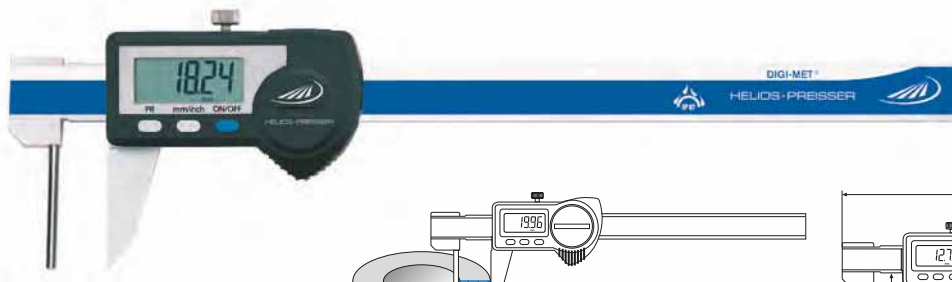

Model

- Protection class IP67
- Stainless steel
- LCD display 7.5 mm
- Factory standard
- Measuring system is insensitive to cooling agents and dust

- Housing and operating keys have an excellent chemical resistance
- Inside cross points
- Locking screw

Functions

- ON / OFF
- Quick-Start
- Quick-Lock (key lock)
- Set to zero at any point
- mm / inch switching
- PRESET-Function (setting a numerical value)
- Variable data output RS 232 + Digimatic + USB

Delivery

- Wooden case

	Measuring range		Jaw length		Reading		Order no.	List price EUR
	mm	inch	mm	inch	mm	inch		
Wall thickness caliper	0 - 150	0 - 6	40	1.6	0.01	.0005	1326 918	503.00
With long cross jaws for inner measurements	10 - 200	0.4 - 8	60	2.4	0.01	.0005	1326 930	653.00

Accessories



1998720 1997501 1998501

Accessories	Order no.	List price EUR
Battery, 3V-Lithium, CR 2032	0220 704	3.90
Data cable DATA VARIABLE to RS232	1997 501	50.00
Data cable DATA VARIABLE to digimatic	1998 501	64.00
Data cable DATA VARIABLE to USB	1998 720	72.00



HELIOS · PREISSER

1326 DIGI-MET® Pocket calipers for specific measuring tasks

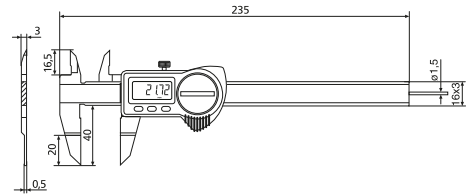
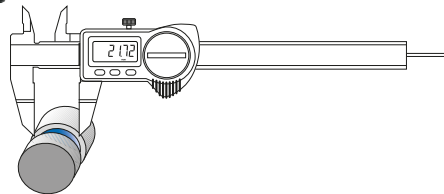
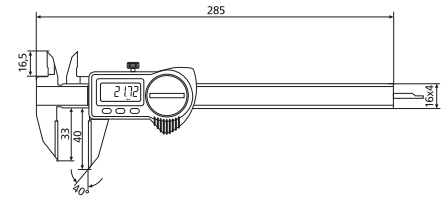
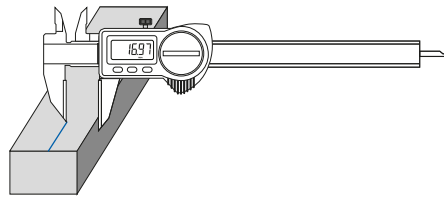
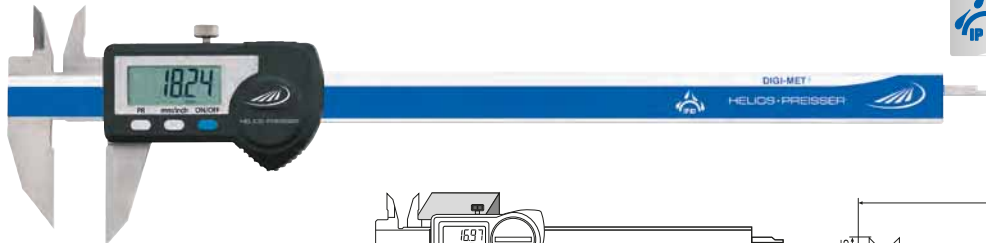

Model

- Protection class IP67
- Stainless steel
- LCD display 7,5 mm
- Factory standard
- Measuring system is insensitive to cooling agents and dust

- Housing and operating keys have an excellent chemical resistance
- Inside cross points
- Locking screw

Functions

- ON / OFF
- Quick-Start
- Quick-Lock (key lock)
- Set to zero at any point
- mm / inch switching
- PRESET-Function (setting a numerical value)
- Variable data output RS 232 + Digimatic + USB

Delivery

- Wooden case

Icon	Measuring range		Jaw length		Reading		Depth gauge	Order no.	List price EUR
	mm	inch	mm	inch	mm	inch			
Scribing caliper with carbide-tipped outer measuring surfaces									
	0 - 200	0 - 8	33	1.3	0.01	.0005	rectangular	1326 912	320.00
With flat measuring surfaces e.g. for outer recesses									
	0 - 150	0 - 6	40	1.6	0.01	.0005	round 1.5	1326 920	545.00

Accessories



1998720 1997501 1998501

	Order no.	List price EUR
Battery, 3V-Lithium, CR 2032	0220 704	3.90
Data cable DATA VARIABLE to RS232	1997 501	50.00
Data cable DATA VARIABLE to digimatic	1998 501	64.00
Data cable DATA VARIABLE to USB	1998 720	72.00



1326 DIGI-MET® Pocket calipers for specific measuring tasks

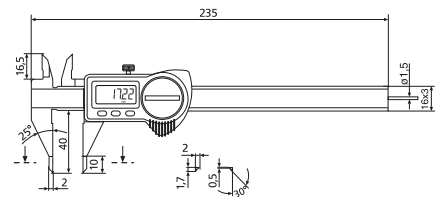
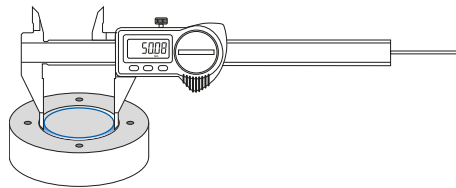
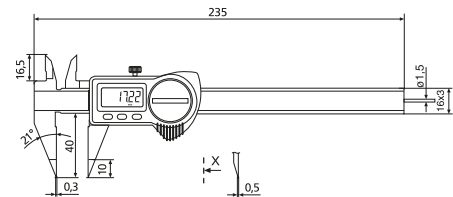
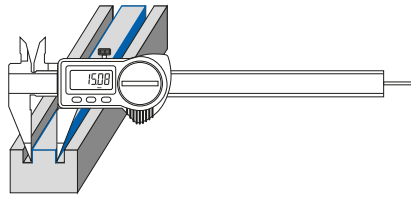

Model

- Protection class IP67
- Stainless steel
- LCD display 7.5 mm
- Factory standard
- Measuring system is insensitive to cooling agents and dust

- Housing and operating keys have an excellent chemical resistance
- Inside cross points
- Locking screw

Functions

- ON / OFF
- Quick-Start
- Quick-Lock (key lock)
- Set to zero at any point
- mm / inch switching
- PRESET-Function (setting a numerical value)
- Variable data output RS 232 + Digimatic + USB

Delivery

- Wooden case

Measuring range	Jaw length		Reading		Order no.	List price EUR
	mm	inch	mm	inch		
With pointed jaws						
0 - 150	0 - 6	40	1.6	0.01	.0005	1326 916 396.00
With fine measuring tips						
0 - 150	0 - 6	40	1.6	0.01	.0005	1326 922 447.00



1998720

1998501

1997501

Accessories

	Order no.	List price EUR
Battery, 3V-Lithium, CR 2032	0220 704	3.90
Data cable DATA VARIABLE to RS232	1997 501	50.00
Data cable DATA VARIABLE to digimatic	1998 501	64.00
Data cable DATA VARIABLE to USB	1998 720	72.00



HELIOS · PREISSER

1326 DIGI-MET® Pocket calipers for specific measuring tasks



1

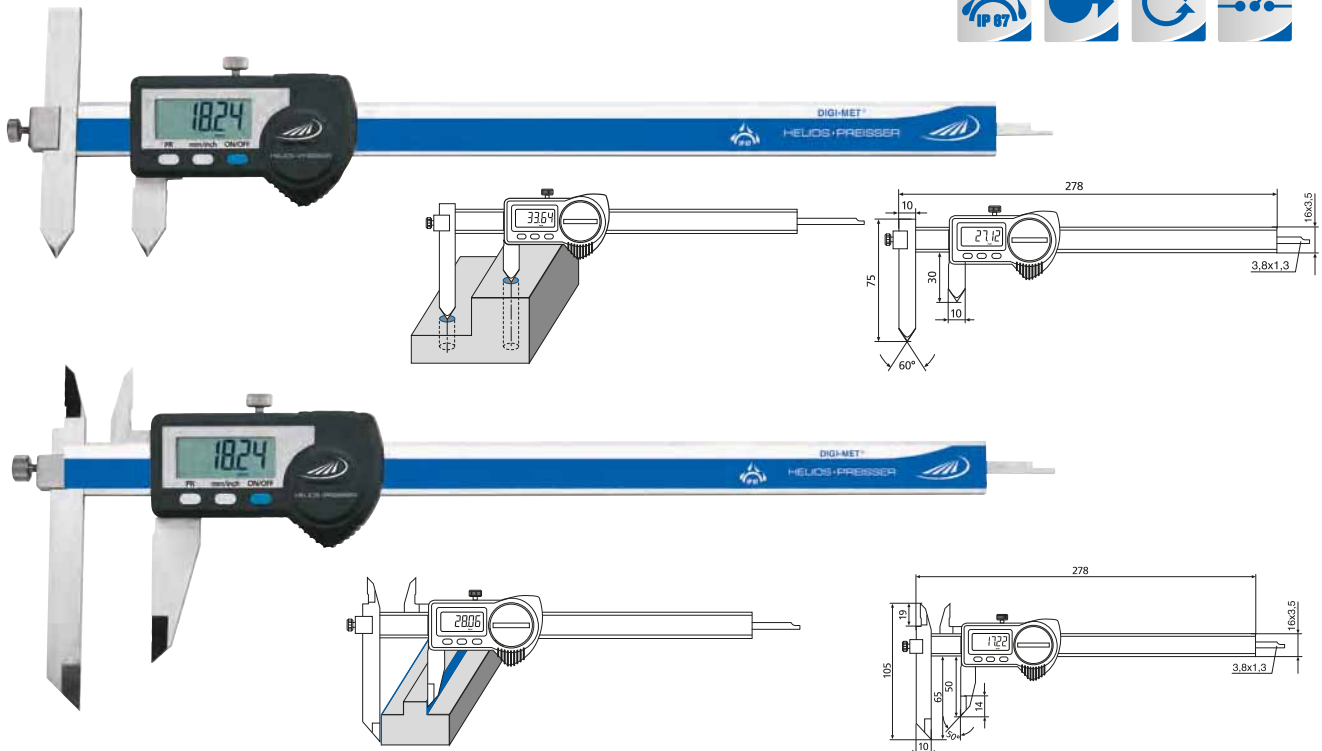

Model

- Protection class IP67
- Stainless steel
- LCD display 7.5 mm
- Factory standard
- Measuring system is insensitive to cooling agents and dust

- Housing and operating keys have an excellent chemical resistance
- Inside cross points
- Locking screw

Functions

- ON / OFF
- Quick-Start**
- Quick-Lock** (key lock)
- Set to zero at any point
- mm / inch switching
- PRESET-Function (setting a numerical value)
- Variable data output RS 232 + Digimatic + USB

Delivery

- Wooden case

Icon	Measuring range		Jaw length		Reading		Order no.	List price EUR
	mm	inch	mm	inch	mm	inch		
Moving jaws for measuring the distance between bores								
	10 - 210	0.4 - 8.3	75	3.0	0.01	.0005	1326 924	443.00
Moving jaws + cross tips								
	0 - 200	0 - 8	65	2.5	0.01	.0005	1326 928	476.00



1998720

1998501

1997501

Accessories

	Order no.	List price EUR
Battery, 3V-Lithium, CR 2032	0220 704	3.90
Data cable DATA VARIABLE to RS232	1997 501	50.00
Data cable DATA VARIABLE to digimatic	1998 501	64.00
Data cable DATA VARIABLE to USB	1998 720	72.00



1326 DIGI-MET® Pocket calipers for specific measuring tasks



Model

- Protection class IP67
- Stainless steel
- LCD display 7.5 mm
- Factory standard
- Measuring system is insensitive to cooling agents and dust
- Housing and operating keys have an excellent chemical resistance
- Inside cross points
- Locking screw

Functions

- ON / OFF
- Quick-Start
- Quick-Lock (key lock)
- Set to zero at any point
- mm / inch switching
- PRESET-Function (setting a numerical value)
- Variable data output RS 232 + Digimatic + USB

Delivery

- Wooden case

Measuring range	Measuring range		Jaw length		Reading		Order no.	List price EUR
	mm	inch	mm	inch	mm	inch		
Measuring tips angled inwards								
0 - 150	0 - 6	40	1.6	0.01	.0005	1326 904	573.00	
Measuring jaws angled inwards								
0 - 150	0 - 6	40	1.6	0.01	.0005	1326 908	489.00	

Accessories



1998720

1997501

1998501

Battery, 3V-Lithium, CR 2032

data cable DATA VARIABLE to RS232

data cable DATA VARIABLE to digimatic

data cable DATA VARIABLE to USB

Order no.

List price
EUR

0220 704

3.90

1997 501

50.00

1998 501

64.00

1998 720

72.00



HELIOS · PREISSER

1326 DIGI-MET® Pocket calipers for specific measuring tasks



Model

- Protection class IP67
- Stainless steel
- LCD display 7.5 mm
- Factory standard
- Measuring system is insensitive to cooling agents and dust

- Housing and operating keys have an excellent chemical resistance
- Inside cross points
- Locking screw

Functions

- ON / OFF
- Quick-Start
- Quick-Lock (key lock)
- Set to zero at any point
- mm / inch switching
- PRESET-Function (setting a numerical value)
- Variable data output RS 232 + Digimatic + USB

Delivery

- Wooden case

Measuring tips angled outwards	Measuring range		Jaw length		Reading		Order no.	List price EUR
	mm	inch	mm	inch	mm	inch		
Measuring tips angled outwards	20.5 - 170	0.8 - 6.7	40	1.6	0.01	.0005	1326 906	568.00
Measuring jaws angled outwards	10.5 - 160	0.4 - 6.3	40	1.6	0.01	.0005	1326 910	562.00

Accessories



	Order no.	List price EUR
Battery, 3V-Lithium, CR 2032	0220 704	3.90
Data cable DATA VARIABLE to RS232	1997 501	50.00
Data cable DATA VARIABLE to digimatic	1998 501	64.00
Data cable DATA VARIABLE to USB	1998 720	72.00



0234 / 0235 Workshop calipers



**DIN
862**



0234 503

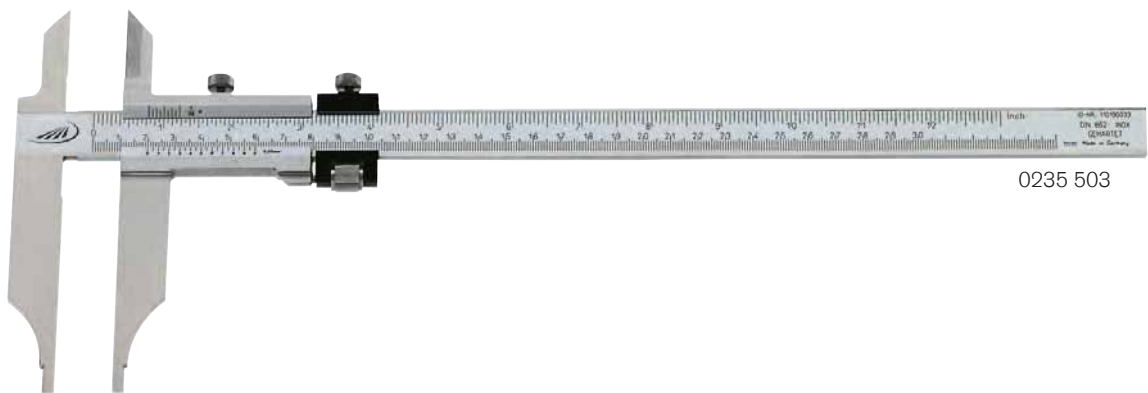

0235 503

Model

- Stainless steel
- Vernier and reading parts have a satin chrome finish
- DIN 862
- Locking screw
- Knife points

Delivery

- Stepped jaws for inside measurement: 10 mm, 20 mm* and 30 mm**
- Low-set master scale
- High-precision laser graduation on vernier and scale
- From 1000 mm measuring range individually packed

✕	📏	Measuring range		Jaw length		Reading		Error limit	Order no.	List price
		mm	inch	mm	inch	mm	inch			
Without fine adjustment										
▪		0 - 300	0 - 12	90	3.5	0.05	1/128	0.05	0234 503	164.00
▪		0 - 500	0 - 20	150	6.0	0.05		0.07	0234 508*	489.00
▪		0 - 800	0 - 31	150	6.0	0.05		0.1	0234 514*	628.00
▪		0 - 1000	0 - 39	150	6.0	0.05		0.12	0234 518*	754.00
	▪	0 - 1500	0 - 59	200	8.0	0.05		0.18	0234 524**	1585.00
	▪	0 - 2000	0 - 79	200	8.0	0.05		0.22	0234 526**	2321.00
With fine adjustment										
▪		0 - 300	0 - 12	90	3.5	0.05	1/128	0.05	0235 503	189.00
▪		0 - 500	0 - 20	150	6.0	0.05		0.07	0235 508*	528.00
▪		0 - 800	0 - 31	150	6.0	0.05		0.1	0235 514*	692.00
▪		0 - 1000	0 - 39	150	6.0	0.05		0.12	0235 518*	817.00
	▪	0 - 1500	0 - 59	200	8.0	0.05		0.18	0235 524**	1681.00
	▪	0 - 2000	0 - 79	200	8.0	0.05		0.22	0235 526**	2476.00



0236 / 0237 Workshop calipers



**DIN
862**

1



Model

- Stainless steel
- Vernier and reading parts have a satin chrome finish
- Factory standard
- Locking screw
- Fine adjustment
- Low-set master scale

- Stepped jaws for inside measurement: 10 mm, 20 mm*, 30 mm** and 50 mm
- High-precision laser graduation on vernier and scale

Delivery

- From 1000 mm measuring range individually packed

Icon	Measuring range		Jaw length		Reading		Error limit	Order no.	List price	
	mm	inch	mm	inch	mm	inch				mm
Without fine adjustment										
▪	0 - 300	0 - 12	90	3.5	0.05	1/128	0.05	0236 503	146.00	
▪	0 - 500	0 - 20	150	6.0	0.05		0.07	0236 508*	407.00	
▪	0 - 800	0 - 31	150	6.0	0.05		0.1	0236 514*	504.00	
▪	0 - 1000	0 - 39	150	6.0	0.05		0.12	0236 518**	629.00	
▪	0 - 1500	0 - 59	200	8.0	0.05		0.18	0236 524**	1387.00	
▪	0 - 2000	0 - 79	200	8.0	0.05		0.22	0236 526	2090.00	
With fine adjustment										
▪	0 - 300	0 - 12	90	3.5	0.05	1/128	0.05	0237 503	174.00	
▪	0 - 500	0 - 20	150	6.0	0.05		0.07	0237 508*	457.00	
▪	0 - 800	0 - 31	150	6.0	0.05		0.1	0237 514*	567.00	
▪	0 - 1000	0 - 39	150	6.0	0.05		0.12	0237 518*	693.00	
▪	0 - 1500	0 - 59	200	8.0	0.05		0.18	0237 524**	1484.00	
▪	0 - 2000	0 - 79	200	8.0	0.05		0.22	0237 526**	2249.00	



0236 / 0237 Workshop calipers with long measuring jaws



Model

- Stainless steel
- Vernier and reading parts have a satin chrome finish
- Factory standard
- Locking screw
- Low-set master scale
- Stepped jaws for inside measurement: 10 mm, 20 mm*, 30 mm** and 50 mm
- High-precision laser graduation on vernier and scale

Delivery

- Cardboard box up to measuring range 1000 mm, larger measuring ranges are individually packed

		Measuring range		Jaw length		Reading		Error limit mm	Order no.	List price EUR
		mm	inch	mm	inch	mm	inch			
Without fine adjustment										
		0 - 300	12	150	6.0	0.05	1/128	0.1	0236 504	258.00
		0 - 500	20	200	8.0	0.05		0.14	0236 509*	536.00
		0 - 500	20	250	10.0	0.05		0.14	0236 510*	640.00
		0 - 800	31	200	8.0	0.05		0.2	0236 515*	779.00
		0 - 800	31	300	12.0	0.05		0.2	0236 516*	994.00
		0 - 800	31	400	16.0	0.05		0.2	0236 517**	1166.00
		0 - 1000	39	200	8.0	0.05		0.24	0236 519*	956.00
		0 - 1000	39	300	12.0	0.05		0.24	0236 520*	1206.00
		0 - 1000	39	500	20.0	0.05		0.24	0236 521**	1647.00
	▪	0 - 1500	59	300	12.0	0.05		0.36	0236 525**	1692.00
	▪	0 - 2000	79	300	12.0	0.05		0.44	0236 527**	2506.00
With fine adjustment										
		0 - 300	0 - 12	150	6.0	0.05	1/128	0.1	0237 504	283.00
		0 - 400	0 - 16	200	8.0	0.05		0.12	0237 507*	534.00
		0 - 500	0 - 20	200	8.0	0.05		0.14	0237 509*	586.00
		0 - 500	0 - 20	250	10.0	0.05		0.14	0237 510*	691.00
		0 - 800	0 - 31	200	8.0	0.05		0.2	0237 515*	843.00
		0 - 800	0 - 31	300	12.0	0.05		0.2	0237 516*	1055.00
		0 - 800	0 - 31	400	16.0	0.05		0.2	0237 517**	1231.00
		0 - 1000	0 - 39	200	8.0	0.05		0.24	0237 519*	1016.00
		0 - 1000	0 - 39	300	12.0	0.05		0.24	0237 520*	1269.00
		0 - 1000	0 - 39	500	20.0	0.05		0.24	0237 521**	1713.00
	▪	0 - 1500	0 - 59	300	12.0	0.05		0.36	0237 525**	1792.00
	▪	0 - 2000	0 - 79	300	12.0	0.05		0.44	0237 527**	2663.00



0230 / 0231 Workshop calipers with parallax-free reading



DIN 862

1

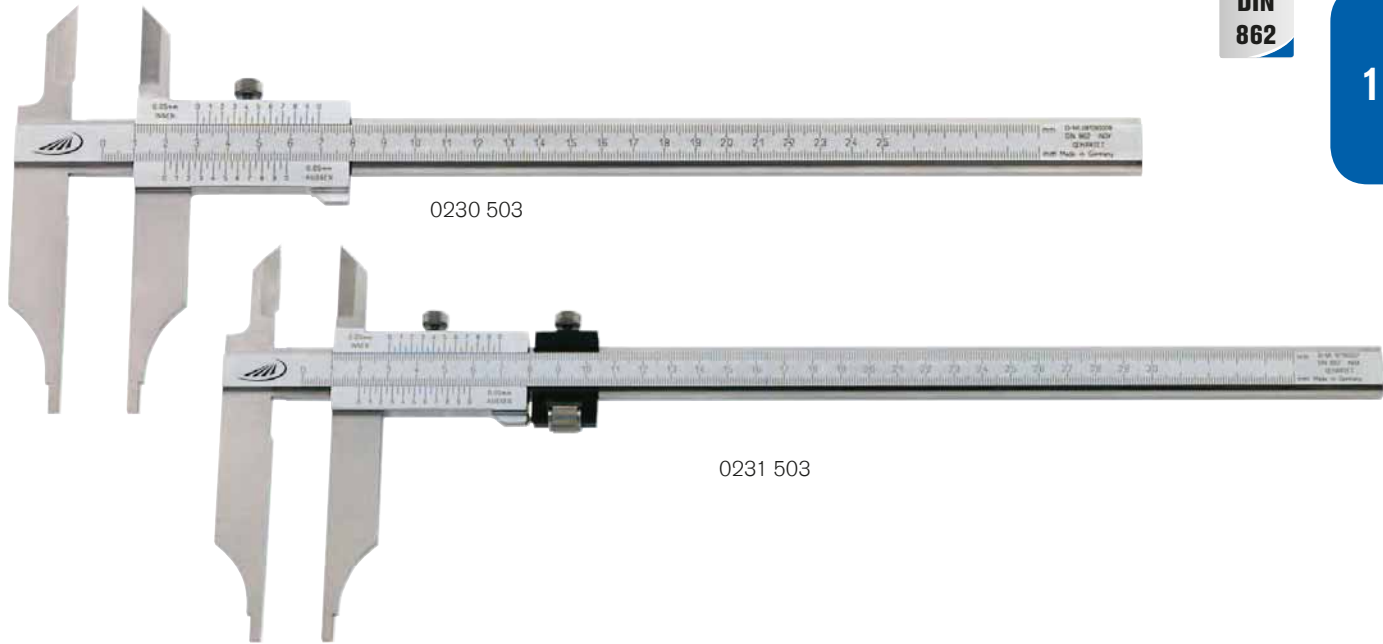

Model

- Parallax-free reading
- Stainless steel
- Reading parts have a satin chrome finish
- DIN 862
- Locking screw
- Knife points

Delivery

- Stepped jaws for inside measurement: 10 mm, for measuring range 500 mm: 20 mm
- Direct reading of internal and external measurements
- High-precision laser graduation on vernier and scale
- Cardboard box

Icon	Measuring range		Jaw length		Reading	Error limit	Order no.	List price
	mm	inch	mm	inch				
Without fine adjustment								
▪	0 - 300	0 - 12	90	3.5	0.05	0.05	0230 503	178.00
▪	0 - 500	0 - 20	150	6.0	0.05	0.07	0230 508	510.00
With fine adjustment								
▪	0 - 300	0 - 12	90	3.5	0.05	0.05	0231 503	205.00
▪	0 - 500	0 - 20	150	6.0	0.05	0.07	0231 508	557.00



0238 Lightweight workshop calipers



Model

- To reduce weight, both, slide and beam, are made of aluminium, with a hard anodized surface coating (1100 HV)
- Measuring faces are made of hardened stainless steel
- Factory standard
- Parallax-free reading
- Smooth running due to double V-guide
- Locking screw
- Knife points
- Stepped jaws for inside measurement 20 mm

Delivery

- Wooden case for calipers up to 1000 mm, larger measuring ranges are packed into cardboard boxes

✕	🏠	Measuring range	Jaw length	Reading	Error limit	Order no.	List price
		mm	mm	mm	mm		EUR
		0 - 300	90	0.02	0.05	0238 503	379.00
		0 - 500	150	0.02	0.07	0238 508	542.00
		0 - 800	150	0.02	0.1	0238 514	724.00
		0 - 1000	150	0.02	0.12	0238 518	848.00
	▪	0 - 1500	200	0.05	0.17	0238 524	2199.00
	▪	0 - 2000	200	0.05	0.22	0238 526	2560.00



0265 Caliper with cross points



1

Model

- Stainless steel
- Reading parts have a satin chrome finish
- Factory standard
- Locking screw
- Inside cross points length 55 mm

Delivery

- Wooden case

Icon	Measuring range	Jaw length		Reading	Error limit	Order no.	List price
	mm	mm	inch	mm	mm		EUR
	0 - 250	80	3.1	0.02	0.03	0265 52005	270.00

0266 Caliper with gripper points

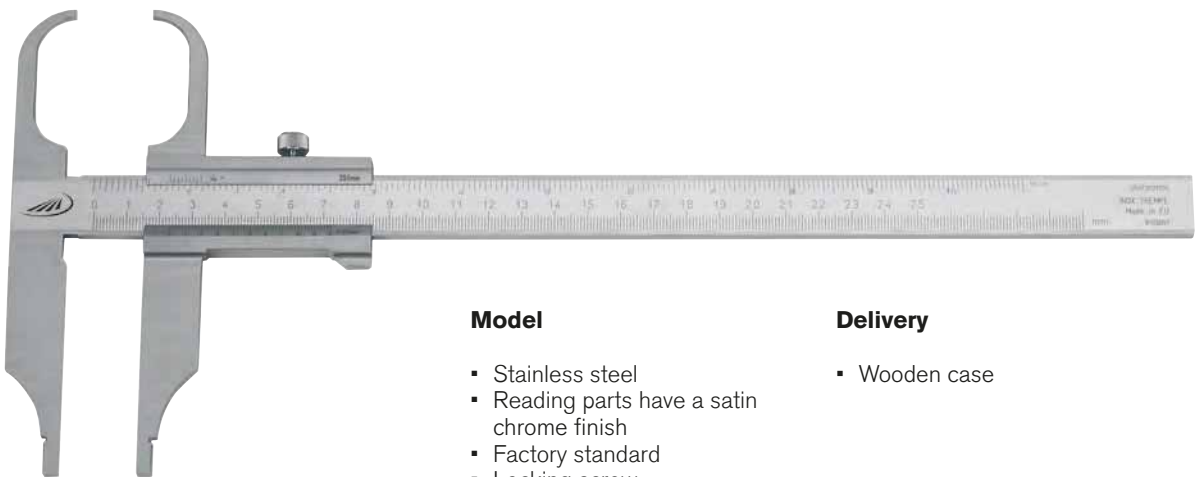

Model

- Stainless steel
- Reading parts have a satin chrome finish
- Factory standard
- Locking screw
- Gripper points length 55 mm

Delivery

- Wooden case

Icon	Measuring range	Jaw length		Reading	Error limit	Order no.	List price
	mm	mm	inch	mm	mm		EUR
	0 - 250	75	3.0	0.02	0.03	0266 52005	362.00



1330 / 1331 DIGI-MET® Workshop calipers

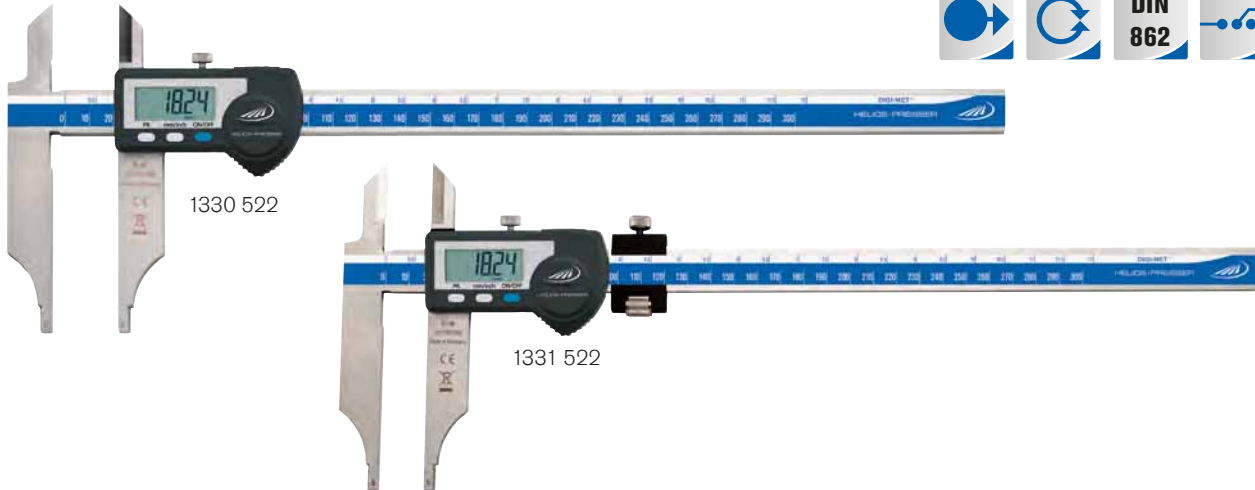

Model

- Stainless steel
- Inductive measuring system, resistant to damp and sweat
- DIN 862
- Knife points
- LCD display:
 - 10 mm with measuring range 300 mm;
 - 12.5 mm from measuring range 500 mm
- Locking screw

Functions

- ON / OFF
- **Quick-Start**
- **Quick-Lock** (key lock)
- Set to zero at any point
- mm / inch switching
- PRESET-Function (setting a numerical value)
- Variable data output RS 232 + Digimatic + USB

Delivery

- Wooden case

☒	🇺🇸	Measuring range		Jaw length		Reading		Stepped jaws mm	Error limit mm	Order no.	List price EUR
		mm	inch	mm	inch	mm	inch				
With knife points, without fine adjustment											
▪		0 - 300	0 - 12	90	3.5	0.01	.0005	10	0.03	1330 522	398.00
▪		0 - 500	0 - 20	125	5.0	0.01	.0005	20	0.03	1330 528	607.00
▪		0 - 800	0 - 31	150	6.0	0.01	.0005	20	0.04	1330 532	992.00
▪		0 - 1000	0 - 39	150	6.0	0.01	.0005	20	0.04	1330 534	1200.00
With knife points, with fine adjustment											
▪		0 - 300	0 - 12	90	3.5	0.01	.0005	10	0.03	1331 522	462.00
▪		0 - 500	0 - 20	125	5.0	0.01	.0005	20	0.03	1331 528	681.00
▪		0 - 800	0 - 31	150	6.0	0.01	.0005	20	0.04	1331 532	1049.00
▪		0 - 1000	0 - 39	150	6.0	0.01	.0005	20	0.04	1331 534	1206.00

Accessories



1998720

1997501

1998501

Battery, 3V-Lithium, CR 2032

Data cable DATA VARIABLE to USB

Data cable DATA VARIABLE to RS232

Data cable DATA VARIABLE to Digimatic

Order no.

0220 704

1998 720

1997 501

1998 501

List price
EUR

3.90

72.00

50.00

64.00



1334 / 1335 DIGI-MET® Workshop calipers



1334 522

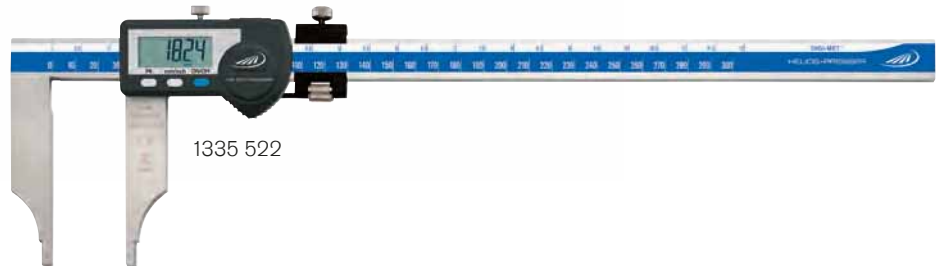

1335 522

1

Model

- Stainless steel
- Inductive measuring system, resistant to damp and sweat
- DIN 862
- LCD display:
 - 10 mm with measuring range 300 mm;
 - 12.5 mm from measuring range 500 mm
- Locking screw

Functions

- ON / OFF
- **Quick-Start**
- **Quick-Lock** (key lock)
- Set to zero at any point
- mm / inch switching
- PRESET-Function (setting a numerical value)
- Variable data output RS 232 + Digimatic + USB

Delivery

- Wooden case

Icon	Measuring range		Jaw length		Reading		Stepped jaws	Error limit	Order no.	List price
	mm	inch	mm	inch	mm	inch				
Without fine adjustment										
▪	0 - 300	0 - 12	90	3.5	0.01	.0005	10	0.03	1334 522	369.00
▪	0 - 500	0 - 20	125	5.0	0.01	.0005	20	0.03	1334 528	518.00
▪	0 - 800	0 - 31	150	6.0	0.01	.0005	20	0.04	1334 532	905.00
▪	0 - 1000	0 - 39	150	6.0	0.01	.0005	20	0.04	1334 534	1071.00
With fine adjustment										
▪	0 - 300	0 - 12	90	3.5	0.01	.0005	10	0.03	1335 522	422.00
▪	0 - 500	0 - 20	125	5.0	0.01	.0005	20	0.03	1335 528	596.00
▪	0 - 800	0 - 31	150	6.0	0.01	.0005	20	0.04	1335 532	973.00
▪	0 - 1000	0 - 39	150	6.0	0.01	.0005	20	0.04	1335 534	1118.00



1998720

1997501

1998501

Accessories

	Order no.	List price
Battery, 3V-Lithium, CR 2032	0220 704	3.90
Data cable DATA VARIABLE to USB	1998 720	72.00
Data cable DATA VARIABLE to RS232	1997 501	50.00
Data cable DATA VARIABLE to Digimatic	1998 501	64.00



1340 / 1341 DIGI-MET® Workshop calipers IP65



1340 522



1341 522

Model

- Stainless steel
- Inductive measuring system, protection class IP65
- DIN 862
- Knife points
- LCD display:
 - 10 mm with measuring range 300 mm;
 - 12.5 mm from measuring range 500 mm
- Locking screw

Functions

- ON / OFF
- **Quick-Start**
- **Quick-Lock** (key lock)
- Set to zero at any point
- mm / inch switching
- PRESET-Function (setting a numerical value)
- Variable data output RS 232 + Digimatic + USB

Delivery

- Wooden case

Marked	Measuring range	Jaw length		Reading		Stepped jaws	Error limit	Order no.	List price	
		mm	inch	mm	inch					mm
With knife points, without fine adjustment										
▪	0 - 300	0 - 12	90	3.5	0.01	.0005	10	0.03	1340 522	431.00
▪	0 - 500	0 - 20	125	5.0	0.01	.0005	20	0.03	1340 528	822.00
▪	0 - 800	0 - 31	150	6.0	0.01	.0005	20	0.04	1340 532	1110.00
▪	0 - 1000	0 - 39	150	6.0	0.01	.0005	20	0.04	1340 534	1365.00
With knife points, with fine adjustment										
▪	0 - 300	0 - 12	90	3.5	0.01	.0005	10	0.03	1341 522	488.00
▪	0 - 500	0 - 20	125	5.0	0.01	.0005	20	0.03	1341 528	878.00
▪	0 - 800	0 - 31	150	6.0	0.01	.0005	20	0.04	1341 532	1165.00
▪	0 - 1000	0 - 39	150	6.0	0.01	.0005	20	0.04	1341 534	1420.00



1998720

1997501

1998501

Accessories

- Battery, 3V-Lithium, CR 2032
- Data cable DATA VARIABLE to USB
- Data cable DATA VARIABLE to RS232
- Data cable DATA VARIABLE to digimatic

Order no.

List price

EUR

0220 704

3.90

1998 720

72.00

1997 501

50.00

1998 501

64.00



HELIOS · PREISSER

1342 / 1343 DIGI-MET® Workshop calipers IP65



1



Model

- Stainless steel
- Inductive measuring system, protection class IP65
- DIN 862
- LCD display:
 - 10 mm with measuring range 300 mm;
 - 12.5 mm from measuring range 500 mm
- Locking screw

Functions

- ON / OFF
- **Quick-Start**
- **Quick-Lock** (key lock)
- Set to zero at any point
- mm / inch switching
- PRESET-Function (setting a numerical value)
- Variable data output RS 232 + Digimatic + USB

Delivery

- Wooden case

Icon	Measuring range		Jaw length		Reading		Stepped jaws	Error limit	Order no.	List price
	mm	inch	mm	inch	mm	inch				
Without fine adjustment										
▪	0 - 300	0 - 12	90	3.5	0.01	.0005	10	0.03	1342 522	396.00
▪	0 - 500	0 - 20	125	5.0	0.01	.0005	20	0.03	1342 528	731.00
▪	0 - 800	0 - 31	150	6.0	0.01	.0005	20	0.04	1342 532	1012.00
▪	0 - 1000	0 - 39	150	6.0	0.01	.0005	20	0.04	1342 534	1259.00
With fine adjustment										
▪	0 - 300	0 - 12	90	3.5	0.01	.0005	10	0.03	1343 522	452.00
▪	0 - 500	0 - 20	125	5.0	0.01	.0005	20	0.03	1343 528	788.00
▪	0 - 800	0 - 31	150	6.0	0.01	.0005	20	0.04	1343 532	1068.00
▪	0 - 1000	0 - 39	150	6.0	0.01	.0005	20	0.04	1343 534	1314.00



Accessories

	Order no.	List price
		EUR
Battery, 3V-Lithium, CR 2032	0220 704	3.90
Data cable DATA VARIABLE to USB	1998 720	72.00
Data cable DATA VARIABLE to RS232	1997 501	50.00
Data cable DATA VARIABLE to digimatic	1998 501	64.00



0222 / 0223 DIGI-MET® Workshop calipers long version



0222 736

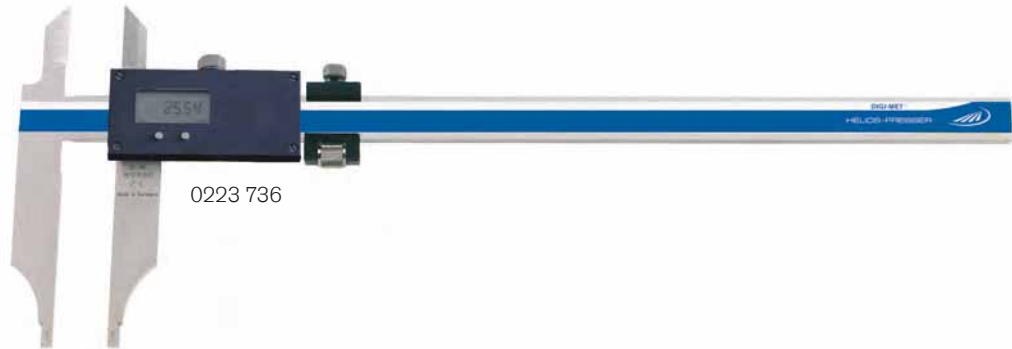

0223 736

Model

- Stainless steel
- LCD display 10 mm
- Locking screw
- Knife points
- Factory standard
- Stepped jaws: 30 mm

Functions

- ON / OFF
- Set to zero at any point
- mm / inch switching
- Hold
- Data output Opto RS 232
- PRESET-Function (setting a numerical value)

Delivery

- Wooden case

▶◀	🏠	Measuring range		Jaw length		Reading		Error limit	Order no.	List price EUR
		mm	inch	mm	inch	mm	inch	mm		
With knife points, without fine adjustment										
	▪	0 - 1500	0 - 59	200	8.0	0.01	.0005	0.1	0222 734	2677.00
	▪	0 - 2000	0 - 79	200	8.0	0.01	.0005	0.12	0222 736	3212.00
With knife points, with fine adjustment										
	▪	0 - 1500	0 - 59	200	8.0	0.01	.0005	0.1	0223 734	2856.00
	▪	0 - 2000	0 - 79	200	8.0	0.01	.0005	0.12	0223 736	3309.00



0996705

0996701

Accessories

	Order no.	List price EUR
Battery, 3V-Lithium, CR 2032	0220 704	3.90
Data cable opto to RS232	0996 701	77.00
Data cable opto to USB	0996 705	147.00



0224 / 0225 DIGI-MET® Workshop calipers long version



1



0224 736



0225 736

Model

- Stainless steel
- LCD display 10 mm
- Locking screw
- Without knife points
- Factory standard
- Stepped jaws: 30 mm

Functions

- ON / OFF
- Set to zero at any point
- mm / inch switching
- Hold
- Data output Opto RS 232
- PRESET-Function (setting a numerical value)

Delivery

- Wooden case

Icon	Measuring range		Jaw length		Reading		Error limit	Order no.	List price	
	mm	inch	mm	inch	mm	inch				mm
Without fine adjustment										
▪	0 - 1500	0 - 59	200	8.0	0.01	.0005	0.1	0224 734	2421.00	
▪	0 - 2000	0 - 79	200	8.0	0.01	.0005	0.12	0224 736	2934.00	
With fine adjustment										
▪	0 - 1500	0 - 59	200	8.0	0.01	.0005	0.1	0225 734	2552.00	
▪	0 - 2000	0 - 79	200	8.0	0.01	.0005	0.12	0225 736	3029.00	



0996705



0996701

Accessories

	Order no.	List price
		EUR
Battery, 3V-Lithium, CR 2032	0220 704	3.90
Data cable opto to RS232	0996 701	77.00
Data cable opto to USB	0996 705	147.00



1351 DIGI-MET® Workshop calipers with cross points



1351 522

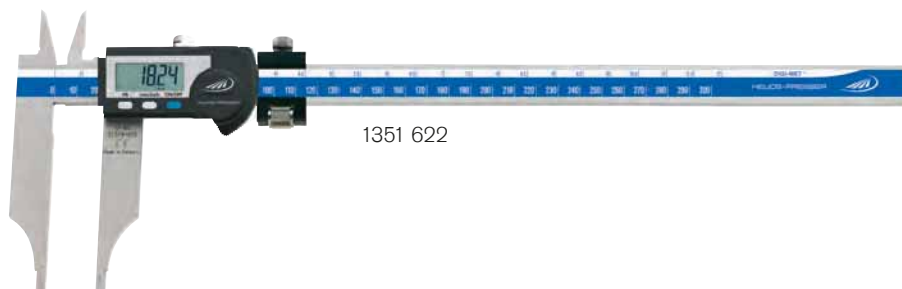

1351 622

Model

- Stainless steel
- DIN 862
- Protection class IP65
- LCD display
- 10 mm with measuring range 300 mm;
- 12.5 mm from measuring range 500 mm
- Locking screw
- Inside cross points
- Three way measurement

Functions

- ON / OFF
- **Quick-Start**
- **Quick-Lock** (key lock)
- Set to zero at any point
- mm / inch switching
- PRESET-Function (setting a numerical value)
- Variable data output RS 232 + Digimatic + USB

Delivery

- Wooden case

Marked	Measuring range		Jaw length		Reading		Error limit	Order no.	List price
	mm	inch	mm	inch	mm	inch			
Without fine adjustment									
	0 - 300	0 - 12	90	3.5	0.01	.0005	0.03	1351 522	554.00
	0 - 500	0 - 20	125	5.0	0.01	.0005	0.03	1351 528	717.00
With fine adjustment									
	0 - 300	0 - 12	90	3.5	0.01	.0005	0.03	1351 622	591.00
	0 - 500	0 - 20	125	5.0	0.01	.0005	0.03	1351 628	784.00



1998720

1997501

1998501

Accessories

	Order no.	List price
Battery, 3V-Lithium, CR 2032	0220 704	3.90
Data cable DATA VARIABLE to USB	1998 720	72.00
Data cable DATA VARIABLE to digimatic	1998 501	64.00
Data cable DATA VARIABLE to RS232	1997 501	50.00



1338 DIGI-MET® Workshop caliper PRISMA



1

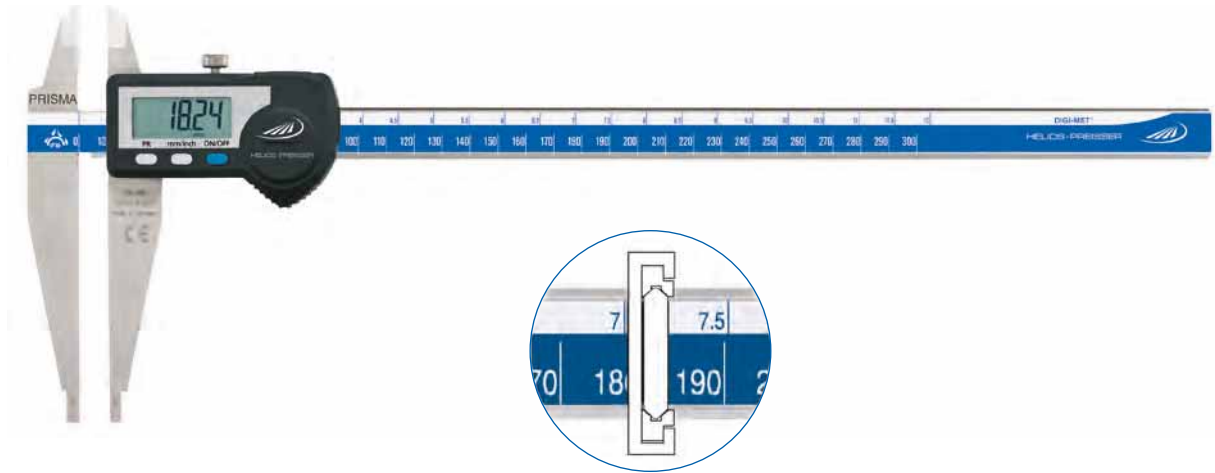

Model

- Double prisma guide with excellent sliding characteristics
- Stainless steel
- Accuracy in accordance to DIN 862
- Protection class IP65
- LCD display 10 mm
- Locking screw
- Knife points
- Stepped jaws for inside measurement 10 mm

Functions

- ON / OFF
- **Quick-Start**
- **Quick-Lock** (key lock)
- Set to zero at any point
- mm / inch switching
- PRESET-Function (setting a numerical value)
- Variable data output RS 232 + Digimatic + USB

Delivery

- Wooden case

Icon	Measuring range		Jaw length		Reading		Error limit	Order no.	List price
	mm	inch	mm	inch	mm	inch	mm		EUR
▪	0 - 300	0 - 12	90	3.5	0.01	.0005	0.03	1338 522	475.00



Accessories

	Order no.	List price
		EUR
Battery, 3V-Lithium, CR 2032	0220 704	3.90
Data cable DATA VARIABLE to RS232	1997 501	50.00
Data cable DATA VARIABLE to digimatic	1998 501	64.00
Data cable DATA VARIABLE to USB	1998 720	72.00



0228 DIGI-MET® Workshop calipers, lightweight

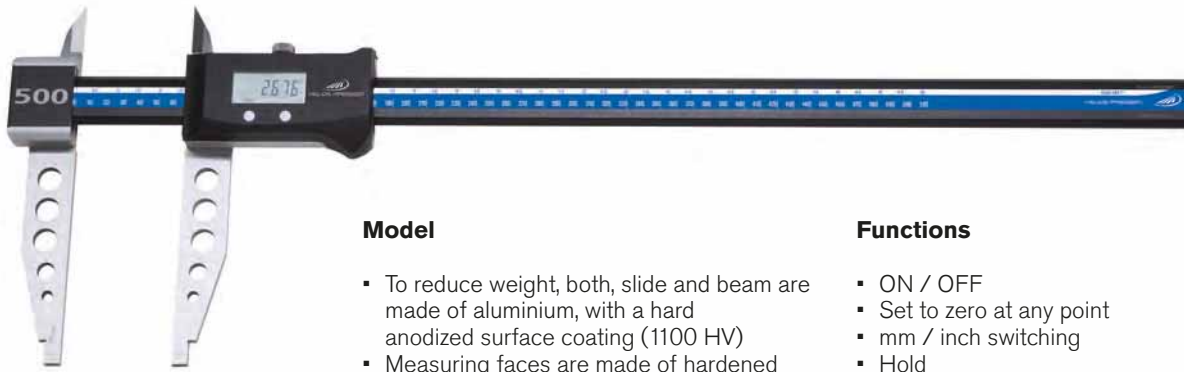

Model

- To reduce weight, both, slide and beam are made of aluminium, with a hard anodized surface coating (1100 HV)
- Measuring faces are made of hardened stainless steel
- Factory standard
- Smooth movement due to the double V-guide
- LCD display
- Locking screw
- Knife points

Functions

- ON / OFF
- Set to zero at any point
- mm / inch switching
- Hold
- PRESET-Function (setting a numerical value)

Delivery

- Wooden case

✕	🏠	Measuring range		Jaw length		Reading		Error limit	Order no.	List price
		mm	inch	mm	inch	mm	inch	mm		EUR
		0 - 300	0 - 12	90	3.5	0.01	.0005	0.03	0228 701	493.00
		0 - 500	0 - 20	150	6.0	0.01	.0005	0.03	0228 702	686.00
		0 - 800	0 - 31	150	6.0	0.01	.0005	0.08	0228 703	964.00
		0 - 1000	0 - 39	150	6.0	0.01	.0005	0.08	0228 704	1137.00
	▪	0 - 1500	0 - 59	150	6.0	0.01	.0005	0.1	0228 724	2869.00
	▪	0 - 2000	0 - 79	150	6.0	0.01	.0005	0.12	0228 726	3410.00

Accessories

Battery, 3V-Lithium, CR 2032

Order no.

0220 704

List price

EUR
3.90

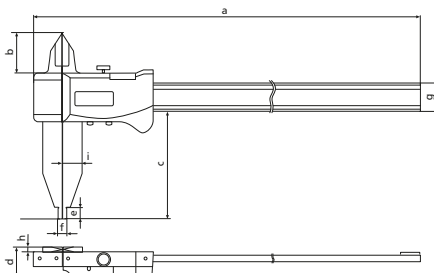

Measuring range mm	a	b	c	d	e	f	g	h	i
300	450	33	90	24.5	10	10	25.0	4.5	17.0
500	726	42	150	33.5	15	20	31.9	6.0	29.0
800	1026	42	150	33.5	15	20	31.9	6.0	29.0
1000	1226	42	150	33.5	15	20	31.9	6.0	29.0
1500	1726	42	150	33.5	15	20	31.9	6.0	29.0
2000	2226	42	150	33.5	15	20	31.9	6.0	29.0



HELIOS · PREISSER

1351 DIGI-MET® Caliper with cross points

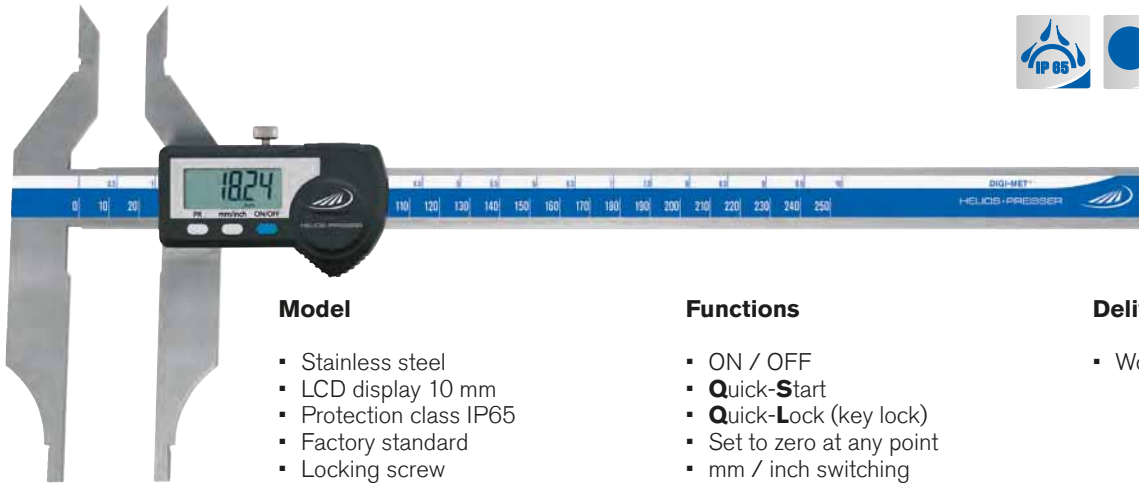

Model

- Stainless steel
- LCD display 10 mm
- Protection class IP65
- Factory standard
- Locking screw
- Inside cross points 55 mm

Functions

- ON / OFF
- **Quick-Start**
- **Quick-Lock** (key lock)
- Set to zero at any point
- mm / inch switching
- PRESET-Function (setting a numerical value)
- Variable data output RS 232 + Digimatic + USB

Delivery

- Wooden case

Measuring range	Jaw length		Reading		Error limit	Order no.	List price	
	mm	inch	mm	inch				mm
0 - 250	0 - 10	80	3.2	0.01	.0005	0.03	1351 920	499.00





1320 DIGI-MET® Pocket caliper with 40 mm inside cross points



DIN
862



Model

- Inductive measuring system, resistant to damp and sweat
- Stainless steel
- LCD display 7.5 mm
- DIN 862
- Locking screw
- Inside cross points
- Four way measurement

Functions

- ON / OFF
- **Quick-Start**
- **Quick-Lock** (key lock)
- Set to zero at any point
- mm / inch switching
- Variable data output
RS 232 + Digimatic + USB

Delivery

- Plastic case

✕	Measuring range		Jaw length		Reading		Error limit	Depth gauge	Order no.	List price
	mm	inch	mm	inch	mm	inch	mm	dia. mm		EUR
▪	0 - 150	0 - 6	40	1.6	0.01	.0005	0.03	round 1.5	1320 518	395.00

Accessories



1998720



1998501



1997501

Battery, 3V-Lithium, CR 2032

Data cable DATA VARIABLE to digimatic

Data cable DATA VARIABLE to RS232

Data cable DATA VARIABLE to USB

Order no.

0220 704

1998 501

1997 501

1998 720

List price

EUR

3.90

64.00

50.00

72.00



HELIOS · PREISSER

0262 Caliper for external locking grooves

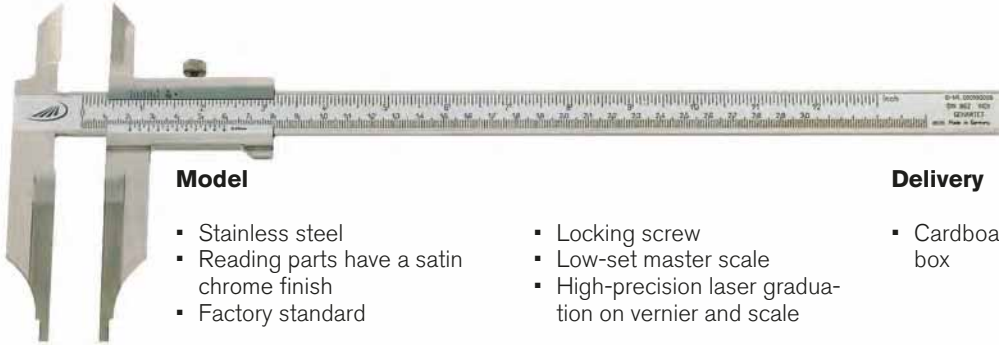

Model

- Stainless steel
- Reading parts have a satin chrome finish
- Factory standard
- Locking screw
- Low-set master scale
- High-precision laser graduation on vernier and scale

Delivery

- Cardboard box

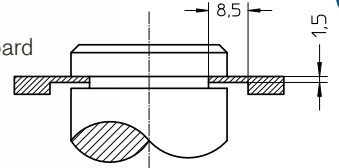

✕	Measuring range		Jaw length		Reading		Error limit	Order no.	List price
	mm	inch	mm	inch	mm	inch			
	0 - 300	0 - 12	90	3.5	0.05	1/128	0.03	0262 503	EUR 271.00

1353 DIGI-MET® Caliper for external locking grooves

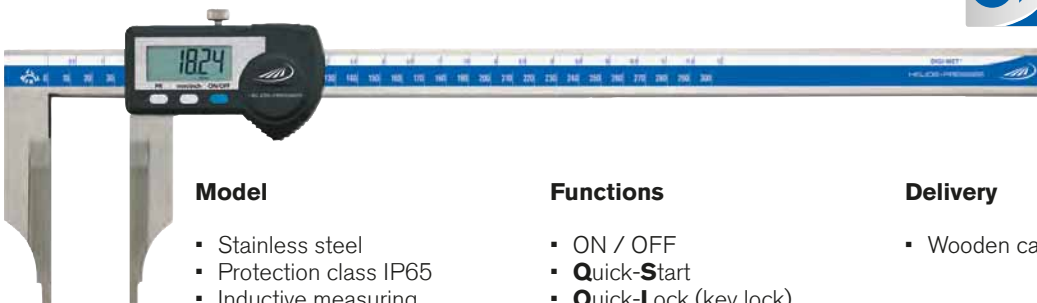

Model

- Stainless steel
- Protection class IP65
- Inductive measuring system
- LCD display 10 mm
- Locking screw
- Factory standard

Functions

- ON / OFF
- Quick-Start
- Quick-Lock (key lock)
- Set to zero at any point
- mm / inch switching
- PRESET-Function (setting a numerical value)
- Variable data output RS 232 + Digimatic + USB

Delivery

- Wooden case

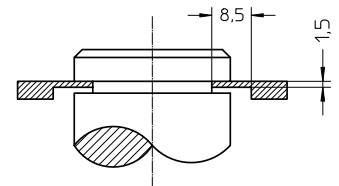

✕	Measuring range		Jaw length		Reading		Error limit	Order no.	List price
	mm	inch	mm	inch	mm	inch			
	0 - 300	0 - 12	90	3.5	0.01	.0005	0.03	1353 522	EUR 491.00



1998720 1997501 1998501

Accessories

	Order no.	List price
Battery, 3V-Lithium, CR 2032	0220 704	EUR 3.90
Data cable DATA VARIABLE to RS232	1997 501	50.00
Data cable DATA VARIABLE to digimatic	1998 501	64.00
Data cable DATA VARIABLE to USB	1998 720	72.00



0252 Brake drum vernier calipers

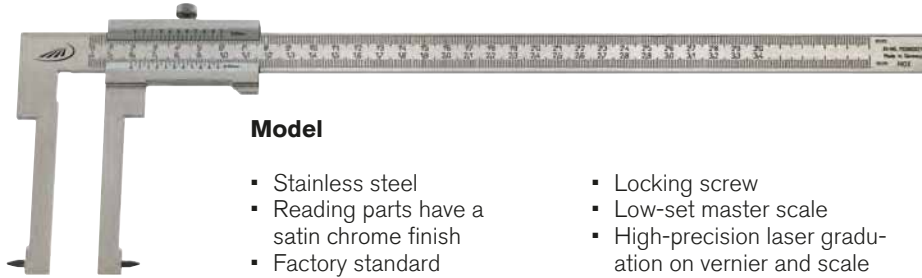

Model

- Stainless steel
- Reading parts have a satin chrome finish
- Factory standard
- Locking screw
- Low-set master scale
- High-precision laser graduation on vernier and scale

Delivery

- Cardboard box

✂	☞	Measuring range internal mm	Measuring range external mm	Jaw length mm	Reading mm	Error limit mm	Order no.	List price EUR
		40 - 300	0 - 300	90	0.05	0.1	0252 201	143.00
		50 - 500	0 - 500	150	0.05	0.14	0252 202	275.00
		50 - 600	0 - 600	200	0.05	0.16	0252 203	301.00

0252 Replacement points (pair) for brake drum vernier calipers



✂	☞	Description	Order no.	List price EUR
		For measuring range 300 mm	0252 291	4.40
		For measuring range 500 + 600 mm	0252 293	5.40

0253 Brake disc inspection gauges

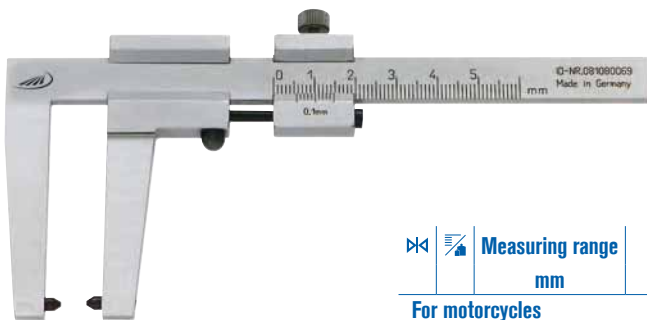

Model

- Special steel
- Reading parts have a satin chrome finish
- Factory standard
- Locking screw
- With trailing vernier
- High-precision laser graduation on vernier and scale

Delivery

- Cardboard box

✂	☞	Measuring range mm	Jaw length mm	Reading mm	Error limit mm	Order no.	List price EUR
		For motorcycles					
		0 - 50	30	0.1	0.1	0253 300	84.00
		For cars					
		0 - 50	50	0.1	0.14	0253 301	84.00
		0 - 60	80	0.1	0.14	0253 311	109.00
		For trucks					
		0 - 80	50	0.1	0.16	0253 302	107.00

0253 Replacement points (pair) for brake disc inspection gauges



✂	☞	Order no.	List price EUR
		0253 391	3.90



HELIOS · PREISSER

1352 DIGI-MET® Calipers for internal grooves



1

Model

- Stainless steel
- LCD display 7.5 mm
- Factory standard
- Locking screw
- IP67: up to 200 mm
- IP65: 250 and 300 mm

Functions

- ON / OFF
- Quick-Start
- Quick-Lock (key lock)
- Set to zero at any point
- mm / inch switching
- PRESET-Function (setting a numerical value)

Delivery

- Variable data output RS 232 + Digimatic + USB
- Wooden case
- Setting ring sold separately

Measuring range	Jaw length		Reading		Error limit	Order no.	List price
	mm	mm	inch	mm			
10 - 160	25	1.0	0.01	.0005	0.06	1352 516	388.00
20 - 160	40	1.5	0.01	.0005	0.06	1352 517	437.00
26 - 200	60	2.3	0.01	.0005	0.06	1352 518	800.00
30 - 250	80	3.1	0.01	.0005	0.06	1352 520	900.00
35 - 300	100	3.9	0.01	.0005	0.06	1352 522	939.00

0258 Calipers for internal grooves



Model

- Stainless steel
- Reading parts have a satin chrome finish
- Factory standard

Delivery

- Locking screw
- Low-set master scale
- High-precision laser graduation on vernier and scale
- Cardboard box

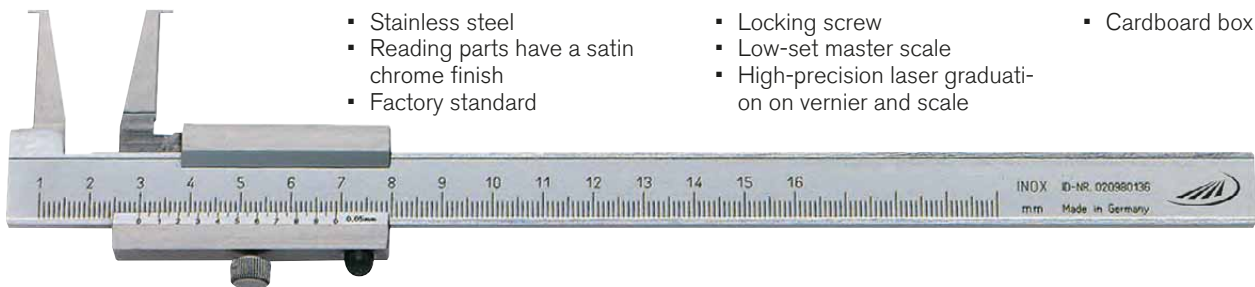

Measuring range	Jaw length		Reading	Error limit	Order no.	List price
	mm	mm				
10 - 160	25	1.0	0.05	0.1	0258 501	144.00
20 - 160	40	1.5	0.05	0.1	0258 502	192.00
26 - 200	60	2.3	0.05	0.1	0258 503	295.00
30 - 250	80	3.1	0.05	0.1	0258 504	333.00
35 - 300	100	3.9	0.05	0.1	0258 505	372.00

Dimensions of 0258 and 1352

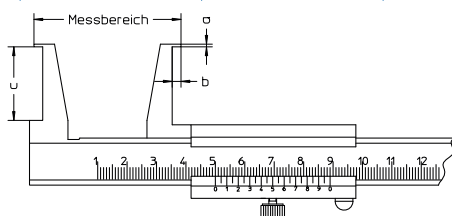

Measuring range mm	a	b	c
10 - 160	0.9	3.0	25
20 - 160	2.0	5.0	40
26 - 200	3.0	7.0	60
30 - 250	4.0	8.5	80
35 - 300	5.0	10.0	100



0260 Calipers for 3/5 point measurement



Model

- Stainless steel
- Reading parts have a satin chrome finish
- Locking screw
- Factory standard

Delivery

- Cardboard box

Measuring range	Reading		Error limit	Order no.	List price
	mm	mm inch			
3 point measurement					
4 - 40	0.05	1/128	0.05	0260 501	74.00
5 point measurement					
2 - 40	0.05	1/128	0.05	0260 502	74.00



0597 Chamfer gauge



Model

- Stainless steel
- Reading 0.1 mm
- Reading parts have a satin chrome finish
- For simultaneously testing of the chamfer angle and the dimensional accuracy
- Dimensions: 48 x 30 x 8.5 mm

Delivery

- 3 interchangeable blades: 30°, 45°, 60°
- Wooden case

Icon	Measuring range	Reading	Order no.	List price
	mm	mm		EUR
	0 - 10	0.10	0597 301	175.00

1

0597 Radius gauge

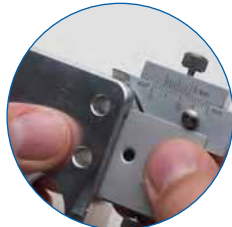

Model

- To determine radius size workpieces
- Stainless steel
- Reading parts are satin chrome finished

Delivery

- Wooden case

Icon	Measuring range	Reading	Order no.	List price
	mm	mm		EUR
	0 - 10	0.10	0597 305	175.00



0268 Gear tooth calipers

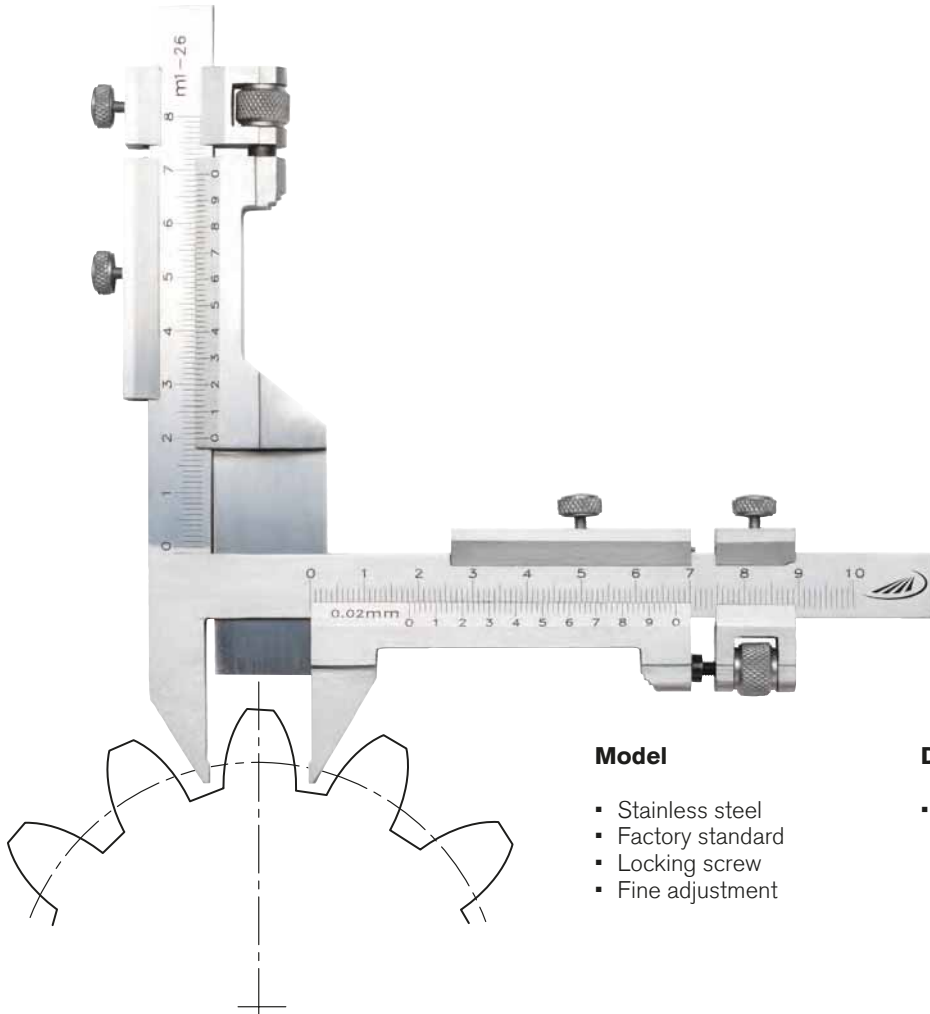

Model

- Stainless steel
- Factory standard
- Locking screw
- Fine adjustment

Delivery

- Wooden case

✂	🏠	Module	Reading mm	Error limit mm	Order no.	List price EUR
Hardened jaw tips						
		1 - 26	0.02	0.1	0268 201	308.00
Carbide tipped jaw tips						
		1 - 26	0.02	0.1	0268 211	376.00



0281 Vernier depth gauges



**DIN
862**

1



0281 501

Model

- Stainless steel
- Reading parts have a satin chrome finish
- DIN 862
- Low-set master scale
- Locking screw
- Measuring rod with interchangeable pin
- Double sided scale
- High-precision laser graduation on vernier and scale

Delivery

- Cardboard box

Icon	Measuring range mm	Length of beam mm	Reading mm	Error limit mm	Order no.	List price EUR
▪	0 - 150	100	0.05	0.05	0281 501	89.00
▪	0 - 200	100	0.05	0.05	0281 502	92.00
▪	0 - 300	150	0.05	0.05	0281 505	115.00

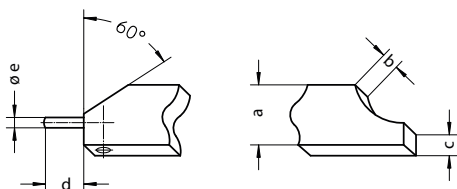

Measuring range mm	a	b	c	d	e
150 - 200	8.0	3.0	3.5	8.0	1.5
250 - 300	12.0	4.0	4.0	8.0	2.0



0282 Vernier depth gauges



**DIN
862**



Model

- DIN 862
- Locking screw
- Straight measuring rod
- Low-set master scale
- High-precision laser graduation on vernier and scale

Delivery

- Cardboard box for calipers up to 1000 mm, larger measuring ranges are individually packed

✕	Measuring range mm	Length of beam mm	Reading mm	Error limit mm	Order no.	List price EUR
Stainless steel, vernier + scale satin chrome finished						
▪	0 - 150	100	0.05	0.05	0282 501	78.00
▪	0 - 200	100	0.05	0.05	0282 502	82.00
▪	0 - 300	100	0.05	0.05	0282 503	93.00
▪	0 - 300	150	0.05	0.05	0282 505	99.00
▪	0 - 500	150	0.05	0.07	0282 507	152.00
▪	0 - 500	250	0.05	0.07	0282 508	232.00
▪	0 - 800	250	0.05	0.10	0282 509	387.00
▪	0 - 1000	250	0.05	0.12	0282 510	548.00

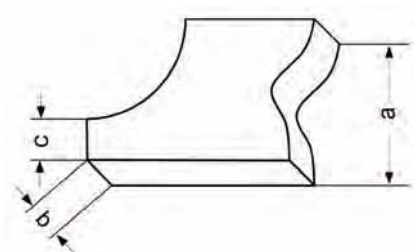

Measuring range mm	a	b	c
150 - 200	8.0	3.0	3.5
250 - 500	12.0	4.0	4.0
500 - 1000	20.0	5.0	10.0
1500	25.0	6.0	13.0



0286 Vernier depth gauges



**DIN
862**

1



Reversible measuring rod

Model

- DIN 862
- Locking screw
- Reversible, L-shaped measuring rod
- Scales on both sides
- Low-set master scale

Delivery

- Cardboard box for calipers up to 1000 mm, larger measuring ranges are individually packed

- High-precision laser graduation on vernier and scale

	Measuring range mm	Length of beam mm	Reading mm	Error limit mm	Order no.	List price EUR
Stainless steel, vernier + scale satin chrome finished						
▪	0 - 150	100	0.05	0.05	0286 501	93.00
▪	0 - 200	100	0.05	0.05	0286 502	94.00
▪	0 - 300	150	0.05	0.05	0286 505	115.00
▪	0 - 500	150	0.05	0.07	0286 507	184.00
▪	0 - 500	250	0.05	0.07	0286 508	388.00
▪	0 - 800	250	0.05	0.10	0286 509	523.00
▪	0 - 1000	250	0.05	0.12	0286 510	666.00

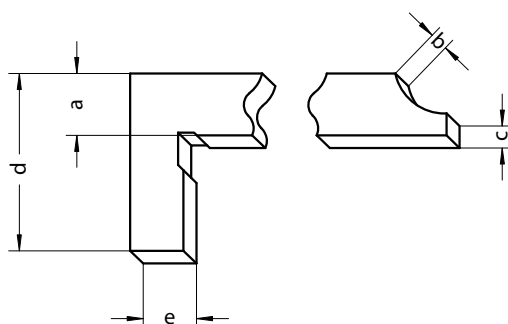

Measuring range mm	a	b	c	d	e
150 - 200	8.0	3.0	3.5	20.0	5.0
250 - 500	12.0	4.0	4.0	28	10
500 - 1000	20.0	5.0	10.0	70.0	19.0
1500	25.0	6.0	13.0	90.0	24.0



0292 Offset vernier depth gauges

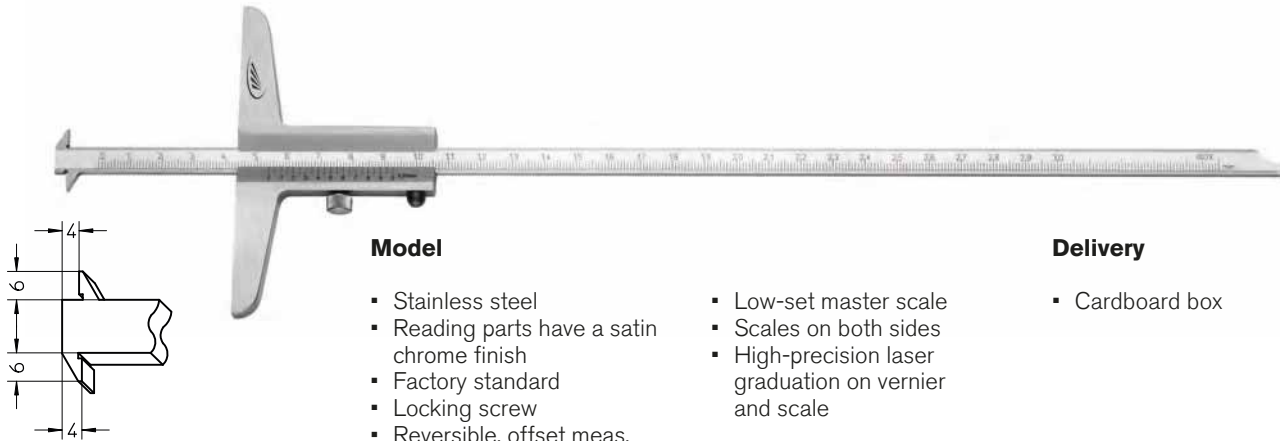

Model

- Stainless steel
- Reading parts have a satin chrome finish
- Factory standard
- Locking screw
- Reversible, offset meas. rod
- Low-set master scale
- Scales on both sides
- High-precision laser graduation on vernier and scale

Delivery

- Cardboard box

Measuring range	Length of beam	Reading	Error limit	Order no.	List price
mm	mm	mm	mm		EUR
0 - 200	100	0.05	0.05	0292 501	88.00
0 - 300	100	0.05	0.05	0292 502	100.00

0294 Vernier depth gauges with sliding measuring base

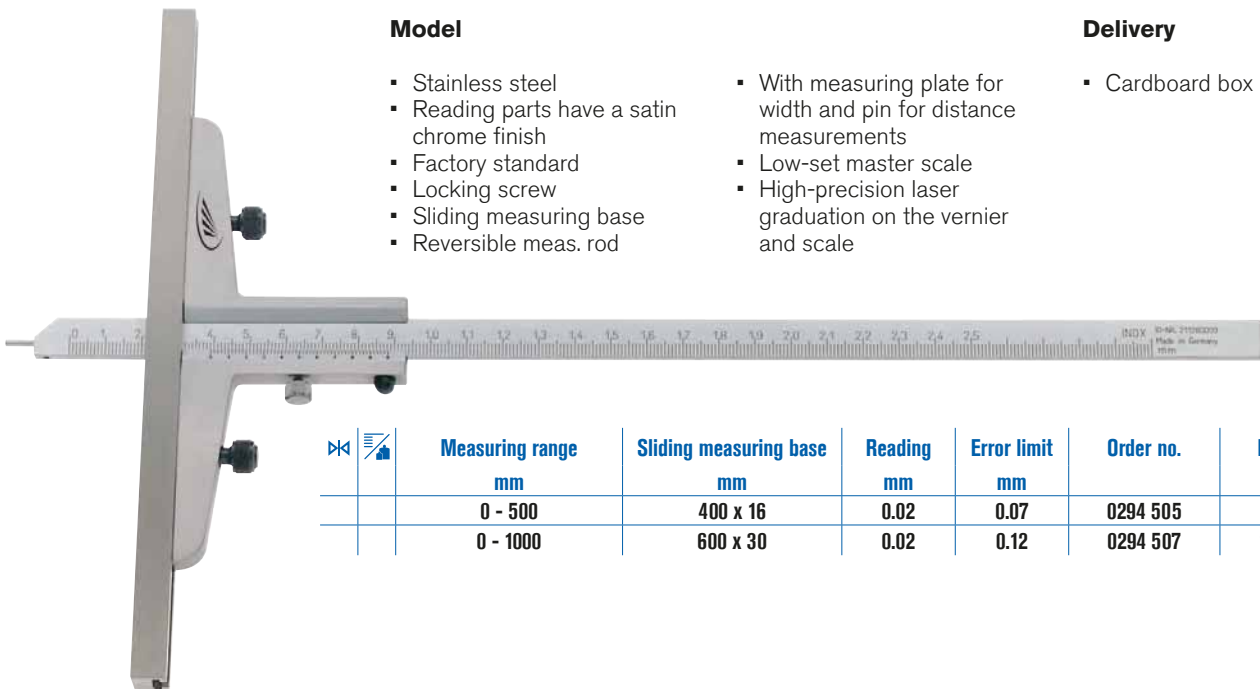

Model

- Stainless steel
- Reading parts have a satin chrome finish
- Factory standard
- Locking screw
- Sliding measuring base
- Reversible meas. rod
- With measuring plate for width and pin for distance measurements
- Low-set master scale
- High-precision laser graduation on the vernier and scale

Delivery

- Cardboard box

Measuring range	Sliding measuring base	Reading	Error limit	Order no.	List price
mm	mm	mm	mm		EUR
0 - 500	400 x 16	0.02	0.07	0294 505	750.00
0 - 1000	600 x 30	0.02	0.12	0294 507	1581.00

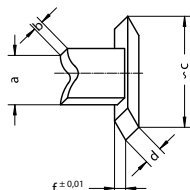
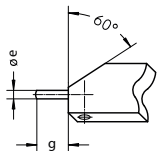

Measuring range	a	b	c	d	e	f	g
mm							
250 - 500	12.0	4.0	18.0	6.0	2.0	2.0	8.0
750 - 1000	20.0	5.0	30.0	8.0	3.0	3.0	8.0



HELIOS · PREISSER

1360 DIGI-MET® Depth gauges

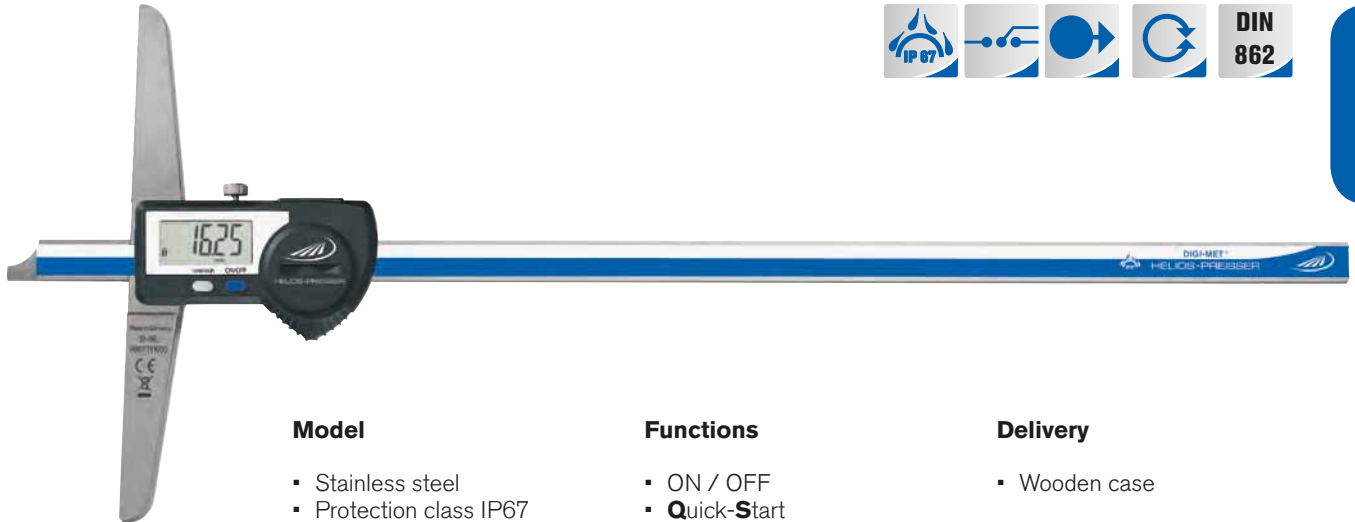

1

Model

- Stainless steel
- Protection class IP67
- From 1000 mm protection class IP65
- LCD display 7.5 mm
- DIN 862
- Locking screw
- Straight measuring rod

Functions

- ON / OFF
- **Quick-Start**
- **Quick-Lock** (key lock)
- Set to zero at any point
- mm / inch switchin
- Variable data output RS 232 + Digimatic + USB

Delivery

- Wooden case

▶▶	Measuring range		Length of beam mm	Reading		Error limit mm	Order no.	List price EUR
	mm	inch		mm	inch			
▪	0 - 150	0 - 6	100	0.01	.0005	0.03	1360 716	329.00
▪	0 - 200	0 - 8	100	0.01	.0005	0.03	1360 718	373.00
▪	0 - 300	0 - 12	150	0.01	.0005	0.03	1360 722	419.00
▪	0 - 500	0 - 20	150	0.01	.0005	0.03	1360 728	481.00
▪	0 - 1000	0 - 39	250	0.01	.0005	0.04	1360 734	1370.00
▪	0 - 1500	0 - 59	250	0.01	.0005	0.05	1360 738	2090.00



Accessories

	Order no.	List price EUR
Battery, 3V-Lithium, CR 2032	0220 704	3.90
Data cable DATA VARIABLE to RS232	1997 501	50.00
Data cable DATA VARIABLE to digimatic	1998 501	64.00
Data cable DATA VARIABLE to USB	1998 720	72.00



1362 DIGI-MET® Depth gauges



**DIN
862**

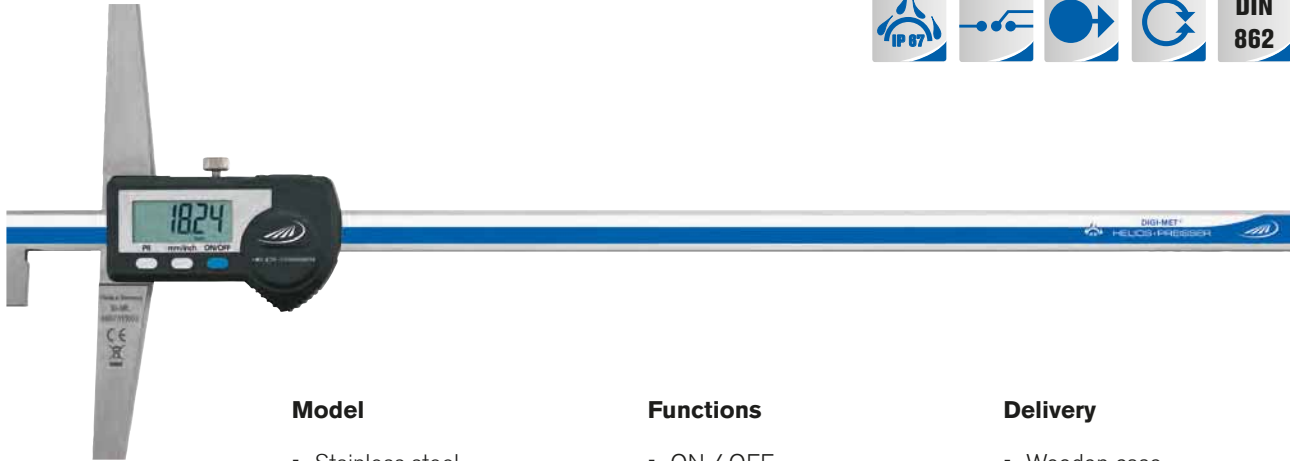

Model

- Stainless steel
- Protection class IP67
- LCD display 7,5 mm
- DIN 862
- Locking screw
- L-shaped measuring rod
- Larger measuring ranges are available upon request

Functions

- ON / OFF
- Set to zero at any point
- mm / inch switching
- **Quick-Start**
- **Quick-Lock** (key lock)
- PRESET-Function (setting a numerical value)
- Variable data output RS 232 + Digimatic + USB

Delivery

- Wooden case

Marked	Measuring range		Length of beam mm	Reading		Error limit mm	Order no.	List price EUR
	mm	inch		mm	inch			
▪	0 - 300	0 - 12	150	0.01	.0005	0.03	1362 722	429.00
▪	0 - 500	0 - 20	150	0.01	.0005	0.03	1362 728	499.00



1998720

1997501

1998501

Accessories

Battery, 3V-Lithium, CR 2032

Data cable DATA VARIABLE to RS232

Data cable DATA VARIABLE to digimatic

Data cable DATA VARIABLE to USB

Order no.

0220 704

1997 501

1998 501

1998 720

List price

EUR

3.90

50.00

64.00

72.00

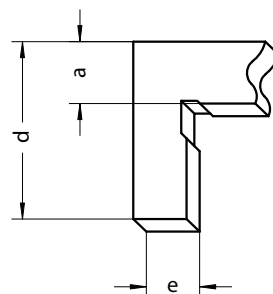

Measuring range mm	a	e	d
300	11.6	10	28
500	11.6	10	28



1364 DIGI-MET® Depth gauges

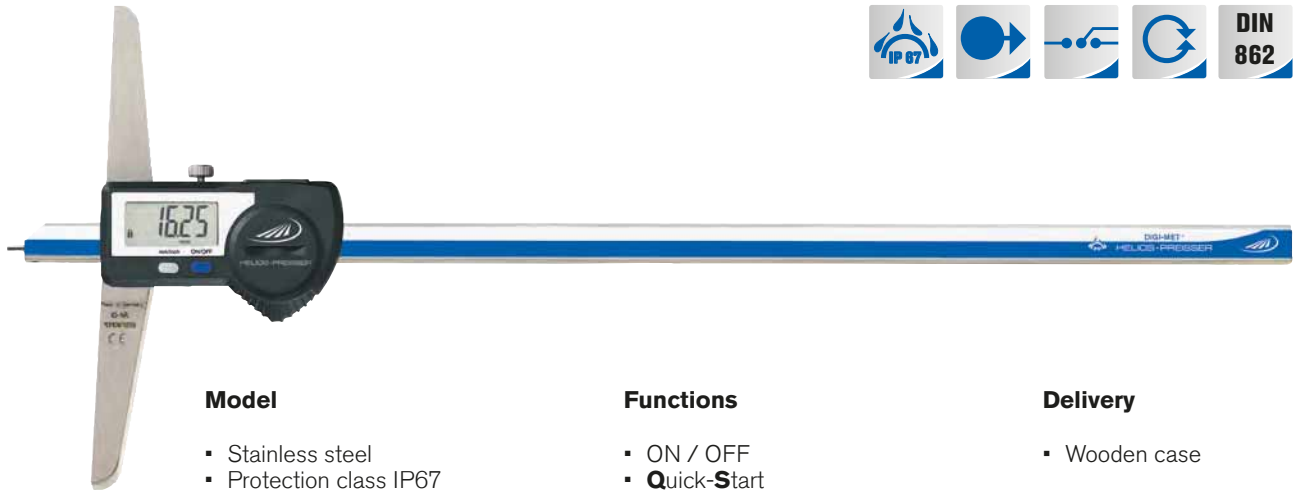

1

Model

- Stainless steel
- Protection class IP67
- LCD display 7.5 mm
- DIN 862
- Locking screw
- Replaceable pin
- Larger measuring ranges are available upon request

Functions

- ON / OFF
- **Quick-Start**
- **Quick-Lock** (key lock)
- Set to zero at any point
- mm / inch switching
- Variable data output RS 232 + Digimatic + USB

Delivery

- Wooden case

▶▶	Measuring range		Length of beam	Reading		Error limit	Order no.	List price
	mm	inch		mm	mm			
▪	0 - 200	0 - 8	100	0.01	.0005	0.03	1364 722	406.00
▪	0 - 300	0 - 12	150	0.01	.0005	0.03	1364 728	452.00

Accessories



1998720 1997501 1998501

	Order no.	List price
Battery, 3V-Lithium, CR 2032	0220 704	3.90
Data cable DATA VARIABLE to RS232	1997 501	50.00
Data cable DATA VARIABLE to digimatic	1998 501	64.00
Data cable DATA VARIABLE to USB	1998 720	72.00

0276 Replacement measuring pin



▶▶	Diameter	Order no.	List price
	mm		EUR
	2	0276 711	6.40



1366 DIGI-MET® Offset depth gauges

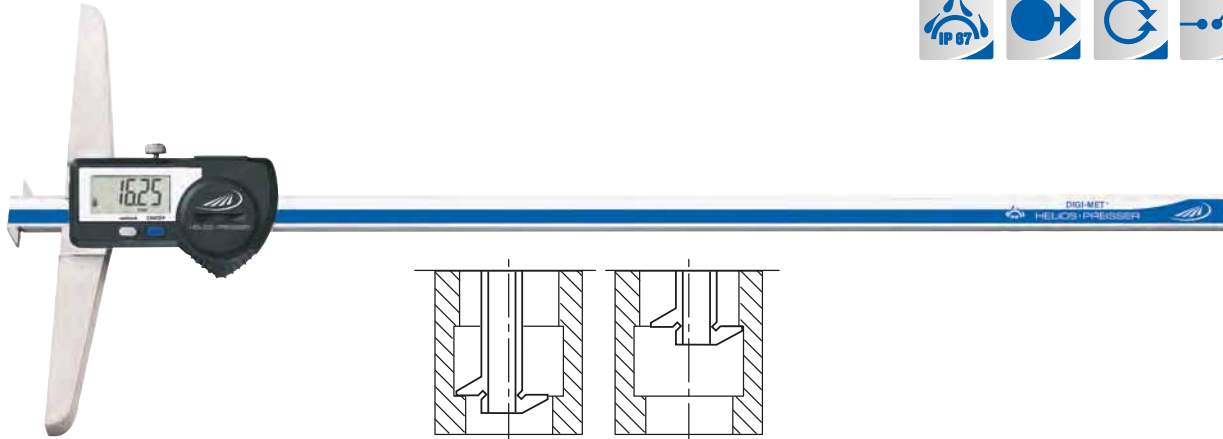

Model

- Stainless steel
- Inductive measuring system, protection class IP67
- LCD display 7,5 mm
- Factory standard
- Housing and operating keys have an excellent chemical resistance
- Locking screw

Functions

- ON / OFF
- **Quick-Start**
- **Quick-Lock** (key lock)
- Set to zero at any point
- mm / inch switching
- Variable data output RS 232 + Digimatic + USB

Delivery

- Wooden case

Marked *	Measuring range		Length of beam	Reading		Error limit	Order no.	List price
	mm	inch		mm	inch			
▪	0 - 200	0 - 8	100	0.01	.0005	0.03	1366 718	422.00
▪	0 - 300	0 - 12	150	0.01	.0005	0.03	1366 722	510.00
▪	0 - 500	0 - 20	150	0.01	.0005	0.03	1366 728	642.00



1998720

1997501

1998501

Accessories

- Battery, 3V-Lithium, CR 2032**
- Data cable DATA VARIABLE to RS232**
- Data cable DATA VARIABLE to digimatic**
- Data cable DATA VARIABLE to USB**

Order no.

List price

EUR

0220 704

3.90

1997 501

50.00

1998 501

64.00

1998 720

72.00

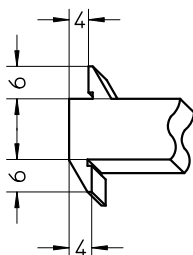



1368 DIGI-MET® Depth gauges

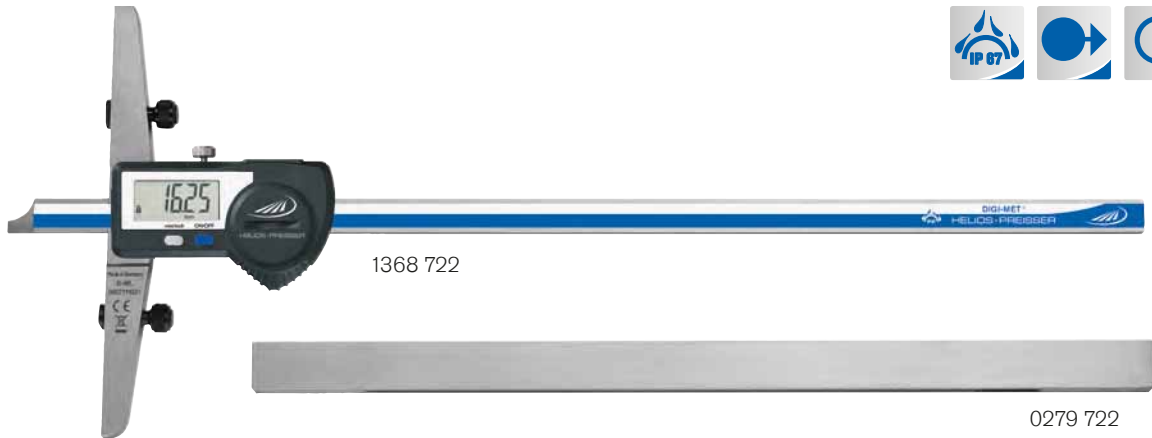

1

Model

- Stainless steel
- Inductive measuring system, protection class IP67
- LCD display 7.5 mm
- Locking screw

Functions

- ON / OFF
- **Quick-Start**
- **Quick-Lock** (key lock)
- Set to zero at any point
- mm / inch switching
- Variable data output RS 232 + Digimatic + USB

Delivery

- Wooden box
- **The sliding measuring base and screws must be ordered separately**

Icon	Measuring range		Length of beam mm	Reading		Error limit mm	Order no.	List price EUR
	mm	inch		mm	inch			
	0 - 300	0 - 12	150	0.01	.0005	0.03	1368 722	429.00
	0 - 500	0 - 20	150	0.01	.0005	0.03	1368 728	489.00



1998720 1997501 1998501

Accessories

Accessories	Order no.	List price EUR
Battery, 3V-Lithium, CR 2032	0220 704	3.90
Data cable DATA VARIABLE to RS232	1997 501	50.00
Data cable DATA VARIABLE to digimatic	1998 501	64.00
Data cable DATA VARIABLE to USB	1998 720	72.00

0279 Sliding measuring base made of stainless steel



Delivery

- Bolts included

Icon	Dimensions mm	Order no.	List price EUR
	300 x 16	0279 722	272.00
	400 x 16	0279 723	284.00
	500 x 16	0279 724	296.00

Accessories

Accessories	Order no.	List price EUR
Fixture for sliding measuring base, two parts	0279 792	21.50



1371i DIGI-MET® Depth gauges IP67 with integrated wireless



1371 41660

integrated IW wireless

Wireless Data Transmission

Model

- Stainless steel
- Inductive measuring system, protection class IP67
- DIN 862
- Locking screw
- LCD display 11 mm
- Measuring pin dia. 1.5 mm

Functions

- ON / OFF
- **Quick-Start**
- **Quick-Lock** (key lock)
- PRESET-Function (setting a numerical value)
- Set to zero at any point
- mm / inch switching
- Integrated Wireless

Delivery

- Plastic case



More information on our i-series and Integrated Wireless on page 252

Marked *	Measuring range	Length of beam		Reading		Error limit	Order no.	List price
		mm	inch	mm	inch			
▪	0 - 150	0 - 6	100	0.01	.0005	0.03	1371 41660	432.00
▪	0 - 200	0 - 8	100	0.01	.0005	0.03	1371 41860	459.00
▪	0 - 300	0 - 12	150	0.01	.0005	0.04	1371 42260	516.00
▪	0 - 500	0 - 20	150	0.01	.0005	0.05	1371 42860	585.00



1998780

Accessories

	Order no.	List price
Battery, 3V-Lithium, CR 2032	0220 704	3.90
i-Stick USB-receiver for Integrated Wireless	1998 780	95.00

Integrated Wireless is intended to be sold within the European Economic Area only



1371 DIGI-MET® Depth gauges IP67



1371 416

Model

- Stainless steel
- Inductive measuring system, protection class IP67
- DIN 862
- Locking screw
- LCD display 11 mm
- Measuring pin dia. 1.5 mm

Functions

- ON / OFF
- **Quick-Start**
- **Quick-Lock** (key lock)
- PRESET-Function (setting a numerical value)
- Set to zero at any point
- mm / inch switching

Delivery

- Plastic case



Product video

⊗	Measuring range		Length of beam mm	Reading		Error limit mm	Order no.	List price EUR
	mm	inch		mm	inch			
▪	0 - 150	0 - 6	100	0.01	.0005	0.03	1371 416	388.00
▪	0 - 200	0 - 8	100	0.01	.0005	0.03	1371 418	426.00
▪	0 - 300	0 - 12	150	0.01	.0005	0.04	1371 422	475.00
▪	0 - 500	0 - 20	150	0.01	.0005	0.05	1371 428	547.00

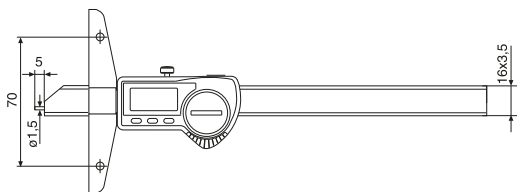

Accessories

Battery, 3V-Lithium, CR 2032

Order no.	List price EUR
0220 704	3.90

1271 Extension depth attachment base



1271 451

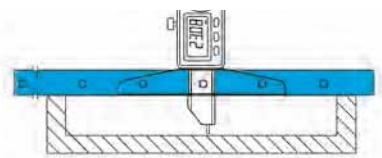

⊗	Measuring bridge length mm	Order no.	List price EUR
	200	1271 451	89.00
	300	1271 452	103.00

1271 Measuring insert for distance measurements



Model

- To be attached to the measuring pin
- Ball dia. 4 mm

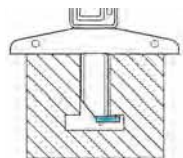

⊗	Order no.	List price EUR
	1271 455	59.00



1376 DIGI-MET® Depth gauge



Example of use

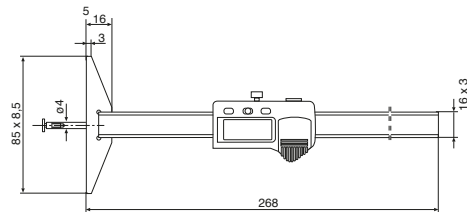
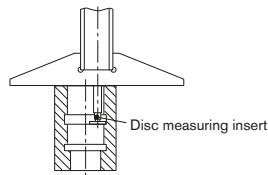
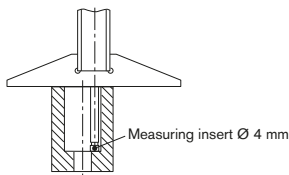

Model

- Stainless steel
- Protection class IP67
- LCD display 7.5 mm
- Locking screw
- Factory standard

Functions

- ON / OFF
- **Quick-Start**
- **Quick-Lock** (key lock)
- Set to zero at any point
- mm / inch switching
- Reversal of counting direction

- PRESET-Function (setting a numerical value)
- Variable data output RS 232 + Digimatic + USB

Delivery

- Wooden case
- Disc type insert Ø 7.5 x 1 mm
- Inserts Ø 4 mm, flat and spherical

Icon	Measuring range		Length of beam	Reading		Error limit	Order no.	List price
	mm	inch	mm	mm	inch	mm		EUR
	0 - 100	0 - 4	85	0.01	.0005	0.02	1376 514	517.00



Accessories

	Order no.	List price EUR
Battery, 3V-Lithium, CR 2032	0220 704	3.90
Disc type measuring insert Ø 7.5 x 0.5 mm	1276 590	33.00
Disc type measuring insert Ø 7.5 x 1 mm	1276 591	18.80
Flat measuring insert Ø 4 mm	1276 592	18.00
Spherical measuring insert Ø 4 mm	1276 593	25.00
Data cable DATA VARIABLE to RS232	1997 501	50.00
Data cable DATA VARIABLE to digimatic	1998 501	64.00
Data cable DATA VARIABLE to USB	1998 720	72.00



1379 DIGI-MET® Depth gauges with interchangeable inserts

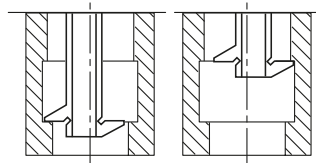
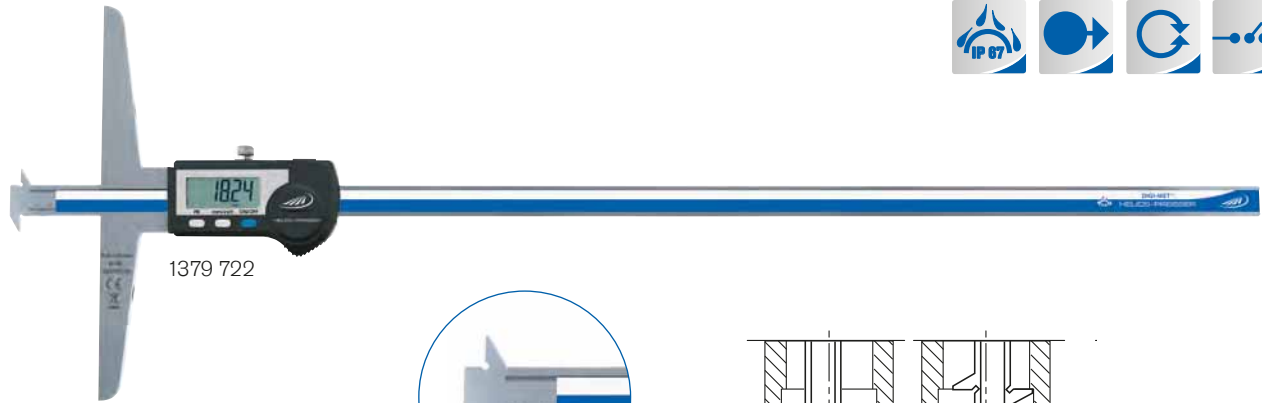

Model

- Interchangeable inserts for solving different measuring tasks
- Measuring base can be attached (optional, see accessories)
- Stainless steel
- Inductive measuring system, protection class IP67
- Factory standard

Functions

- ON / OFF
- **Quick-Start**
- **Quick-Lock** (key lock)
- **PRESET-Function** (setting a numerical value)
- Set to zero at any point
- mm / inch switching
- Variable data output RS 232 + Digimatic + USB

Delivery

- Wooden case
- With inserts for width and distance measurements, Order no. 1279 780
- [More inserts and measuring base optional](#)

Icon	Measuring range		Length of beam mm	Reading		Error limit mm	Order no.	List price EUR
	mm	inch		mm	inch			
▪	0 - 300	0 - 12	150	0.01	.0005	0.03	1379 722	663.00
▪	0 - 500	0 - 20	150	0.01	.0005	0.03	1379 728	914.00



Accessories	Order no.	List price EUR
Interchangeable inserts made of stainless steel, hardened		
Battery, 3V-Lithium, CR 2032	0220 704	3.90
Replacement cylinder screw M2x6	1379 790	8.90
Data cable DATA VARIABLE to RS232	1997 501	50.00
Data cable DATA VARIABLE to digimatic	1998 501	64.00
Data cable DATA VARIABLE to USB	1998 720	72.00



More measuring inserts on page 68



1279 Interchangeable inserts made of stainless steel, hardened



1279 780*

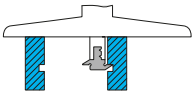
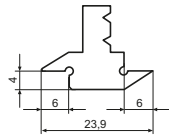

1279 781

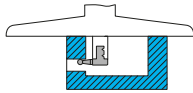
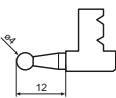

1279 782

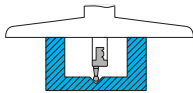

1279 783

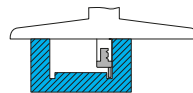

1279 784

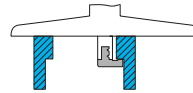

1279 785

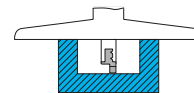
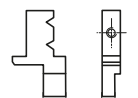

	Description	Order no.	List price EUR
	Insert for width and distance measurements*	1279 780	114.00
	Insert with ball, angled	1279 781	114.00
	Insert with ball, straight	1279 782	114.00
	Insert with measuring pin	1279 783	114.00
	Insert with hook	1279 784	114.00
	Insert with straight measuring rod	1279 785	114.00

* Standard insert included in the delivery of the basic instrument

0279 Sliding measuring base made of stainless steel



Delivery

- Bolts included

	Dimensions mm	Order no.	List price EUR
	300 x 16	0279 722	272.00
	400 x 16	0279 723	284.00
	500 x 16	0279 724	296.00

Accessories

	Order no.	List price EUR
Fixture for sliding measuring base, two parts	0279 792	21.50



1375 DIGI-MET® Small depth gauge



1



Model

- Beam made from stainless steel
- Aluminium body black anodized
- Protection class IP67
- LCD display 7.5 mm
- Factory standard
- Measuring pin Ø 2 mm

Functions

- ON / OFF
- **Quick-Start**
- **Quick-Lock** (key lock)
- Set to zero at any point
- PRESET-Function (setting a numerical value)
- mm / inch switching
- Variable data output RS 232 + Digimatic + USB

Delivery

- Wooden case

Icon	Measuring range		Length of beam	Reading		Error limit	Order no.	List price
	mm	inch	mm	mm	inch	mm		EUR
▶	0 - 25	0 - 1	48	0.01	.0005	0.02	1375 502	249.00



Accessories

	Order no.	List price
		EUR
Battery, 3V-Lithium, CR 2032	0220 704	3.90
Data cable DATA VARIABLE to RS232	1997 501	50.00
Data cable DATA VARIABLE to digimatic	1998 501	64.00
Data cable DATA VARIABLE to USB	1998 720	72.00



1378 DIGI-MET® Depth gauges for one-handed operation



Model

- Stainless steel
- Inductive measuring system, protection class IP67
- Locking screw
- Factory standard
- Constant measuring force through spring pressure
- Measuring pin with thread M 2.5 for exchangeable measuring inserts for core hole bores, also compatible with dial gauges inserts (see No. 0710) for depth measurement

Functions

- ON / OFF
- **Quick-Start**
- **Quick-Lock** (key lock)
- Set to zero at any point
- mm / inch switching
- PRESET-Function (setting a numerical value)
- Variable data output RS 232 + Digimatic + USB

Delivery

- Ball measuring insert for depth measurement

	Measuring range		Reading		Error limit	Order no.	List price
	mm	inch	mm	inch	mm		EUR
	0 - 60	0 - 2.4	0.01	.0005	0.02	1378 505	788.00
	0 - 100	0 - 4	0.01	.0005	0.02	1378 508	848.00

1278 Reduction piece

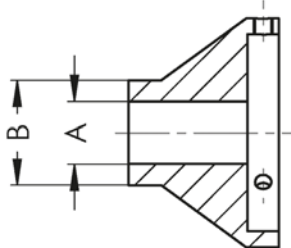

	A	B	Order no.	List price
	mm	mm		EUR
	6	12.00	1278 912	114.00



HELIOS · PREISSER

0273 DIGI-MET® Mounting scales

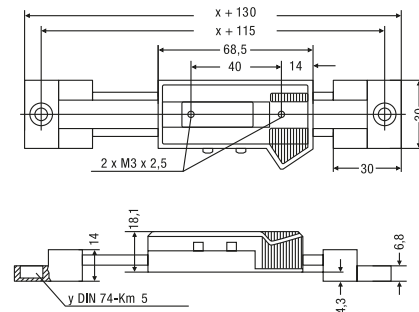
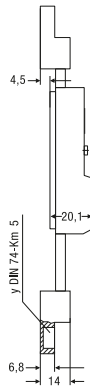
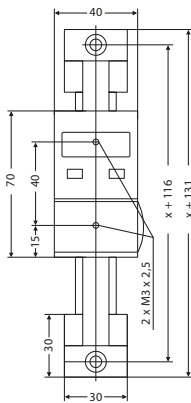

Model

- Beam made of stainless steel
- Slide and fixture are made of anodized aluminium
- Larger measuring ranges are available upon request
- x = Measuring range
- y = Reduction M5

Functions

- ON / OFF
- Set to zero at any point
- mm / inch switching
- Hold
- PRESET-Function (setting a numerical value)

Delivery

- Cardboard box

Icon	Measuring range		Reading		Error limit	Order no.	List price EUR
	mm	inch	mm	inch	mm		
Horizontal							
	0 - 150	0 - 6	0.01	.0005	0.03	0273 731	205.00
	0 - 200	0 - 8	0.01	.0005	0.03	0273 732	212.00
	0 - 300	0 - 12	0.01	.0005	0.03	0273 735	229.00
	0 - 450	0 - 18	0.01	.0005	0.03	0273 738	243.00
	0 - 600	0 - 24	0.01	.0005	0.03	0273 741	295.00
	0 - 800	0 - 31	0.01	.0005	0.04	0273 745	516.00
	0 - 1000	0 - 39	0.01	.0005	0.04	0273 746	562.00
Vertical							
	0 - 150	0 - 6	0.01	.0005	0.03	0273 751	368.00
	0 - 200	0 - 8	0.01	.0005	0.03	0273 752	373.00
	0 - 300	0 - 12	0.01	.0005	0.03	0273 755	396.00
	0 - 450	0 - 18	0.01	.0005	0.03	0273 758	417.00
	0 - 600	0 - 24	0.01	.0005	0.03	0273 761	448.00
	0 - 800	0 - 31	0.01	.0005	0.04	0273 765	629.00
	0 - 1000	0 - 39	0.01	.0005	0.04	0273 766	676.00



Accessories

	Order no.	List price EUR
Battery, 3V-Lithium, CR 2032	0220 704	3.90
Data cable opto to RS232	0996 701	77.00
Data cable opto to USB	0996 705	147.00
USB-keyboard interface cable	0997 770	251.00



0633 Steel gauge block inspection set for calipers



Model

- EN ISO 3650
- Special steel, hardened
- Tolerance class 1
- Supplied with: setting rings 4 mm and 25 mm

Delivery

- Wooden box

Icon	For measuring range mm	Max. nominal size mm	Order no.	List price EUR
3 pieces	200	30.0 / 41.3 / 131.4	0633 833	563.00
4 pieces	300	30.0 / 41.3 / 131.4 / 243.5	0633 834	751.00
6 pieces	500	30.0 / 41.3 / 131.4 / 243.5 / 281.2 / 481.1	0633 836	1341.00
5 pieces	1000	131.4 / 243.5 / 281.2 / 481.1 / 900	0633 838	2371.00



0003 Wooden cases for calipers



0003 217



0003 231



0003 248

Measuring range mm	Jaw length (knife points) mm	Jaw length (w.o. knife points) mm	Internal dimensions L x W x H mm	Order no.	List price EUR
With recess for pocket caliper 150 mm					
160	40	40	250 x 90 x 20	0003 217	7.70
With flat foam inlay					
160	40	40	250 x 90 x 20	0003 219	7.70
200	80	80	315 x 145 x 20	0003 220	9.20
250	80	80	370 x 145 x 20	0003 221	11.60
300	90	90	435 x 175 x 20	0003 222	16.00
300		150	435 x 205 x 20	0003 223	17.90
400		125	610 x 180 x 20	0003 224	27.00
400	125	150	590 x 220 x 20	0003 225	35.10
400	150	200	590 x 250 x 20	0003 226	41.90
500		150	690 x 200 x 20	0003 228	46.70
500	150	200	690 x 250 x 25	0003 229	47.90
500	200	250	700 x 315 x 25	0003 230	49.20
500	250		700 x 350 x 21	0003 231	50.00
600		150	790 x 200 x 25	0003 232	50.00
600	150	200	790 x 250 x 25	0003 233	60.00
600		300	810 x 400 x 25	0003 235	73.00
800		150	1000 x 220 x 25	0003 236	61.00
800	150	200	1000 x 270 x 25	0003 237	66.00
800	200		1000 x 320 x 21	0003 238	67.00
800		300	1000 x 380 x 25	0003 239	75.00
800	300		1000 x 420 x 21	0003 240	86.00
800		400	1100 x 480 x 25	0003 241	86.00
1000		150	1200 x 220 x 25	0003 242	82.00
1000	150	200	1250 x 270 x 25	0003 243	88.00
1000	200		1200 x 320 x 21	0003 244	99.00
1000		300	1200 x 380 x 25	0003 245	109.00
1000	300		1230 x 420 x 21	0003 246	118.00
1000		500	1300 x 600 x 25	0003 247	135.00
▪ 1250		200	1520 x 310 x 25	0003 248	115.00
▪ 1250	200	300	1520 x 380 x 25	0003 249	115.00
▪ 1500		200	1800 x 310 x 25	0003 251	152.00
▪ 1500	200	300	1800 x 380 x 25	0003 252	165.00
▪ 1500	300		1800 x 440 x 25	0003 253	196.00
▪ 2000		200	2300 x 310 x 25	0003 254	255.00
▪ 2000	200	300	2300 x 380 x 25	0003 255	301.00
▪ 2000	300		2300 x 460 x 25	0003 256	284.00
▪ 3000		200	3310 x 310 x 25	0003 257	306.00
▪ 3000	200	300	3310 x 400 x 25	0003 258	318.00
▪ 3000	300		3310 x 460 x 25	0003 259	368.00



SAMPLES MICROMETERS

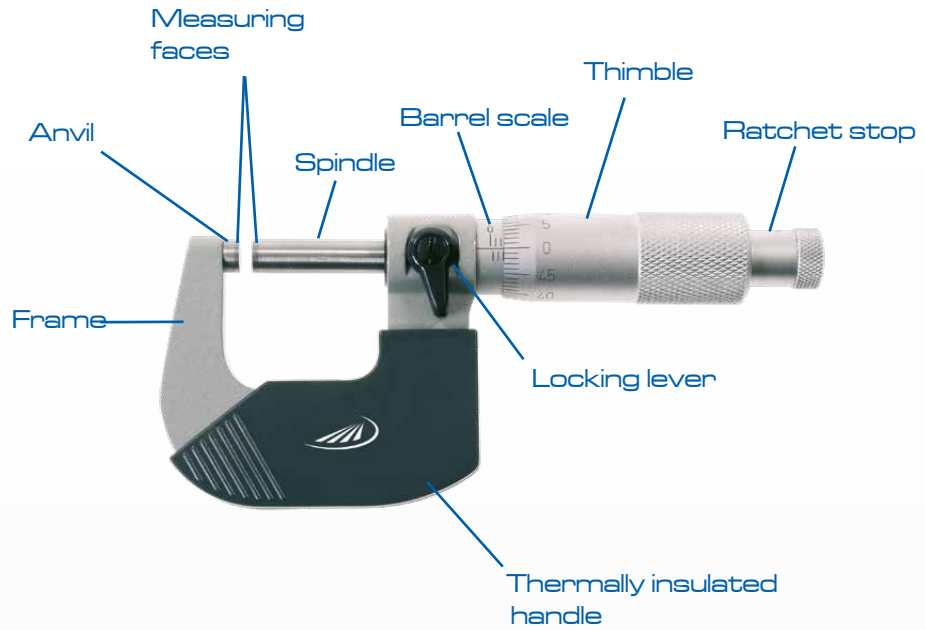

Micrometer highlights from our assortment



INTERNAL MICROMETERS



SPECIAL MICROMETERS



HOLDER & SETTING STANDARDS

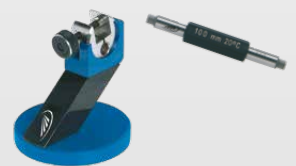

2. CHAPTER MICROMETERS

76	External micrometers
83	Digital external micrometers
88	Precision dial micrometers
89	External micrometers with special measuring faces
91	Setting standards for micrometers
92	External micrometers for thread flank measurement
95	External micrometers for gear tooth measurements
96	Wire micrometer
97	Internal micrometers
102	Digital 3 point internal micrometers
104	Digital internal micrometers / with measuring pistol
106	Measuring heads and extensions
107	Depth micrometers



0800 External micrometers



0800 501

**DIN
863-1**

Model

- DIN 863-1
- Reading: 0.01 mm
- Reading parts are satin chrome finished
- Locking lever
- Ratchet stop
- Carbide measuring faces
- Thermally insulated

Delivery

- Plastic case
- From measuring range 25 - 50 mm upwards includes a setting standard

✕	⚙	Measuring range mm	Pitch mm	Spindle dia. mm	Thimble dia. mm	Error limit mm	Order no.	List price EUR
		0 - 25	0.5	6.5	17	0.004	0800 501	18.90
		25 - 50	0.5	6.5	17	0.004	0800 502	22.90
		50 - 75	0.5	6.5	17	0.005	0800 503	26.30
		75 - 100	0.5	6.5	17	0.005	0800 504	31.10

0800 Set of external micrometers



Delivery

- Includes 4 external micrometers
- Incl. setting gauges 25/50/75 mm
- Wooden case

**DIN
863-1**

✕	⚙	Measuring range mm	Pitch mm	Spindle dia. mm	Thimble dia. mm	Order no.	List price EUR
		0 - 100	0.5	6.5	17	0800 513	110.00

0807 Holder for external micrometers



Model

- With heavy cast iron base
- Vertically rotating and lockable

Delivery

- Cardboard box

✕	⚙	Measuring range mm	Order no.	List price EUR
		0 - 300	0807 101	56.00



0806 External micrometers with friction clutch



DIN
863-1



0806 501

Model

- DIN 863-1
- Reading: 0.01 mm
- Reading parts are satin chrome finished
- Locking lever
- With friction clutch (ratchet)
- Fixed quick drive
- Carbide measuring faces
- Thermally insulated

Delivery

- Plastic case
- From measuring range 25 - 50 mm upwards includes a setting gauge

⌘	⌘	Measuring range mm	Pitch mm	Spindle dia. mm	Thimble dia. mm	Error limit mm	Order no.	List price EUR
		0 - 25	0.5	6.5	18	0.004	0806 501	34.10
		25 - 50	0.5	6.5	18	0.004	0806 502	37.30
		50 - 75	0.5	6.5	18	0.005	0806 503	40.60
		75 - 100	0.5	6.5	18	0.005	0806 504	43.90

2

0806 Set of external micrometers with friction clutch



DIN
863-1



0806 513

Delivery

- Includes 4 external micrometers
- Incl. setting gauges 25/50/75 mm
- Wooden case

⌘	⌘	Measuring range mm	Pitch mm	Spindle dia. mm	Thimble dia. mm	Error limit mm	Order no.	List price EUR
		0 - 100	0.5	6.5	18	0.005	0806 513	160.00



0806 External micrometers



DIN
863-1



Model

- DIN 863-1
- Reading 0.01 mm
- Reading parts are satin chrome finished
- Locking lever
- Ratchet stop
- Carbide measuring faces
- Thermally insulated
- Coated steel frame

Delivery

- Plastic case
- From measuring range 25 - 50 mm upwards includes a setting standard

✕	¼	Measuring range mm	Pitch mm	Spindle dia. mm	Thimble dia. mm	Error limit mm	Order no.	List price EUR
		0 - 25	0.5	6.5	17.5	0.004	0806 521	46.00
		25 - 50	0.5	6.5	17.5	0.004	0806 522	74.00
		50 - 75	0.5	6.5	17.5	0.005	0806 523	91.00
		75 - 100	0.5	6.5	17.5	0.005	0806 524	105.00
		100 - 125	0.5	6.5	17.5	0.006	0806 525	143.00
		125 - 150	0.5	6.5	17.5	0.006	0806 526	160.00
		150 - 175	0.5	6.5	17.5	0.007	0806 527	178.00
		175 - 200	0.5	6.5	17.5	0.007	0806 528	196.00

0806 Set of external micrometers



DIN
863-1



Delivery

- Includes 4 external micrometers
- Incl. setting gauges 25 + 75 mm or 125 + 175 mm
- Wooden case

✕	¼	Measuring range mm	Pitch mm	Spindle dia. mm	Thimble dia. mm	Order no.	List price EUR
		0 - 100	0.5	6.5	17.5	0806 540	275.00
		100 - 200	0.5	6.5	17.5	0806 542	605.00



0810 External micrometers



DIN
863-1



0810 504

Model

- DIN 863-1
- Reading: 0.01 mm
- Reading parts are satin chrome finished
- Locking ring
- Spheroid ductile iron frame, lacquered
- Ratchet stop
- Carbide measuring faces
- Thermally insulated

Delivery

- Wooden case

2

⌘	⌘	Measuring range mm	Pitch mm	Spindle dia. mm	Thimble dia. mm	Error limit mm	Order no.	List price EUR
		0 - 25	1	8	30	0.004	0810 501	276.00
		25 - 50	1	8	30	0.004	0810 502	292.00
		50 - 75	1	8	30	0.005	0810 503	307.00
		75 - 100	1	8	30	0.005	0810 504	325.00

0815 External micrometers with deep frame



DIN
863-1



0815 530

Model

- DIN 863-1
- Reading: 0.01 mm
- Reading parts are satin chrome finished
- Steel bracket lacquered
- Ratchet stop
- Carbide measuring faces
- Wooden case

Delivery

⌘	⌘	Measuring range mm	Frame depth mm	Pitch mm	Spindle dia. mm	Thimble dia. mm	Error limit mm	Order no.	List price EUR
		0 - 25	100	1	8	24	0.004	0815 510	291.00
		0 - 25	150	1	6.5	24	0.004	0815 514	307.00
		0 - 25	250	1	6.5	24	0.004	0815 518	383.00
		0 - 50	50	1	8	24	0.004	0815 530	330.00
		0 - 50	100	1	8	24	0.004	0815 534	487.00
		50 - 100	100	1	8	24	0.005	0815 540	538.00



0816 External micrometers large spindle distance 50 mm



**DIN
863-1**



Model

- DIN 863-1
- Direct reading 0.01 mm, without addition because of thread pitch 1 mm
- Reading parts are satin chrome finished
- Locking ring
- Ratchet stop
- Carbide measuring faces
- Thermally insulated
- With 50 mm spindle movement and a wide measuring range
- Spheroid ductile iron frame, lacquered or coated light alloy frame

Delivery

- Wooden case

✂	⚙	Measuring range mm	Pitch mm	Spindle dia. mm	Thimble dia. mm	Error limit mm	Order no.	List price EUR
		0 - 50	1	8	24	0.004	0816 501	348.00
		50 - 100	1	8	24	0.005	0816 502	393.00
		100 - 150	1	8	24	0.006	0816 503	453.00
		150 - 200	1	8	24	0.007	0816 504	517.00
		200 - 250	1	8	24	0.008	0816 505	589.00
		250 - 300	1	8	24	0.009	0816 506	664.00
		300 - 350	1	10	24	0.01	0816 507	938.00
		350 - 400	1	10	24	0.011	0816 508	991.00
		400 - 450	1	10	24	0.012	0816 509	1053.00
		450 - 500	1	10	24	0.013	0816 510	1130.00
		500 - 550	1	10	24	0.015	0816 511	1219.00
		550 - 600	1	10	24	0.017	0816 512	1304.00



0817 External micrometers with wide range of applications 100 mm



DIN
863-3



2

Model

- DIN 863-3
- Direct reading 0.01 mm, without addition because of thread pitch 1 mm
- Reading parts are satin chrome finished
- Spindle adjustment 50 mm
- Reversible anvil (screwed) for measuring range extension
- Locking ring
- Ratchet stop
- Carbide measuring faces
- Thermally insulated
- Robust coated light alloy frame

Delivery

- Wooden case

⏏	⚙	Measuring range mm	Pitch mm	Spindle dia. mm	Thimble dia. mm	Error limit mm	Order no.	List price EUR
		200 - 300	1	10	24	0.006	0817 512	1120.00
		300 - 400	1	10	24	0.007	0817 514	1165.00
		400 - 500	1	10	24	0.008	0817 516	1304.00
		500 - 600	1	10	24	0.009	0817 518	1480.00
		600 - 700	1	10	24	0.009	0817 520	1655.00
	▪	700 - 800	1	10	24	0.009	0817 522	1836.00
	▪	800 - 900	1	10	24	0.01	0817 524	2021.00
	▪	900 - 1000	1	10	24	0.01	0817 526	2236.00



0819 External micrometers with interchangeable inserts

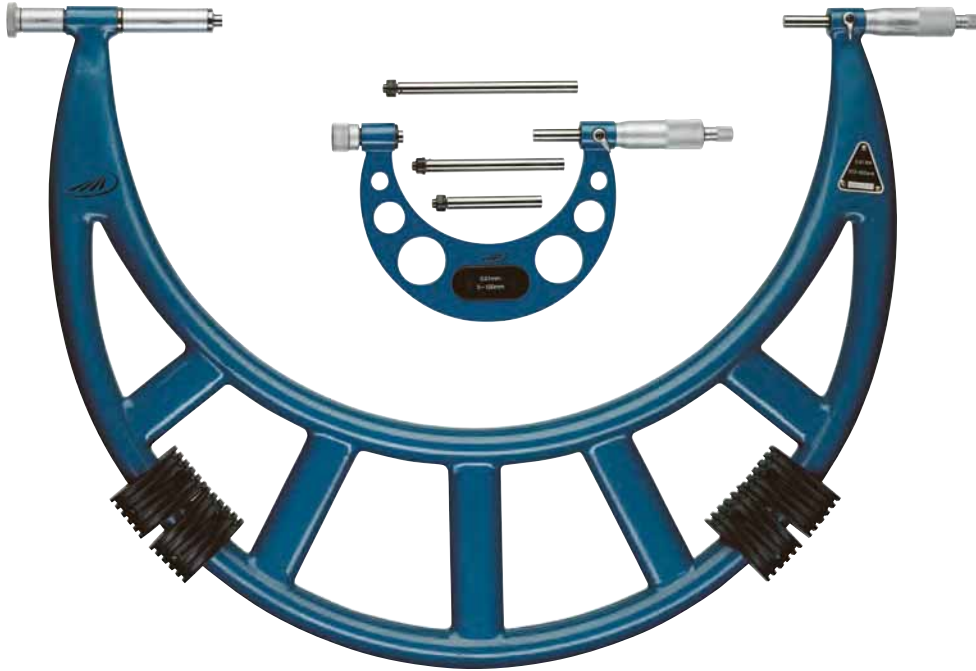

Model

- Reading: 0.01 mm
- Reading parts are satin chrome finished
- Locking lever
- Ratchet stop
- Carbide measuring faces
- Thermally insulated
- Coated malleable cast iron frame* or coated light alloy frame with interchangeable anvil

Delivery

- Wooden case
- Includes setting standards

✕	¼	Measuring range mm	Pitch mm	Spindle dia. mm	Thimble dia. mm	Order no.	List price EUR
		0 - 100	0.5	8	20	0819 501	184.00
		0 - 150	0.5	8	20	0819 502	205.00
		100 - 200	0.5	8	20	0819 503	227.00
		150 - 300	0.5	8	20	0819 505	259.00
		200 - 300	0.5	8	20	0819 510	249.00
		300 - 400	0.5	8	24	0819 511	314.00
		400 - 500	0.5	8	24	0819 512	357.00
		500 - 600	0.5	8	24	0819 513	412.00
		600 - 700	0.5	8	24	0819 514	508.00
	▪	700 - 800	0.5	8	24	0819 515	585.00
	▪	800 - 900	0.5	8	24	0819 516	671.00
	▪	900 - 1000	0.5	8	24	0819 517	758.00
	▪	1000 - 1200	1	8	30	0819 519	1408.00
	▪	1200 - 1400	1	8	30	0819 521	1516.00
	▪	1400 - 1600	1	8	30	0819 523	1786.00
	▪	1600 - 1800	1	8	30	0819 525	2052.00
	▪	1800 - 2000	1	8	30	0819 527	2360.00



0912 Digital micrometers IP54



2

Model

- Protection class IP54
- Reading: 0.001 mm / .00005 inch
- Locking lever
- Ratchet stop
- Carbide measuring faces
- Thermally insulated
- Factory standard

Functions

- ON / OFF
- mm / inch switching
- Set to zero at any point

Delivery

- Plastic case
- From measuring range 25 mm upwards includes a setting standard

Icon	Measuring range		Pitch	Spindle dia.	Error limit	Order no.	List price
	mm	inch					
	0 - 25	0 - 1	0.5	6.5	0.006	0912 501	81.00
	25 - 50	1 - 2	0.5	6.5	0.006	0912 502	92.00
	50 - 75	2 - 3	0.5	6.5	0.007	0912 503	105.00
	75 - 100	3 - 4	0.5	6.5	0.007	0912 504	120.00
	100 - 125	4 - 5	0.5	6.5	0.008	0912 505	132.00
	125 - 150	5 - 6	0.5	6.5	0.008	0912 506	145.00
	150 - 175	6 - 7	0.5	6.5	0.009	0912 507	156.00
	175 - 200	7 - 8	0.5	6.5	0.009	0912 508	168.00

Accessories	Order no.	List price
		EUR
Battery 1.5V, type 357	0220 204	3.30

0912 Set of digital micrometers



Delivery

- Includes 4 micrometers
- Incl. setting gauges 25/50/75 mm
- Wooden case

Icon	Measuring range	Pitch	Spindle dia.	Order no.	List price
	mm	mm	mm		EUR
	0 - 100	0.5	6.5	0912 521	435.00



1866 Digital micrometers IP65



1866 410



1866 510



Model

- Reading: 0.001 mm / .00005 inch
- Protection class IP65
- LCD display: 10 mm
- Rapid drive
- Carbide measuring faces
- Spindle stainless, hardened and smoothed
- Frame lacquered
- Thermally insulated
- Factory standard

Functions

- ON / OFF
- **Quick-Start**
- **Quick-Lock** (key lock)
- Set to zero at any point
- mm / inch switching
- ABS (display can be set to zero without losing the ORIGIN)
- Hold

▪ Additionally 1866 5xx:

- ORIGIN (Preset value)
- Variable data output USB + Digimatic
- TOL (tolerance value input)

Delivery

- Plastic case
- From measuring range 25 mm upwards includes a setting standard

✕	📏	Measuring range		Pitch mm	Spindle dia. mm	Error limit mm	Order no.	List price EUR
		mm	inch					
Without data output								
		0 - 25	0 - 1	0.5	6.5	0.002	1866 410	207.00
		25 - 50	1 - 2	0.5	6.5	0.002	1866 413	270.00
		50 - 75	2 - 3	0.5	6.5	0.003	1866 417	343.00
		75 - 100	3 - 4	0.5	6.5	0.003	1866 420	391.00
With DataVariable bidirectional								
		0 - 25	0 - 1	0.5	6.5	0.002	1866 510	249.00
		25 - 50	1 - 2	0.5	6.5	0.002	1866 513	299.00
		50 - 75	2 - 3	0.5	6.5	0.003	1866 517	389.00
		75 - 100	3 - 4	0.5	6.5	0.003	1866 520	435.00



1998725

1998802

Accessories

	Order no.	List price EUR
Battery, 3V-Lithium, CR 2032	0220 704	3.90
Data cable bidirectional DataVariable to USB	1998 801	98.00
Data cable bidirectional DataVariable to Digimatic	1998 802	85.00



HELIOS • PREISSER

1866i Digital micrometers IP65 with integrated wireless



1866 41060



**integrated
iw wireless**
Wireless Data Transmission

2

Model

- Reading: 0.001 mm / .00005 inch
- Protection class IP65
- LCD display: 10 mm
- Rapid drive
- Carbide measuring faces
- Spindle stainless, hardened and smoothed
- Frame lacquered
- Thermally insulated
- Factory standard

Functions

- ON / OFF
- **Quick-Start**
- **Quick-Lock** (key lock)
- Set to zero at any point
- mm / inch switching
- ABS (display can be set to zero without losing the ORIGIN)
- Hold
- ORIGIN (Preset value)
- TOL (tolerance value input)
- Integrated Wireless

Delivery

- Plastic case
- From measuring range 25 mm upwards includes a setting standard

Measuring range	Measuring range		Pitch	Spindle dia.	Error limit	Order no.	List price
	mm	inch					
0 - 25	0 - 1	0.5	6.5	0.002	1866 41060	259.00	
25 - 50	1 - 2	0.5	6.5	0.002	1866 41360	319.00	
50 - 75	2 - 3	0.5	6.5	0.003	1866 41760	389.00	
75 - 100	3 - 4	0.5	6.5	0.003	1866 42060	435.00	

Accessories

	Order no.	List price
		EUR
Battery, 3V-Lithium, CR 2032	0220 704	3.90
i-Stick USB-receiver for Integrated Wireless	1998 780	95.00



1998780

More information on our i-series and Integrated Wireless on page 252

Integrated Wireless is intended to be sold within the European Economic Area only



1866i Digital micrometers IP65 linear 5 mm pitch



Specification

- Reading: 0,001 mm / .00005 inch
- Protection class IP65
- LCD display: 10 mm
- **Rapid drive**
- Sliding spindle
- Carbide measuring faces
- Spindle stainless, hardened and smoothed
- Frame lacquered
- Thermally insulated
- Factory standard

Functions

- ON / OFF
- **Quick-Start**
- **Quick-Lock** (key lock)
- Set to zero at any point
- mm / inch switching
- ABS (display can be set to zero without losing the ORIGIN)
- ORIGIN (Preset value)
- Hold
- TOL (tolerance value input)

- Variable data output (1866) USB + Digimatic
- Integrated Wireless (1866i)

Delivery

- Plastic case
- From measuring range 25 mm upwards includes a setting standard

✕	📏	Measuring range		Pitch mm	Spindle dia. mm	Error limit mm	Order no.	List price EUR
		mm	inch					
With DataVariable bidirectional								
		0 - 25	0 - 1	5	6.5	0.002	1866 610	339.00
		25 - 50	1 - 2	5	6.5	0.002	1866 613	389.00
		50 - 75	2 - 3	5	6.5	0.003	1866 617	489.00
		75 - 100	3 - 4	5	6.5	0.003	1866 620	529.00
With Integrated Wireless								
		0 - 25	0 - 1	5	6.5	0.002	186661 060	349.00
		25 - 50	1 - 2	5	6.5	0.002	186661 360	399.00
		50 - 75	2 - 3	5	6.5	0.003	186661 760	499.00
		75 - 100	3 - 4	5	6.5	0.003	186662 060	539.00

Integrated Wireless is intended to be sold within the European Economic Area only

Accessories



	Order no.	List price EUR
Battery, 3V-Lithium, CR 2032	0220 704	3.90
Data cable bidirectional DataVariable to USB	1998 801	98.00
Data cable bidirectional DataVariable to Digimatic	1998 802	85.00
i-Stick USB-receiver for Integrated Wireless	1998 780	95.00



1866 Digital micrometer BASIC



Model

- Reading: 0.001 mm / .00005 inch
- Protection class IP40
- LCD display: 10 mm
- Rapid drive
- Carbide measuring faces
- Spindle stainless, hardened and smoothed
- Frame lacquered
- Thermally insulated
- Factory standard

Functions

- ON / OFF
- **Quick-Start**
- **Quick-Lock** (key lock)
- Set to zero at any point
- mm / inch switching
- Hold

Delivery

- Plastic case

Icon	Measuring range		Pitch mm	Spindle dia. mm	Error limit mm	Order no.	List price EUR
	mm	inch					
	0 - 25	0 - 1	0.5	6.5	0.002	1866 210	175.00

Accessories

Battery, 3V-Lithium, CR 2032

Order no.

0220 704

List price

EUR
3.90

1866i Sets of digital micrometers



Delivery

- Plastic case
- From measuring range 25 mm upwards includes a setting standard

Icon	Measuring range		Spindle dia. mm	Order no.	List price EUR
	mm	inch			
With Integrated Wireless					
	0 - 100	0 - 4	6.5	1866 42160	1390.00
With DataVariable bidirectional					
	0 - 100	0 - 4	6.5	1866 521	1360.00

Accessories

Battery, 3V-Lithium, CR 2032

Order no.

0220 704

List price

EUR

Data cable bidirectional DataVariable to USB

1998 801

98.00

Data cable bidirectional DataVariable to Digimatic

1998 802

85.00

i-Stick USB-receiver for Integrated Wireless

1998 780

95.00



0849 Precision dial micrometers



DIN
863-3



0849 501

Model

- DIN 863-3
- Reading: 0.01 mm
- Reading on the dial: 1 μm
- Reading parts are satin chrome finished
- Retraction stroke 1.5 mm

- Spindle made of hardened stainless steel
- Constant measuring force
- Locking lever
- Carbide measuring faces
- Thermally insulated

Delivery

- Wooden case

∇	$\frac{\%}{\text{mm}}$	Measuring range mm	Pitch mm	Spindle dia. mm	Thimble dia. mm	Order no.	List price EUR
		0 - 25	0.5	7.5	17.5	0849 501	737.00
		25 - 50	0.5	7.5	17.5	0849 502	876.00

0850 Precision dial micrometers



DIN
863-3



0850 511

Model

- DIN 863-3
- Reading: 0.01 mm
- Reading on the dial: 1 μm
- Reading parts are satin chrome finished
- Retraction stroke 1.2 mm

- Locking lever
- Carbide measuring faces
- Constant measuring force
- Thermally insulated
- Spindle made of hardened stainless steel

- Adjustable tolerance markers

Delivery

- Wooden case
- Incl. dial comparator gauge

∇	$\frac{\%}{\text{mm}}$	Measuring range mm	Pitch mm	Spindle dia. mm	Thimble dia. mm	Order no.	List price EUR
		0 - 25	0.5	7.5	17.5	0850 511	582.00
		25 - 50	0.5	7.5	17.5	0850 512	646.00
		50 - 100	0.5	7.5	17.5	0850 514	687.00
		100 - 150	0.5	7.5	17.5	0850 516	734.00
		150 - 200	0.5	7.5	17.5	0850 518	768.00



0822 Disc micrometers



Model

- Factory standard
- Reading: 0.01 mm
- Carbide measuring faces
- Ratchet stop
- Disc dia. 60 mm
- Malleable cast iron frame, lacquered

Delivery

- Wooden case

Measuring range mm	Pitch mm	Spindle dia. mm	Thimble dia. mm	Order no.	List price EUR
Frame depth 50 mm					
0 - 15	1	6.5	20	0822 301	95.00
0 - 25	1	6.5	20	0822 302	144.00
0 - 50	1	6.5	20	0822 303	265.00
Frame depth 100 mm					
0 - 50	1	6.5	20	0822 304	433.00

0824 Micrometers for tube wall measurement



DIN
863-3

Model

- DIN 863-3
- Reading: 0.01 mm
- Reading parts are satin chrome finished
- Ratchet stop
- Hardened measuring faces

- Malleable cast iron frame, lacquered

Delivery

- Cardboard box

Measuring range mm	Pitch mm	Spindle dia. mm	Thimble dia. mm	Error limit mm	Order no.	List price EUR
Ball dia. 2.5 mm						
0 - 15	0.5	6.5	20	0.001	0824 302	194.00
Ball dia. 6.5 mm						
0 - 25	0.5	6.5	20	0.001	0824 303	196.00



0854 Blade micrometers



**DIN
863-3**



Model

- DIN 863-3
- Reading: 0.01 mm
- Reading parts are satin chrome finished
- Ratchet stop
- Thermally insulated
- Hardened spindle and anvil
- Coated steel frame

Delivery

- Plastic case
- From measuring range 25 - 50 mm upwards includes a setting standard

✕	¼	Measuring range mm	Pitch mm	Spindle dia. mm	Thimble dia. mm	Error limit mm	Order no.	List price EUR
Measuring faces dia. 0.8 x 7 mm								
		0 - 25	0.5	8	17.5	0.004	0854 301	257.00
		25 - 50	0.5	8	17.5	0.004	0854 302	312.00
		50 - 75	0.5	8	17.5	0.005	0854 303	334.00
		75 - 100	0.5	8	17.5	0.005	0854 304	363.00

0855 Micrometers with reduced measuring faces



**DIN
863-3**



Model

- DIN 863-3
- Reading: 0.01 mm
- Reading parts are satin chrome finished
- Locking lever
- Ratchet stop
- Carbide measuring faces
- Thermally insulated
- Hardened spindle and anvil
- Coated steel frame

Delivery

- Plastic case
- From measuring range 25 - 50 mm upwards includes a setting standard

✕	¼	Measuring range mm	Pitch mm	Spindle dia. mm	Thimble dia. mm	Error limit mm	Order no.	List price EUR
Measuring surfaces dia. 3 mm, length 8.5 mm								
		0 - 25	0.5	6.5	17.5	0.004	0855 301	185.00
		25 - 50	0.5	6.5	17.5	0.004	0855 302	227.00
		50 - 75	0.5	6.5	17.5	0.005	0855 303	257.00
		75 - 100	0.5	6.5	17.5	0.005	0855 304	272.00



0898 Settings gauges for micrometers



0898 104

Model

- Rod
- Special steel, aged
- Hardened measuring faces
- Tolerance zone js2
- Thermally insulated
- Parallel lapped measuring faces

⊗	¼	Measuring range mm	Measuring surface dia. mm	Order no.	List price EUR
		25	6.5	0898 101	11.40
		50	6.5	0898 102	19.10
		75	6.5	0898 103	22.60
		100	6.5	0898 104	25.80
		125	6.5	0898 105	29.90
		150	6.5	0898 106	42.30
		175	6.5	0898 107	47.30
		200	6.5	0898 108	52.00
		225	6.5	0898 109	57.00
		250	6.5	0898 110	63.00
		275	6.5	0898 111	67.00
		300	10	0898 112	83.00
		325	10	0898 113	90.00
		350	10	0898 114	96.00
		375	10	0898 115	102.00
		400	10	0898 116	109.00
		425	10	0898 117	116.00
		450	10	0898 118	122.00
		475	10	0898 119	128.00

⊗	¼	Measuring range mm	Measuring surface dia. mm	Order no.	List price EUR
		500	10	0898 120	135.00
		525	10	0898 121	142.00
		550	10	0898 122	149.00
		575	10	0898 123	156.00
		600	10	0898 124	164.00
		625	10	0898 125	171.00
		650	10	0898 126	177.00
		675	10	0898 127	184.00
		700	10	0898 128	192.00
		800	10	0898 132	221.00
		900	10	0898 136	249.00
		1000	10	0898 140	277.00
	▪	1050	10	0898 142	290.00
	▪	1150	10	0898 146	318.00
	▪	1250	10	0898 150	349.00
	▪	1350	10	0898 154	376.00
	▪	1450	10	0898 158	405.00
	▪	1550	10	0898 162	649.00



0870 Precision micrometers for thread flank measurement



DIN
863-3



Model

- DIN 863-3
- Reading 0.01 mm
- Reading parts are satin chrome finished
- Locking ring
- Ratchet stop
- Thermally insulated
- Spheroid ductile iron frame, lacquered

Delivery

- Wooden case
- **Thread flank inserts and setting standards must be ordered separately**

✕	📏	Measuring range	Pitch	Thimble dia.	Error limit	Spindle adjustment	Required length of setting standard	Order no.	List price
		mm	mm	mm	mm	mm	mm		EUR
For inserts with shank dimensions, dia. 3.5 x 13.5 mm									
		0 - 25	0.5	20	0.004	25	-	0870 301	328.00
		25 - 50	0.5	20	0.004	25	25	0870 302	343.00
		50 - 75	0.5	20	0.005	25	50	0870 303	369.00
		75 - 100	0.5	20	0.005	25	75	0870 304	403.00
		100 - 125	0.5	20	0.006	25	100	0870 305	442.00
		125 - 150	0.5	20	0.006	25	125	0870 306	480.00
		150 - 200	0.5	20	0.007	50	175	0870 307	685.00
		200 - 250	0.5	20	0.008	50	225	0870 309	748.00
		250 - 300	0.5	20	0.009	50	275	0870 311	823.00



0870 Thread flank inserts for external measurement

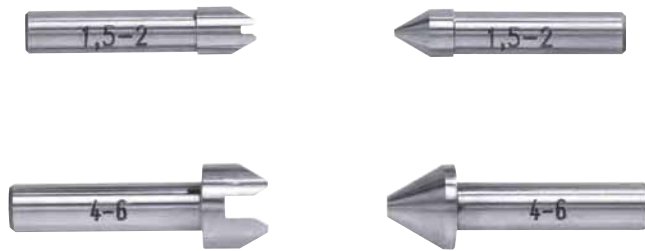

Model

- Made of hardened special steel and finely grinded
- Every insert is inscribed with the pitch details
- In a set (V-anvil + tapered anvil)
- Shank dimensions: 3.5 x 13.5 mm

⏪	🏠	Pitch angle in degrees	Pitch mm	Applicable for UNC, UNF 60°	Thread pitch in TPI mm	Order no.	List price EUR
Metric ISO - threads							
		60°	0.35 - 0.50	72 - 48		0870 901	124.00
		60°	0.60 - 0.80	44 - 32		0870 903	107.00
		60°	0.90 - 1.25	28 - 18		0870 905	107.00
		60°	1.5 - 2.0	16 - 11		0870 907	107.00
		60°	2.5 - 3.5	10 - 7		0870 909	107.00
		60°	4.0 - 6.0	6 - 4		0870 911	124.00
Whitworth - threads							
		55°			60 - 48	0870 921	135.00
		55°			40 - 32	0870 923	117.00
		55°			28 - 22	0870 925	117.00
		55°			20 - 16	0870 927	117.00
		55°			14 - 11	0870 929	117.00
		55°			10 - 7	0870 931	117.00
		55°			6 - 4	0870 933	135.00
Metric ISO - Trapezoid threads (DIN 103)							
		30°	1.5			0870 941	318.00
		30°	2.0			0870 943	231.00
		30°	3.0			0870 945	203.00
		30°	4.0			0870 947	203.00
		30°	5.0 - 6.0			0870 949	203.00
		30°	7.0 - 8.0			0870 951	203.00
		30°	9.0 - 10.0			0870 953	231.00
		30°	12.0 - 14.0			0870 955	318.00





0870 Thread flank setting gauges for external measurement



Model

- Measuring faces made of hardened special steel
- One end is rounded, the lapped bore simplifies the fitting upon the conical insert
- Thermally insulated handle
- **Note: With trapezoid treads every pitch requires a separate setting standard**

		Length mm	Pitch angle in degrees	Available for following pitches mm	Error limit µm	Order no.	List price EUR
Metric ISO - threads							
		25	60°		3	0870 801	78.00
		50	60°		3	0870 802	79.00
		75	60°		3	0870 803	80.00
		100	60°		4	0870 804	81.00
		125	60°		4	0870 805	82.00
		175	60°		4	0870 807	91.00
		225	60°		4	0870 809	103.00
		275	60°		4	0870 811	113.00
Whitworth - threads							
		25	55°		3	0870 821	78.00
		50	55°		3	0870 822	79.00
		75	55°		3	0870 823	80.00
		100	55°		4	0870 824	86.00
		125	55°		4	0870 825	87.00
		175	55°		4	0870 827	100.00
		225	55°		4	0870 829	114.00
		275	55°		4	0870 831	131.00
Metric ISO - Trapezoid threads (DIN 103)*							
		25	30°	2 / 3 / 4 / 5 - 6 / 7 - 8 / 9 - 10	4	0870 841	170.00
		50	30°	2 / 3 / 4 / 5 - 6 / 7 - 8 / 9 - 10	4	0870 842	175.00
		75	30°	2 / 3 / 4 / 5 - 6 / 7 - 8 / 9 - 10	4	0870 843	180.00
		100	30°	3 / 4 / 5 - 6 / 7 - 8 / 9 - 10 / 12 - 14	5	0870 844	187.00
		125	30°	4 / 5 - 6 / 7 - 8 / 9 - 10 / 12 - 14	5	0870 845	203.00
		175	30°	4 / 5 - 6 / 7 - 8 / 9 - 10 / 12 - 14	5	0870 847	242.00
		225	30°	5 - 6 / 7 - 8 / 9 - 10 / 12 - 14	5	0870 849	295.00
		275	30°	5 - 6 / 7 - 8 / 9 - 10 / 12 - 14	5	0870 851	362.00

* When ordering the respective pitch must be specified



0864 Disc micrometers to measure gear tooth



DIN 863-3

Model

- DIN 863-3
- Reading: 0.01 mm
- Reading parts are satin chrome finished
- Modul 0.8 - 6
- Ratchet stop
- Hardened measuring faces
- Locking ring
- Friction coupling
- Thermally insulated

Delivery

- Wooden case

⌘	⌘	Measuring range mm	Disc dia. mm	Pitch mm	Thimble dia. mm	Error limit mm	Order no.	List price EUR
		0 - 25	25	0.5	20	0.004	0864 321	330.00
		25 - 50	25	0.5	20	0.004	0864 322	396.00
		50 - 75	25	0.5	20	0.005	0864 323	429.00
		75 - 100	25	0.5	20	0.005	0864 324	466.00
		100 - 125	25	0.5	20	0.006	0864 325	503.00
		125 - 150	25	0.5	20	0.006	0864 326	539.00
		150 - 175	25	0.5	20	0.007	0864 327	579.00
		175 - 200	25	0.5	20	0.007	0864 328	619.00

2

0890 Wire thickness micrometer



Model

- Factory standard
- Reading: 0.01 mm
- Readings parts are satin chrome finished
- Ratchet stop
- Carbide measuring faces

Delivery

- Cardboard box

⌘	⌘	Measuring range mm	Pitch mm	Spindle dia. mm	Thimble dia. mm	Order no.	List price EUR
		0 - 10	0.5	6	18	0890 511	69.00



0884 Internal micrometer with measuring jaws



Model

DIN
863-4

- DIN 863-4
- Reading: 0.01 mm
- Reading parts are satin chrome finished
- Forward friction coupling
- Cylindrical carbide tipped measuring faces
- Measuring jaws on both sides (measuring ranges 5-30 mm, 30-55 mm)
- Divisions on both sides

Delivery

- Wooden case

✂	¼	Measuring range mm	Thimble dia. mm	Pitch mm	Error limit µm	Order no.	List price EUR
		5 - 55	20	0.5	2.5	0884 501	885.00

0885 Internal micrometers with measuring jaws



0885 502

Model

- Factory standard
- Reading: 0.01 mm
- Reading parts and body are satin chrome finished
- Ratchet stop
- Carbide measuring faces
- Cylindrical carbide tipped measuring faces

Delivery

- Plastic case

✂	¼	Measuring range mm	Thimble dia. mm	Pitch mm	Order no.	List price EUR
		5 - 30	17	0.5	0885 501*	183.00
		25 - 50	17	0.5	0885 502	203.00
		50 - 75	17	0.5	0885 503	213.00
		75 - 100	17	0.5	0885 504	255.00
		100 - 125	17	0.5	0885 505	324.00
		125 - 150	17	0.5	0885 506	374.00
		150 - 175	17	0.5	0885 507	476.00
		175 - 200	17	0.5	0885 508	540.00



0888 Internal micrometers cylindrical version



Model

- DIN 863-4
- Reading: 0.01 mm
- Reading parts are satin chrome finished
- Carbide measuring faces dia. 6 mm, spherical lapped
- From measuring range 100 - 125 mm with thermal insulation

DIN
863-4

- From measuring range 100 - 125 mm with locking ring

Delivery

- Wooden case

⌂	⌂	Measuring range mm	Thimble dia. mm	Pitch mm	Error limit µm	Order no.	List price EUR
		25 - 30	15	0.5	4	0888 501	171.00
		30 - 35	15	0.5	4	0888 502	171.00
		35 - 50	15	0.5	4	0888 503	171.00
		50 - 75	16	0.5	5	0888 504	179.00
		75 - 100	17	0.5	5	0888 505	185.00
		100 - 125	20	0.5	6	0888 506	207.00
		125 - 150	20	0.5	6	0888 507	212.00
		150 - 175	20	0.5	7	0888 508	219.00
		175 - 200	20	0.5	7	0888 509	228.00
		200 - 225	20	0.5	8	0888 510	234.00
		225 - 250	20	0.5	8	0888 511	241.00
		250 - 275	20	0.5	9	0888 512	249.00
		275 - 300	20	0.5	9	0888 513	259.00
		300 - 325	20	0.5	10	0888 514	269.00
		325 - 350	20	0.5	10	0888 515	275.00
		350 - 375	20	0.5	11	0888 516	287.00
		375 - 400	20	0.5	11	0888 517	293.00
		400 - 425	20	0.5	12	0888 518	304.00
		425 - 450	20	0.5	12	0888 519	314.00
		450 - 475	20	0.5	13	0888 520	321.00
		475 - 500	20	0.5	13	0888 521	328.00

0888 Holder for internal micrometers



Model

- Ideal for all internal micrometers from series 0888 / 0892
- Length 200 mm

⌂	⌂	Order no.	List price EUR
		0888 101	55.00



0892 Internal micrometers with interchangeable extensions



DIN
863-4



0892 501

Model

- DIN 863-4
- Reading: 0.01 mm
- Reading parts are satin chrome finished

Delivery

- Threaded extension rods with thermally insulated handle
- Carbide measuring faces, spherical lapped
- Wooden case

✂	%	Measuring range	Thimble dia.	Pitch	Extensions	Error limit	Order no.	List price
		mm	mm	mm		µm		EUR
		50 - 150	17	0.5	25 / 50	6	0892 501	419.00
		50 - 250	17	0.5	25 / 50 / 100	8	0892 502	514.00
		50 - 450	17	0.5	25 / 50 / 100 / 200	10	0892 503	633.00
		50 - 850	17	0.5	25 / 50 / 100 / 200 / 400	12	0892 504	798.00
		50 - 1450	17	0.5	25 / 50 / 100 / 200 / 400 / 600	15	0892 505	1013.00

0892 Extensions for internal micrometers



0892 334

✂	%	Length mm	Order no.	List price EUR
		25	0892 332	79.00
		50	0892 333	80.00
		100	0892 334	89.00
		200	0892 336	109.00
		400	0892 339	144.00
		600	0892 340	203.00



0894 Precision internal micrometers with extensions

DIN 863-4



Model

- DIN 863-4
- Measuring ends: dia. 7 mm x 6 mm long, carbide tipped spherical lapped
- Thread pitch 1 mm
- Internal spring mounted rods with thermal protective sleeves

- Extensions greater than 100 mm: external steel tube dia. 17 mm, with thermal insulation
- Extensions 500 and 1000 mm: strengthened specification - steel tube dia. 32 mm

- Basic internal micrometer is adjustable: 50 mm. The spindle is tight, so that during measurement the thimble does not adjust itself.

Delivery

- Wooden case

✕	⊘	Measuring range mm	Length of extensions mm (tube dia. 17 mm)	Length of extensions mm (tube dia. 32 mm)	Error limit μm	Order no.	List price EUR
		100 - 150	only micrometer, excludes case	-	4	0894 504	249.00
		100 - 300	50 / 100	-	7	0894 510	663.00
		100 - 500	50 / 100 / 200	-	9	0894 514	895.00
		100 - 900	50 / 100 / 200 / 400	-	11	0894 518	1156.00
		100 - 1300	50 / 100 / 200 / 400 / 400	-	13	0894 522	1423.00
		100 - 1700	50 / 100 / 200 / 400 / 800	-	15	0894 526	1464.00
		100 - 2100	50 / 100 / 200 / 400 / 400 / 800	-	18	0894 530	1717.00
		100 - 2500	50 / 100 / 200 / 400 / 800 / 800	-	21	0894 534	1763.00
		100 - 2000	50 / 100 / 200 / 200	500 / 1 x 1000	18	0894 538	3078.00
		100 - 3000	50 / 100 / 200 / 200	500 / 2 x 1000	30	0894 542	4015.00
		100 - 4000	50 / 100 / 200 / 200	500 / 3 x 1000	40	0894 546	4984.00
	▪	100 - 5000	50 / 100 / 200 / 200	500 / 4 x 1000	50	0894 550	5921.00
	▪	100 - 6000	50 / 100 / 200 / 200	500 / 5 x 1000	60	0894 554	6859.00

With the larger measuring ranges we recommend that the ends of the precision internal micrometer to be placed and/or held on 2 points with an approximate distance of 22% of the measuring length, thus minimizing deflection. The error indicated in the table above refers to the maximum deflection of the appropriate set. When smaller dimensions are measured, the error is smaller and corresponds to the error value of the smaller sets.

0894 Individual extensions



✕	⊘	Length mm	Tube dia. mm	Order no.	List price EUR
		50	17	0894 804	179.00
		100	17	0894 806	203.00
		200	17	0894 810	219.00
		400	17	0894 820	242.00
		800	17	0894 834	275.00
		500	32	0894 854	904.00
		1000	32	0894 872	938.00



1921 3 point internal micrometers



**DIN
863-4**



1921 512



1921 534

Model

- DIN 863-4
- Reading: 0.001 mm*
- Reading: 0.005 mm
- Reading parts are satin chrome finished
- Pitch 0.5 mm
- Carbide tipped measuring pins from measuring range 12 mm

Delivery

- Plastic case
- Incl. setting ring
- Calibration certificate for ring and micrometer



Inclusive!

✂	📏	Measuring range mm	Measuring depth mm	Thimble dia. mm	Error limit µm	Order no.	List price EUR
▪		6 - 8	58	16	4	1921 510*	398.00
▪		8 - 10	58	16	4	1921 512*	398.00
▪		10 - 12	58	16	4	1921 514*	398.00
▪		12 - 16	64	16	4	1921 516*	398.00
▪		16 - 20	64	16	4	1921 518*	422.00
▪		20 - 25	68	25	4	1921 520	433.00
▪		25 - 30	68	25	4	1921 522	439.00
▪		30 - 40	76	25	4	1921 524	493.00
▪		40 - 50	76	25	4	1921 526	493.00
▪		50 - 60	79	25	5	1921 528	568.00
▪		60 - 70	79	25	5	1921 530	585.00
▪		70 - 85	97	25	5	1921 532	601.00
▪		85 - 100	97	25	5	1921 534	617.00
▪		100 - 125	132	25	6	1921 536	866.00
▪		125 - 150	132	25	6	1921 538	1023.00
▪		150 - 175	132	25	7	1921 540	1077.00
▪		175 - 200	132	25	7	1921 542	1137.00



1920 Set of 3 point internal micrometers



**DIN
863-4**



Model

- DIN 863-4
- Reading: 0.001 mm*
- Reading: 0.005 mm
- Reading parts are satin chrome finished
- Pitch 0.5 mm
- Carbide tipped measuring pins from measuring range 12 mm
- Ratchet stop
- From measuring range 12 mm for through and blind holes

Delivery

- Plastic case
- Incl. setting ring
- Calibration certificate for ring and micrometer

2

⌘	⚙	Measuring range mm	Thimble dia. mm	Number of devices	Order no.	List price EUR
▪		6 - 12	16	3	1920 574	1126.00
▪		12 - 20	16	2	1920 576	790.00
▪		20 - 50	25	4	1920 578	1949.00
▪		50 - 100	25	4	1920 580	2328.00

1920 Measuring depth extensions for 3 point internal micrometers



Model

- Suitable for devices 1920, 1921, 1923 and 1924



⌘	⚙	Measuring range mm	Length mm	Order no.	List price EUR
		6 - 12	75	1920 910	92.00
		12 - 20	75	1920 914	98.00
		20 - 30	100	1920 920	103.00
		30 - 200	100	1920 924	124.00



1923 DIGI-MET® 3 point internal micrometers



Model

- DIN 863-4
- Reading: 0.001 mm / .00005 inch
- Protection class IP52
- LCD display 8.5 mm
- Ratchet stop
- For through holes
- From measuring range 12 mm for through and blind holes
- From measuring range 12 mm with carbide tipped measuring faces

Functions

- ON / OFF
- Set to zero at any point
- mm / inch switching
- ABS (display can be set to zero without losing the Preset value)
- **Quick-Lock** (key lock)
- PRESET-Function (setting a numerical value)
- Variable data output RS 232 + Digimatic + USB

Delivery

- Plastic case
- Incl. setting ring
- Calibration certificate for setting ring and micrometer



Inclusive!

✕	☒	Measuring range mm	Measuring depth mm	Error limit µm	Order no.	List price EUR
▪		6 - 8	58	4	1923 510	1099.00
▪		8 - 10	58	4	1923 512	1099.00
▪		10 - 12	58	4	1923 514	1110.00
▪		12 - 16	64	4	1923 516	1110.00
▪		16 - 20	64	4	1923 518	1157.00
▪		20 - 25	68	4	1923 520	1177.00
▪		25 - 30	68	4	1923 522	1188.00
▪		30 - 40	76	4	1923 524	1240.00
▪		40 - 50	76	4	1923 526	1245.00
▪		50 - 60	79	5	1923 528	1339.00
▪		60 - 70	79	5	1923 530	1370.00
▪		70 - 85	97	5	1923 532	1401.00
▪		85 - 100	97	5	1923 534	1454.00
▪		100 - 125	132	6	1923 536	1766.00
▪		125 - 150	132	6	1923 538	1975.00
▪		150 - 175	132	7	1923 540	2126.00
▪		175 - 200	132	7	1923 542	2308.00



1998720



1998501



1997501

Accessories

	Order no.	List price EUR
Battery, 3V-Lithium, CR 2032	0220 704	3.90
Data cable DATA VARIABLE to RS232	1997 501	50.00
Data cable DATA VARIABLE to digimatic	1998 501	64.00
Data cable DATA VARIABLE to USB	1998 720	72.00



HELIOS · PREISSER

1923 DIGI-MET® Set of 3 point internal micrometers



Delivery

- Plastic case
- Incl. setting ring
- Calibration certificate for setting ring and micrometer



Measuring range	Error limit	Number of devices	Order no.	List price
mm	µm			EUR
6 - 12	4	3	1923 574	1771.00
12 - 20	4	2	1923 576	1563.00
20 - 50	4	4	1923 578	2292.00
50 - 100	5	4	1923 580	2813.00



1998720

1998501

1997501

Accessories

	Order no.	List price
		EUR
Battery, 3V-Lithium, CR 2032	0220 704	3.90
Data cable DATA VARIABLE to RS232	1997 501	50.00
Data cable DATA VARIABLE to digimatic	1998 501	64.00
Data cable DATA VARIABLE to USB	1998 720	72.00

1923 DIGI-MET® Basic unit for 3 point internal micrometers



Model

- Reading: 0.001 mm / .00005 inch
- Protection class IP52
- LCD display 8.5 mm
- Ratchet stop
- Mounting thread for changing of measuring heads

Functions

- ON / OFF
- Set to zero at any point
- mm / inch switching
- ABS (display can be set to zero without losing the Preset value)
- Quick-Lock (key lock)
- PRESET-Function (setting a numerical value)
- Variable data output RS 232 + Digimatic + USB

Measuring range	Order no.	List price
mm		EUR
6 - 20	1923 100	797.00
20 - 100	1923 200	797.00
100 - 200	1923 300	797.00

Single measuring heads on page 106



1924 DIGI-MET® 3 point internal measuring pistols



Model

- For through holes
- Mounting thread for changing of measuring heads
- From measuring range 12 mm for through and blind holes
- From measuring range 12 mm with carbide tipped measuring faces
- Digital indicator recommended as display device

Delivery

- Plastic case
- Incl. setting ring
- Without display device
- Calibration certificate
for setting ring included



Inclusive!

⌘	⚙	Measuring range mm	Measuring depth mm	Order no.	List price EUR
▪		6 - 8	58	1924 510	818.00
▪		8 - 10	58	1924 512	818.00
▪		10 - 12	58	1924 514	828.00
▪		12 - 16	64	1924 516	839.00
▪		16 - 20	64	1924 518	870.00
▪		20 - 25	68	1924 520	870.00
▪		25 - 30	68	1924 522	901.00
▪		30 - 40	76	1924 524	948.00
▪		40 - 50	76	1924 526	953.00
▪		50 - 60	79	1924 528	1037.00
▪		60 - 70	79	1924 530	1078.00
▪		70 - 85	97	1924 532	1115.00
▪		85 - 100	97	1924 534	1167.00
▪		100 - 125	132	1924 536	1438.00
▪		125 - 150	132	1924 538	1657.00
▪		150 - 175	132	1924 540	1771.00
▪		175 - 200	132	1924 542	1980.00

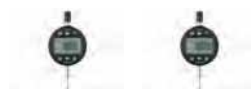

1726506

172650660

Accessories

- DIGI-MET® Indicator
- DIGI-MET® Indicator with integrated wireless

Order no.

1726 506
172650 660

List price
EUR

380.00
425.00

Calibration certificate for pistol and head only possible in combination with an Indicator



1924 DIGI-MET® Set of 3 point internal measuring pistols



Model

- For through holes
- From measuring range 12 mm for through and blind holes
- From measuring range 12 mm with carbide tipped measuring faces
- Digital indicator recommended as display device

Delivery

- Plastic case
- Incl. setting ring
- Without display device
- Calibration certificate **for setting ring** included

Measuring range mm	Number of devices	Order no.	List price EUR
6 - 12	3	1924 574	1459.00
12 - 20	2	1924 576	1250.00
20 - 50	4	1924 578	2084.00
50 - 100	4	1924 580	2709.00

Calibration certificate for pistol and head on request, only possible in combination with an Indicator

1924 DIGI-MET® Basic unit for 3 point internal measuring pistols



Model

- Mounting thread for changing of measuring heads
- Support for indicators with shaft \varnothing 8 mm
- Measuring range 6-100 mm incl. adapter for 6-20 mm

Delivery

- Plastic case

Measuring range mm	Order no.	List price EUR
6 - 100	1924 100	500.00
20 - 100	1924 200	500.00
100 - 200	1924 300	584.00

Accessories

Accessories	Order no.	List price EUR
Replacement adapter 6-20 mm for measuring pistol 1924 100	1924 190	79.00

Single measuring heads on page 106



1922 Individual measuring heads for 1923 / 1924



1922 512



1922 534

Model

- Self centering measuring head with three anvils, offset at intervals of 120°
- From measuring range 12 mm with carbide tipped measuring faces
- From measuring range 12 mm for through and blind holes
- From measuring range 40 mm, measuring heads are made of aluminium to reduce weight
- Can only be used on digital internal micrometers

✂	📏	Measuring range mm	Order no.	List price EUR
		6 - 8	1922 510	302.00
		8 - 10	1922 512	302.00
		10 - 12	1922 514	307.00
		12 - 16	1922 516	307.00
		16 - 20	1922 518	318.00
		20 - 25	1922 520	328.00
		25 - 30	1922 522	339.00
		30 - 40	1922 524	380.00
		40 - 50	1922 526	380.00
		50 - 60	1922 528	453.00
		60 - 70	1922 530	464.00
		70 - 85	1922 532	479.00
		85 - 100	1922 534	495.00
		100 - 125	1922 536	724.00
		125 - 150	1922 538	880.00
		150 - 175	1922 540	953.00
		175 - 200	1922 542	985.00

1920 Measuring depth extensions for 3 point internal micrometers



Model

- Suitable for devices 1920, 1921, 1923 and 1924



✂	📏	Measuring range mm	Length mm	Order no.	List price EUR
		6 - 12	75	1920 910	92.00
		12 - 20	75	1920 914	98.00
		20 - 30	150	1920 920	103.00
		30 - 200	150	1920 924	124.00



0882 Depth micrometers



DIN
863-2

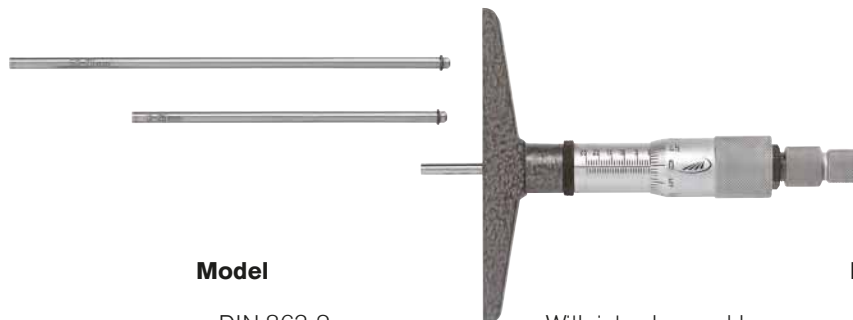

Model

- DIN 863-2
- Reading: 0.01 mm
- Reading parts are satin chrome finished
- Locking ring
- Friction coupling

Delivery

- Wooden case

- With interchangeable steel measuring inserts dia. 4 mm
- Hardened measuring faces

»	¼	Measuring range mm	Length of beam mm	Pitch mm	Thimble dia. mm	Error limit mm	Order no.	List price EUR
Measuring faces dia. 0.8 mm, length 8.5 mm								
		0 - 50	50	0.5	20	0.004	0882 300	293.00
		0 - 75	50	0.5	20	0.005	0882 301	319.00
		0 - 100	100	0.5	20	0.005	0882 303	350.00
		0 - 150	100	0.5	20	0.006	0882 304	410.00
		0 - 300	100	0.5	20	0.009	0882 306	660.00

0886 Micrometer heads



DIN
863-2



Model

- DIN 863-2
- Reading: 0.01 mm
- Reading parts are satin chrome finished
- Carbide measuring faces

Delivery

- Plastic case



»	¼	Measuring range mm	Spindle dia. mm	Thimble dia. mm	Attachement dia. mm	Error limit mm	Description	Order no.	List price EUR
		0 - 6.5	3.5	9.5	6.0	0.003	without ratchet stop	0886 503	24.40
		0 - 13	6.5	13.5	9.5	0.003	without ratchet stop	0886 505	28.10
		0 - 25	6.5	18	12	0.003	with ratchet stop	0886 507	24.40
		0 - 25	8	18	12	0.003	ratchet stop, non-rotating spindle	0886 513	43.30



SAMPLES INDICATORS

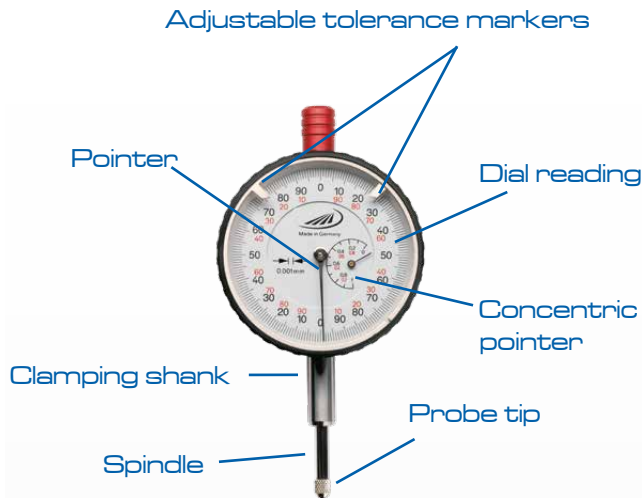

Specifications

- Housing made from metal or polyamide
- Replacement probe tips M 2.5
- Shockproof devices available
- Water and oil proof devices available

Electronic functions

QuickStart Electronic:
Moving the spindle starts your measurement



QuickLock Function:
Single keys can be locked individually



Data Variable:
Interface for USB, RS 232 & Digimatic



Integrated data transmission (Integrated Wireless)



Individual tolerance limit values

Data Variable Interface



Combined analogue / digital display

1734i

with integrated wireless

Matching accessories for our Indicators



MEASURING TABLES



MEASURING STANDS

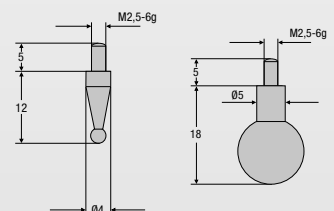

MEASURING INSERTS

3. CHAPTER INDICATORS

110	Indicators
117	Dial gauges
122	Precision indicators
123	Accessories for dial gauges and precision indicators
125	Measuring inserts for dial gauges
129	Dial test indicators
131	Depth gauges, depth measuring base
132	Dial thickness gauge
133	Internal bore gauges for blind holes
134	Crankshaft gauges / Length measuring instruments
135	Universal comparator gauge
138	Comparator gauge UHRTAST
144	Magnetic measuring stands
148	Measuring tables
151	Bench centres
158	Shaft measuring instruments



1722 / 1723 / 1724 DIGI-MET® Indicators



1722 502



1723 502



1724 502

Model

- Outer ring (Bezel) Ø 60 mm
- Replacement probe tip M 2.5
- Protection class IP52
- Clamping shank Ø 8 mm
- LCD display with 12 mm high numerals
- Accuracy according to factory standard

Functions

- ON / OFF
- **Quick-Start**
- **Quick-Lock** (key lock)
- Set to zero at any point
- Reversal of counting direction
- mm / inch switching
- Individual key lock

Delivery

- Cardboard box

- PRESET-Function (setting a numerical value)
- Variable data output RS 232 + Digimatic + USB

Measuring span	Resolution		Error limit	Measuring force	Order no.	List price
	mm	inch				
12.5	0.01	.0005	0.02	0.5 - 1	1722 502	142.00
12.5	0.005	.0001	0.015	0.5 - 1	1723 502	179.00
12.5	0.001	.00005	0.005	0.5 - 1	1724 502	296.00



1998720



1997501



1998501

Accessories

	Order no.	List price
Battery, 3V-Lithium, CR 2032	0220 704	3.90
Data cable Data Variable to USB	1998 720	72.00
Data cable Data Variable to RS232	1997 501	50.00
Data cable Data Variable to digimatic	1998 501	64.00
Cable release (12,5 mm)	1739 920	14.90



1726 / 1728 DIGI-MET® Indicators



1726 502



1728 502

Model

- Aluminium housing
- Hardened stainless steel spindle
- Outer ring (Bezel) Ø 60 mm
- Replacement probe tip M 2.5
- Protection class IP42
- Clamping shank Ø 8 mm
- Display unit can be rotated through 280°
- LCD display with 11 mm high numerals
- Factory standard

Functions

- ON / OFF
- Quick-Start**
- Quick-Lock** (key lock)
- Set to zero at any point
- mm / inch switching
- ABS (display can be set to zero without losing the Preset value)
- TOL (tolerance value input)
- Reversal of counting direction
- Factor input

Delivery

- Cardboard box

⏏	📏	Measuring span		Resolution		Error limit		Repeatability	Measuring force	Order no.	List price
		mm		mm	inch	total span mm	partial span** mm				
Reading 0.001 mm											
		12.5		0.001*	.00005	0.004	0.002	0.001	0.65 - 0.9	1726 502	345.00
		25		0.001*	.00005	0.004	0.002	0.001	0.65 - 1.15	1726 506	380.00
		50		0.001*	.00005	0.007	0.002	0.001	1.25 - 2.7	1726 510	669.00
		100		0.001*	.00005	0.008	0.002	0.001	1.6 - 3.5	1726 514	828.00
Reading 0.01 mm											
		12.5		0.01	.0005	0.02		0.01	0.65 - 0.9	1728 502	289.00
		25		0.01	.0005	0.02		0.01	0.65 - 1.15	1728 506	368.00
		50		0.01	.0005	0.02		0.01	1.25 - 2.7	1728 510	600.00
		100		0.01	.0005	0.02		0.01	1.6 - 3.5	1728 514	768.00

* Reading switchable: 0.0005 / 0.001 / 0.002 / 0.005 / 0.010 mm

** Partial span = 25 steps by step value 0.0005 mm



1998720

1998501

1997501

Accessories

	Order no.	List price
Battery, 3V-Lithium, CR 2450	1998 770	5.90
Data cable Data Variable to USB	1998 720	72.00
Data cable Data Variable to RS232	1997 501	50.00
Data cable Data Variable to digimatic	1998 501	64.00
Cable release (12,5 mm)	1739 910	40.00



= QuickLock



= QuickStart



= Waterproof acc. IP



= Data output



= DIN



1730 DIGI-MET® Indicators



Model

- Aluminium housing
- Outer ring (Bezel) Ø 60 mm
- Replacement probe tip M 2.5
- Protection class IP54
- Clamping shank Ø 8 mm
- Display unit can be rotated through 280°
- LCD display with 11 mm high numerals
- Factory standard

Functions

- ON / OFF
- Quick-Start**
- Quick-Lock** (key lock)
- Set to zero at any point
- mm / inch switching
- ABS (display can be set to zero without losing the Preset value)
- TOL (tolerance value input)
- Reversal of counting direction

Delivery

- Cardboard box

Measuring span	Resolution			Error limit		Repeatability	Measuring force	Order no.	List price
	mm	mm	inch	total span mm	partial span** mm				
12.5	0.001	.00005		0.004	0.002	0.001	0.65 - 0.9	1730 502	382.00
25	0.001	.00005		0.004	0.002	0.001	0.65 - 1.15	1730 506	431.00

* Reading switchable: 0.0005 / 0.001 / 0.002 / 0.005 / 0.010 mm

** Partial span= 25 steps by step value 0.0005 mm



1998720

1998501

1997501

Accessories

	Order no.	List price
Battery, 3V-Lithium, CR 2450	1998 770	5.90
Data cable Data Variable to USB	1998 720	72.00
Data cable Data Variable to RS232	1997 501	50.00
Data cable Data Variable to digimatic	1998 501	64.00
Cable release (12,5 mm)	1739 910	40.00



1734 DIGI-MET® indicators with combined analogue / digital display



1734 502



1734 506

Model

- Aluminium housing
- Hardened stainless steel spindle
- Outer ring (Bezel) Ø 60 mm
- Replacement probe tip M 2.5
- Protection class IP42
- Clamping shank Ø 8 mm
- Display unit can be rotated through 280°
- LCD display with 8.5 mm high numerals
- Factory standard

Functions

- ON / OFF
- Quick-Start**
- Quick-Lock** (key lock)
- Set to zero at any point
- mm / inch switching
- ABS (display can be set to zero without losing the Preset value)
- TOL (tolerance value input)
- MIN / MAX
- TIR (MIN-MAX differential)
- Reversal of counting direction

Delivery

- Cardboard box

Measuring span	Resolution		Error limit		Repeatability	Measuring force	Order no.	List price
	mm	inch	total span mm	partial span** mm				
12.5	0.001	.00005	0.004	0.002	0.001	0.65 - 0.9	1734 502	397.00
25	0.001	.00005	0.004	0.002	0.001	0.65 - 1.15	1734 506	455.00

* Reading switchable: 0.0005 / 0.001 / 0.002 / 0.005 / 0.010 mm

** Partial span= 25 steps by step value 0.0005 mm



1998720

1998501

1997501

Accessories

	Order no.	List price EUR
Battery, 3V-Lithium, CR 2450	1998 770	5.90
Data cable Data Variable to USB	1998 720	72.00
Data cable Data Variable to RS232	1997 501	50.00
Data cable Data Variable to digimatic	1998 501	64.00
Cable release (12,5 mm)	1739 910	40.00



1734 DIGI-MET® indicator with combined analogue / digital display



for comparator gauges



1734 522

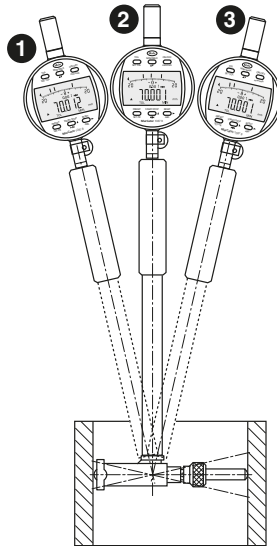

Application

The turning point can be determined automatically in measurements with a 2 point internal measuring device through commuting. The actual value is detected and stored by the MIN function and appears on the display.

Model

- Aluminium housing
- Hardened stainless steel spindle
- Outer ring (Bezel) Ø 60 mm
- Replacement probe tip M 2.5
- Protection class IP42
- Clamping shank Ø 8 mm
- Display unit can be rotated through 280°
- LCD display with 8.5 mm high numerals
- Factory standard

Functions

- ON / OFF
- Quick-Start**
- Quick-Lock** (key lock)
- Set to zero at any point
- mm / inch switching
- ABS (display can be set to zero without losing the Preset value)
- TOL (tolerance value input)
- MIN / MAX
- Reversal of counting direction
- Factor input
- Individual key lock
- Variable data output RS 232 + Digimatic + USB
- PRESET-Function (setting a numerical value)

Delivery

- Cardboard box

Measuring span	Resolution		Error limit		Repeatability	Measuring force	Order no.	List price
	mm	inch	total span mm	partial span** mm				
12.5	0.001	.00005	0.004	0.002	0.001	0.65 - 0.9	1734 522	515.00

* Reading switchable: 0.0005 / 0.001 / 0.002 / 0.005 / 0.010 mm

** Partial span = 25 steps by step value 0.0005 mm

Accessories

	Order no.	List price
Battery, 3V-Lithium, CR 2450	1998 770	5.90
Data cable Data Variable to USB	1998 720	72.00
Data cable Data Variable to RS232	1997 501	50.00
Data cable Data Variable to digimatic	1998 501	64.00
Cable release (12,5 mm)	1739 910	40.00



1998720

1998501

1997501



1726i / 1734i DIGI-MET® Indicators with integrated wireless



1726 50260



1734 50260



integrated IW wireless

Wireless Data Transmission



Model

- Aluminium housing
- Outer ring (Bezel) Ø 60 mm
- Replacement probe tip M2.5
- Protection class IP42
- Clamping shank Ø 8mm
- Display can be rotated through 280°
- LCD display with 11 mm high numerals
- Factory standard

Functions

- ON / OFF
- Quick-Start**
- Quick-Lock** (key lock)
- Set to zero at any point
- mm / inch switching
- ABS (display can be set to zero without losing the Preset value)
- TOL (tolerance value input)
- Reversal of counting direction

- Factor input
- Individual key lock
- PRESET-Function (setting a numerical value)
- Variable data output RS 232 + Digimatic + USB
- Integrated Wireless

Delivery

- Cardboard box

More information on our i-series and Integrated Wireless on page 252

Measuring span	Resolution		Error limit		Repeatability	Measuring force	Order no.	List price
	mm	mm	inch	total span mm				
12.5	0.0005	.00002	0.004	0.002	0.001	0.65 - 0.9	1726 50260	391.00
25	0.0005	.00002	0.004	0.002	0.001	0.65 - 1.15	1726 50660	425.00
With combined analogue / digital display and MIN / MAX / TIR Function								
12.5	0.0005	.00002	0.004	0.002	0.001	0.65 - 0.85	1734 50260	441.00
25	0.0005	.00002	0.004	0.002	0.001	0.65 - 0.9	1734 50660	497.00

* Reading switchable: 0.0005 / 0.001 / 0.002 / 0.005 / 0.010 mm
 ** Partial span= 25 steps by step value 0.0005 mm



1998780

Accessories

	Order no.	List price
Battery, 3V-Lithium, CR 2450	1998 770	5.90
Data cable Data Variable to USB	1998 720	72.00
Data cable Data Variable to RS232	1997 501	50.00
Data cable Data Variable to digimatic	1998 501	64.00
Cable release (12,5 mm)	1739 910	40.00
i-Stick USB-receiver for Integrated Wireless	1998 780	95.00

Integrated Wireless is intended to be sold in the European Economic Area only



0691 DIGI-MET® Indicators



Model

- Aluminium housing
- Outer ring (Bezel) Ø 60 mm
- Replacement probe tip M 2.5
- Protection class IP51
- Water and coolant resistant
- Clamping shank Ø 8 mm
- Display unit can be rotated through 270°
- LCD display with 11 mm high numerals
- Factory standard

Functions

- ON / OFF
- Set to zero at any point
- mm / inch switching
- PRESET-Function (setting a numerical value)
- Reversal of counting direction
- Data interface RS232 Proximity (cable no. 1998 760)

* Additional functions: models 0691 751 + 0691 753

- TOL (tolerance value input)
- Factor input
- MIN / MAX
- TIR (MIN-MAX differential)

Delivery

- Cardboard box



0691 733



0691 735



0691 747



Measuring span	Resolution		Error limit	Order no.	List price
	mm	inch			
Reading 0.01 mm					
12.5	0.01	.0005	0.01	0691 731	378.00
25	0.01	.0005	0.01	0691 733	433.00
50	0.01	.0005	0.02	0691 735	943.00
100	0.01	.0005	0.02	0691 737	1063.00
Reading 0.001 mm					
12.5	0.001	.00005	0.004	0691 741	467.00
25	0.001	.00005	0.005	0691 743	512.00
50	0.001	.00005	0.007	0691 745	1045.00
100	0.001	.00005	0.008	0691 747	1207.00
Reading 0.001 mm, with additional functions*					
12.5	0.001	.00005	0.003	0691 751	543.00
25	0.001	.00005	0.004	0691 753	600.00



0701 Small dial gauges with lightweight plastic housing



Model

- Lightweight housing made of polyamide
- Measuring spindle is made of stainless steel
- Replacement probe tip M 2.5
- Clamping shank Ø 8 mm
- DIN 878

Delivery

- Fitted case

DIN
878

☒ ☒	Measuring span mm	Scale graduation value mm	Range per rev. mm	Outer ring (Bezel) Ø mm	Order no.	List price EUR
Small dial gauge						
	5	0.01	0.5	40	0701 101	44.60
Shockproof small dial gauge						
	5	0.01	0.5	40	0701 102	56.00

3

0708 Small dial gauges



0708 101



0708 102

Model

- Metal housing
- Measuring spindle is made of stainless steel
- Replacement probe tip M 2.5
- Clamping shank Ø 8 mm
- With a revolution counter
- DIN 878

Delivery

- Fitted case

DIN
878

☒ ☒	Measuring span mm	Scale graduation value mm	Range per rev. mm	Outer ring (Bezel) Ø mm	Order no.	List price EUR
	10	0.01	1.0	40	0708 101	96.00
	5	0.01	0.5	40	0708 102	61.00
	3	0.01	0.5	32	0708 103	74.00
	3	0.01	0.5	40	0708 104	50.00
Shockproof small dial gauge						
	3	0.01	0.5	40	0708 105	61.00
	5	0.01	0.5	40	0708 106	81.00



0701 Dial gauges



DIN
878



0701 106



0701 110

Model

- Measuring spindle is made of stainless steel
- Replacement probe tip M 2.5
- Clamping shank \varnothing 8 mm
- DIN 878
- 0701 103 = Factory standard

Delivery

- Fitted case

✕	☒	Measuring span mm	Scale graduation value mm	Range per rev. mm	Outer ring (Bezel) \varnothing mm	Order no.	List price EUR
		Dial gauge, plastic housing					
		10	0.01	1	58	0701 103	24.00
		Dial indicator with shock protection, injection-molded housing					
		10	0.01	1	58	0701 106	25.00
		Dial gauge, metal housing					
		10	0.01	1	58	0701 110	41.70
		Shockproof dial gauge, metal housing					
		10	0.01	1	58	0701 111	47.90

0703 Dial gauges with extended measuring range



0703 101

Model

- Metal housing
- Measuring spindle is made of stainless steel
- Replacement probe tip M 2.5
- Clamping shank \varnothing 8 mm
- With a concentric pointer
- Factory standard

Delivery

- Fitted case

✕	☒	Measuring span mm	Scale graduation value mm	Range per rev. mm	Outer ring (Bezel) \varnothing mm	Order no.	List price EUR
		30	0.01	1	58	0703 101	110.00
		50	0.01	1	58	0703 104	153.00
		80	0.01	1	58	0703 107	307.00



0704 Shockproof dial gauges



0704 105



0704 109

Model

- Metal housing
- Measuring spindle is made of stainless steel
- Replacement probe tip M 2.5
- Clamping shank Ø 8 mm
- Shockproof

Delivery

- Fitted case

DIN 878

Icon	Measuring span mm	Scale graduation value mm	Range per rev. mm	Outer ring (Bezel) Ø mm	Order no.	List price EUR
Revolution counter: DIN 878						
	10	0.01	1	58	0704 105	78.00
With fine adjustment of the pointer: DIN 878						
	10	0.01	1	58	0704 106	96.00
Concentric pointer: Factory standard						
	30	0.01	1	58	0704 109	126.00
	50	0.01	1	58	0704 110	163.00

3

0707 Water and oil proof dial gauges



0707 102

Model

- Metal housing, water and oil proof
- Protection class IP67
- Measuring spindle is made of stainless steel
- Replacement probe tip M 2.5
- Clamping shank Ø 8 mm
- Rubber bellows
- Shockproof
- Outer ring (Bezel) can be rotated through 360°
- DIN 878

Delivery

- Fitted case



DIN 878

Icon	Measuring span mm	Scale graduation value mm	Range per rev. mm	Outer ring (Bezel) Ø mm	Order no.	List price EUR
	3	0.01	0.5	44.5	0707 101	138.00
	10	0.01	1	61.5	0707 102	118.00



0700 Dial gauges, graduation 0.1 mm



0700 102



0700 104

Model

- Metal housing
- Measuring spindle is made of stainless steel
- Replacement probe tip M 2.5
- Clamping shank Ø 8 mm
- Factory standard

Delivery

- Fitted case

	Measuring span mm	Scale graduation value mm	Range per rev. mm	Outer ring (Bezel) Ø mm	Order no.	List price EUR
	10	0.1	10	40	0700 100	67.00
	5	0.1	5	40	0700 101	67.00
	10	0.1	10	58	0700 102	51.00
Straight line revolution counter						
	30	0.1	10	58	0700 104	59.00

0702 Dial gauge with concentric mm display



0702 106

Model

- Metal housing
- Measuring spindle is made of stainless steel
- Replacement probe tip M 2.5
- Clamping shank Ø 8 mm
- With a concentric pointer
- DIN 878

Delivery

- Fitted case

**DIN
878**

	Measuring span mm	Scale graduation value mm	Range per rev. mm	Outer ring (Bezel) Ø mm	Order no.	List price EUR
	10	0.01	1	58	0702 106	68.00



0705 Precision dial gauges



0705 102

Model

- Metal housing
- Measuring spindle is made of stainless steel
- Replacement probe tip M 2.5
- Clamping shank Ø 8 mm
- With a revolution counter
- Factory standard

Delivery

- Fitted case

☒	☒	Measuring span mm	Scale graduation value mm	Range per rev. mm	Outer ring (Bezel) Ø mm	Order no.	List price EUR
		1	0.001	0.2	40	0705 102	121.00
		1	0.001	0.2	58	0705 104	121.00
		5	0.001	0.2	58	0705 105	126.00
Precision shockproof dial gauge							
		1	0.001	0.2	40	0705 107	128.00
		5	0.001	0.2	58	0705 109	156.00

3

0706 Error free, shockproof dial gauge



0706 102

Model

- Metal housing
- Measuring spindle is made of stainless steel
- Replacement probe tip M 2.5
- Clamping shank Ø 8 mm
- DIN 878

Delivery

- Fitted case

DIN
878

☒	☒	Measuring span mm	Scale graduation value mm	Dial reading	Overtravel mm mm	Outer ring (Bezel) Ø mm	Order no.	List price EUR
		0.8	0.01	40-0-40	1	58	0706 102	78.00



0709 Dial gauges with reverse action plunger



Model

- Metal housing
- Measuring spindle is made of stainless steel
- Replacement probe tip M 2.5
- Clamping shank \varnothing 8 mm
- Factory standard

Delivery

- Fitted case

☒ ☒	Measuring span	Scale graduation value	Range per rev.	Outer ring (Bezel)	Order no.	List price
	mm	mm	mm	\varnothing mm		EUR
	3	0.01	0.5	40	0709 101	116.00
	5	0.01	1	58	0709 108	138.00

0712 Dial comparator gauge MICROTAST



0712 121



0712 124

Model

- Measuring spindle is made of hardened stainless steel
- Longer measuring spindle
- Replacement probe tip M 2.5
- Clamping shank \varnothing 8 mm
- Tolerance markers
- Shockproof
- Fine adjustment
- DIN 879

Delivery

- Fitted case

**DIN
879**

☒ ☒	Measuring span	Scale graduation value	Dial reading	Overtravel	Order no.	List price
	mm	mm		mm		EUR
	0.5	0.01	25-0-25	2.5	0712 121	155.00
	0.1	0.001	50-0-50	3	0712 124	190.00



0710 Magnetic back



Model

- For dial gauges with outer ring (Bezel) Ø 58 mm
- Allows dial gauges to be used without a holder or a stand
- Magnetic force 220 N
- Cannot be used in conjunction with dial gauges 0701103 and 0701106 or any digital gauges

☒	☒	Order no.	List price EUR
		0710 101	53.00

0710 Lug back

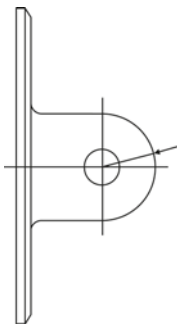

Model

- Ø 5 mm
- For retrofitting
- Cannot be used in conjunction with dial gauges 0701103 and 0701106 or any digital gauges

☒	☒	Diameter mm	Order no.	List price EUR
For dial gauges with an outer ring (Bezel) dia. 40 mm				
		5	0710 102	6.60
For dial gauges with an outer ring (Bezel) dia. 58 mm				
		5	0710 103	6.80

0710 Spindle lifting lever

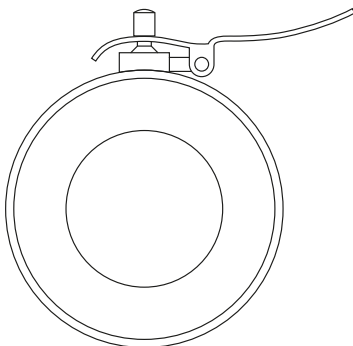

Model

- For dial gauges with a measuring span of max. 10 mm
- Cannot be used in conjunction with dial gauges 0701103 and 0701106 or any digital gauges

☒	☒	Diameter mm	Order no.	List price EUR
For dial gauges with an outer ring (Bezel) dia. 40 mm				
		5	0710 104	10.50
For dial gauges with an outer ring (Bezel) dia. 58 mm				
		5	0710 105	10.50



0724 Angle lever attachment



Model

- Clamping shank \varnothing 8 mm
- Smallest measurable hole: 6 mm
- Measuring span 10 mm

Delivery

- Excludes dial gauge
- Cardboard box

 	Measuring depth mm	Order no.	List price EUR
	60	0724 101	59.00



0710 Extensions for dial gauges

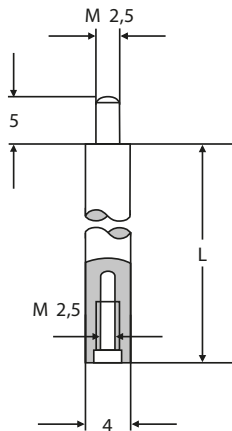

Model

- Special steel
- Thread M 2,5



 	Length mm	Order no.	List price EUR
	10	0710 111	4.50
	15	0710 112	4.50
	20	0710 113	4.50
	25	0710 114	4.50
	30	0710 115	4.50
	35	0710 116	4.50
	40	0710 117	4.50
	45	0710 118	4.50
	50	0710 119	4.50
	55	0710 120	4.50
	60	0710 121	4.50
	65	0710 122	4.50
	70	0710 123	4.50
	75	0710 124	4.50
	80	0710 125	4.50
	85	0710 126	4.50
	90	0710 127	4.50
	95	0710 128	4.50
	100	0710 129	4.50



0710 Measuring inserts M 2.5

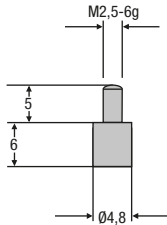

Material contact surface	Length mm	Order no.	List price EUR
Special steel	6	0710 161	4.30
Carbide	6	0710 261	29.80

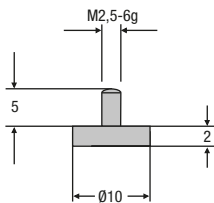

Material contact surface	Length mm	Order no.	List price EUR
Special steel	2	0710 162	5.60
Carbide	2	0710 262	48.00

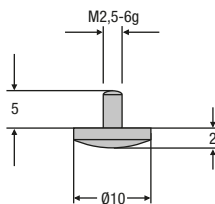

Material contact surface	Length mm	Order no.	List price EUR
Special steel	2	0710 163	6.50
Carbide	2	0710 263	75.00

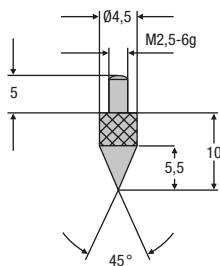

Material contact surface	Length mm	Order no.	List price EUR
Special steel	10	0710 164	6.50
Carbide	10	0710 264	56.00

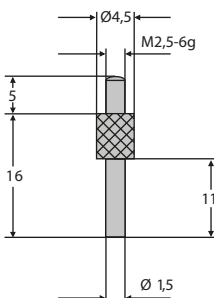

Material contact surface	Length mm	Diameter	Order no.	List price EUR
Special steel	16	1.5 mm	0710 165	8.20
Carbide	16	1.5 mm	0710 265	25.80



0710 Measuring inserts M 2.5

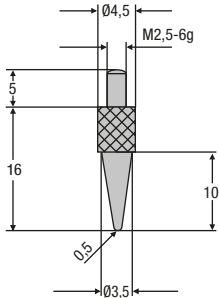

Material contact surface	Length mm	Order no.	List price EUR
Special steel	16	0710 166	5.90

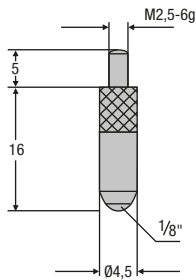

Material contact surface	Length mm	Order no.	List price EUR
Special steel	16	0710 167	4.10
Carbide	16	0710 267	13.70
Ruby	16	0710 367	10.70
Sapphire	16	0710 467	10.70

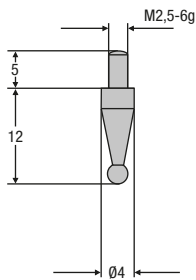

Material contact surface	Length mm	Ball diameter mm	Order no.	List price EUR
Tolerance of the ball diameter +/- 1 µm				
Special steel	12	1	0710 169	8.20
Special steel	12	1.5	0710 170	8.20
Special steel	12	2	0710 171	8.20
Special steel	12	2.5	0710 172	8.20
Special steel	12	3	0710 173	8.20
Special steel	12	3.5	0710 174	8.20
Special steel	12	4	0710 175	8.20
Special steel	12	4.5	0710 176	8.20
Special steel	12	5	0710 177	8.20
Special steel	12	5.5	0710 178	8.20
Special steel	12	6	0710 179	8.20
Special steel	12	6.5	0710 180	8.20

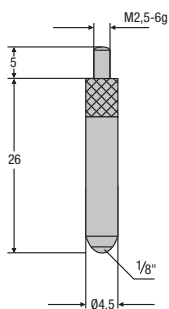

Material contact surface	Length mm	Order no.	List price EUR
Special steel	26	0710 168	4.10
Carbide	26	0710 268	13.70
Ruby	26	0710 368	10.70
Sapphire	26	0710 468	10.70



0710 Measuring inserts M 2.5

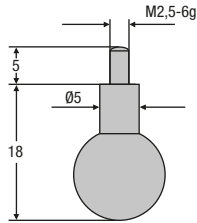

Material contact surface	Length mm	Ball diameter mm	Order no.	List price EUR
Special steel	18	7	0710 181	8.20
Special steel	18	7.5	0710 182	8.20
Special steel	18	8	0710 183	8.20
Special steel	18	8.5	0710 184	8.20
Special steel	18	9	0710 185	8.20
Special steel	18	9.5	0710 186	8.20
Special steel	18	10	0710 187	8.20
Special steel	18	10.5	0710 188	8.20
Special steel	18	11	0710 189	8.20

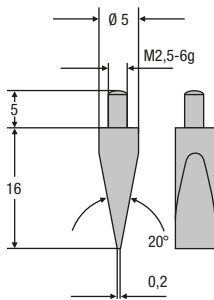

Material contact surface	Length mm	Order no.	List price EUR
With locknut			
Special steel	16	0710 192	10.10
Carbide	16	0710 292	71.00

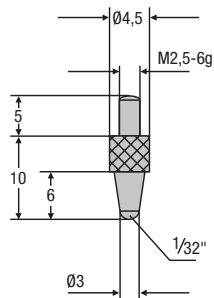

Material contact surface	Length mm	Order no.	List price EUR
Special steel	10	0710 193	4.30

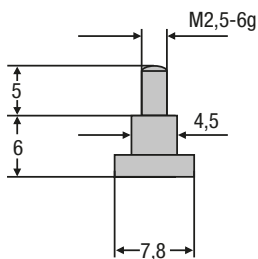

Material contact surface	Length mm	Order no.	List price EUR
Special steel	6	0710 194	5.90



0710 Measuring inserts M 2.5

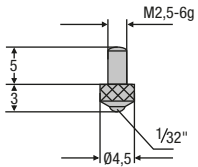

Material contact surface	Length mm	Order no.	List price EUR
Special steel	3	0710 195	1.50

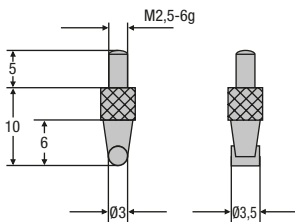

Material contact surface	Length mm	Diameter mm	Order no.	List price EUR
With locknut				
Special steel	10	3 x 3.5	0710 196	11.10

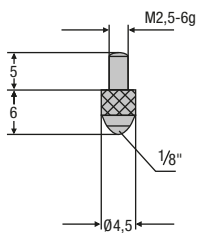

Material contact surface	Length mm	Order no.	List price EUR
Special steel	6	0710 197	1.30
Carbide	6	0710 297	5.70
Ruby	6	0710 397	8.00
Sapphire	6	0710 497	8.00



0715 Dial test indicators



0715 101



0715 201

Model

- Carbide tipped measuring inserts, Ø 2.0 mm
- Form A in accordance to DIN 2270
- Revolving dial
- 3-piece swallow tail guide
- Automatic reversal of the counting direction
- Measuring force 0.15 N

Delivery

- Fitted case

DIN
2270

⊗	☰	Measuring range mm	Scale graduation value mm	Range per rev. mm	Stylus length mm	Dial reading	Outer ring (Bezel) Ø mm	Order no.	List price EUR
		± 0.4	0.01	0.8	14.5	0-40-0	30	0715 101	80.00
		± 0.4	0.01	0.8	14.5	0-40-0	40.5	0715 103	90.00
		± 0.25	0.01	0.5	41.2	0-25-0	30	0715 201	126.00
		± 0.1	0.002	0.2	14.5	0-100-0	40.5	0715 303	113.00
		± 0.1	0.002	0.2	14.5	0-100-0	30	0715 305	107.00
		± 0.5	0.01	0.5	32.3	0-50-0	40.5	0715 307	160.00

0715 Clamping shanks for dial test indicators

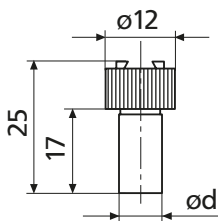

Model

- With swallow tail mounting for dial test indicators and clamping nut

⊗	☰	Diameter	Order no.	List price EUR
		4h6	0715 903	12.10
		8h6	0715 907	12.10

0715 Measuring inserts with carbide ball

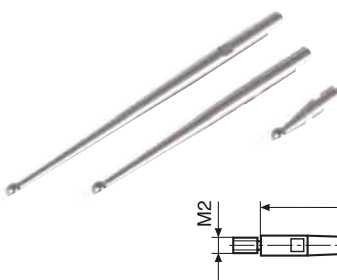

⊗	☰	Length mm	Ball diameter mm	Order no.	List price EUR
		14.5	1	0715 915	16.90
		14.5	2	0715 917	13.30
		14.5	3	0715 919	13.30
		32.3	1	0715 921	18.70
		32.3	2	0715 922	14.10
		32.3	3	0715 923	14.00
		41.2	1	0715 925	17.10
		41.2	2	0715 926	13.30
		41.2	3	0715 929	13.30



0715 Key for measuring inserts



		Order no.	List price EUR
		0715 940	2.50

0715 Universal clamp

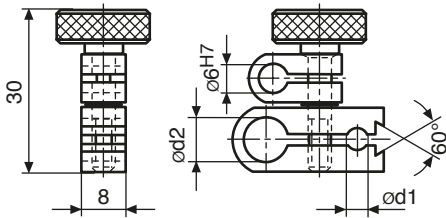

		Diameter mm	Order no.	List price EUR
		8	0715 950	25.30

0715 Holder

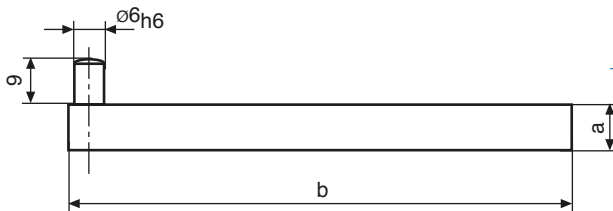

		Length mm	Cross-section mm	Order no.	List price EUR
		100	9 x 9	0715 955	16.00



0716 Dial depth gauges with a measuring base



0716 101



0716 111

Model

- Measuring base is made of stainless steel, hardened
- Replacement probe tip M 2.5
- Revolving dial
- Factory standard

Delivery

- Cardboard box

Icon	Measuring range mm	Reading mm	Contact surface mm	Range per rev. mm	Scale dia. mm	Order no.	List price EUR
	0 - 10	0.01	100 x 15	1	58	0716 101	140.00
	Concentric pointer						
	0 - 30	0.01	150 x 15	1	58	0716 102	204.00
	0 - 30	0.01	100 x 15	1	58	0716 105	183.00
	Prismatic base						
	0 - 30	0.01	for dia. 10 - 100	1	58	0716 111	270.00

0716 Depth measuring base for indicators



0716 192

Model

- Special steel, chrome plated
- Mounting for indicator Ø 8 mm

Delivery

- Cardboard box

Icon	Contact surface mm x mm	Order no.	List price EUR
	80 x 15	0716 192	59.00
	100 x 15	0716 194	73.00
	150 x 15	0716 196	94.00
	Prismatic bridge		
	for dia. 10 - 100	0716 198	125.00



0720 Foil thickness gauges



Model

- With a lifting device
- Factory standard
- Frame is made of aluminium alloy
- Revolution counter
- measuring insert dia. 6.35 mm, flat, thermally insulated

Delivery

- Cardboard box

✂	☒	Measuring range mm	Reading mm	Range per rev. mm	Throat depth mm	Order no.	List price EUR
		0 - 1	0.001	0.2	30	0720 103	243.00



0728 Internal precision bore gauges for large and deep bores



Model

- 2 point comparator measuring instrument with split probe + measuring pin
- Centering plate
- Mounting hole Ø 8 mm
- Ideal in conjunction with dial gauges or dial comparator gauges

Delivery

- Wooden case
- Without dial gauge



⌕	Measuring range	Repeatability	Measuring depth	Measuring pins	Measuring discs	Order no.	List price
	mm	µm	mm	pcs	pcs		EUR
Fixed measuring pins, hardened special steel, interchangeable contact pins are carbide tipped							
	18 - 35	0.5	110	9	2	0728 105	415.00
	35 - 60	0.5	138	7	2	0728 106	403.00
	50 - 100	0.5	177	11	3	0728 107	461.00
	100 - 160	0.5	234	7	4	0728 108	643.00
	160 - 290	0.5	234	7	4	0728 109	927.00
	280 - 510	1.5	400	7	4	0728 110	2188.00
Fixed measuring pins and interchangeable contact pins, both pins are carbide tipped							
	4.5 - 6	0.5	80	9		0728 201	1057.00
	6 - 8	0.5	100	7		0728 202	756.00
	8 - 12	0.5	100	9		0728 203	705.00
	12 - 20	0.5	110	9	1	0728 204	489.00
	18 - 35	0.5	110	9	2	0728 205	495.00
	35 - 60	0.5	138	7	2	0728 206	471.00
	50 - 100	0.5	177	11	3	0728 207	551.00
	100 - 160	0.5	234	7	4	0728 208	717.00
	160 - 290	0.5	234	7	4	0728 209	949.00
	280 - 510	1.5	400	7	4	0728 210	2240.00

0728 Setting device for internal precision bore gauges



Model

- Setting device for accurate adjustment of internal precision bore gauges to the required nominal dimension, with gauge blocks
- The setting jaws are made of carbide and are lapped to gauge block quality
- Setting device can be used in both, the vertical and horizontal measuring axis

Delivery

- Wooden case
- Incl. stand (excludes gauge blocks)

⌕	For measuring range	Error limit	Order no.	List price
	mm	µm		EUR
	4.5 - 160	2	0728 910	1307.00
	18 - 290	2	0728 915	1296.00
	160 - 510	2	0728 920	1875.00



0735 Crankshaft gauges



Model

- With dial gauge
- To be positioned between 2 crank arms
- Centre punch is not required
- Horizontal position of the dial gauge is assured with a plumb bob

Delivery

- Wooden case



⌘	⚠	Measuring range mm	Reading mm	Order no.	List price EUR
		45 - 150	0.01	0735 101	408.00
		60 - 300	0.01	0735 102	368.00
		60 - 500	0.01	0735 103	427.00

0735 Replacement gauge for 0735



Model

- Without backplate

⌘	⚠	Order no.	List price EUR
		For measuring range 45 - 150 mm	
		0735 901	225.00
		For measuring range 60 - 300 / 60 - 500 mm	
		0735 902	187.00



0739 Universal comparator gauge



3

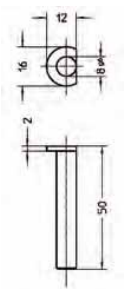

0739 124

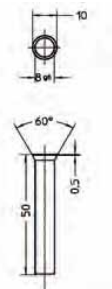

0739 126

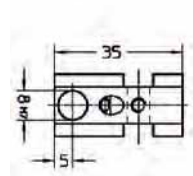

0739 164

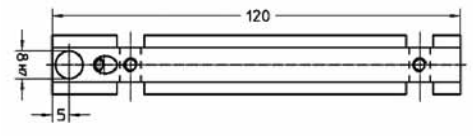

0739 165

Model

- To determine internal and external diameters of recesses, grooves and undercuts in comparison measurement
- Measurement procedure: The part to be measured is determined at the point of reversal between a fixed and moveable measuring insert
- Select either an analogue or digital indicator to show your measuring results
- Sturdy construction
- Simple to set up and easy to operate
- Large range of application
- Ideal for serial measurements
- Optional: Special supporting table is interchangeable

- Repeatability: 2 µm
- Mounting hole for a dial gauge: Ø 8 mm

Delivery

- Without digital indicator (optional)
- Incl. pair of measuring inserts 0739 126 and 0739 124
- Incl. holder for measuring inserts 0739 164 and 0739 165
- In a practical aluminium case

	Measuring range		Base dimensions	Order no.	List price
	external mm	internal mm	mm		EUR
	0 - 180	21 - 200	150 x 150 x 68	0739 102	1780.00



0739 Measuring probes

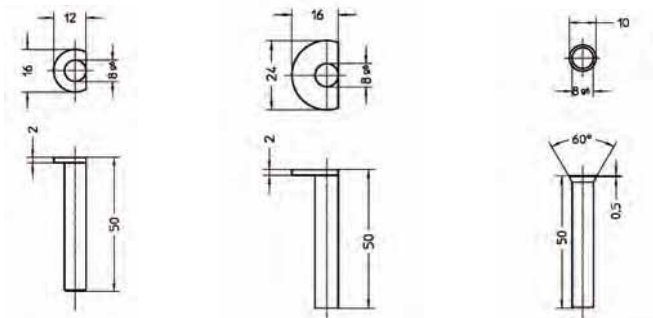

0739 124

0739 125

0739 126

	Description	Order no.	List price EUR
	Probe pair	0739 124	107.00
	Probe pair	0739 125	111.00
	Probe pair	0739 126	64.00
	Pair of probe holder	0739 127*	102.00
	Pair of probe holder	0739 128*	64.00
	Pair of probe holder	0739 129*	123.00
	Probe pair	0739 130	103.00
	Small probe pair	0739 131**	111.00
	Holder pair for 0739131	0739 132	148.00

* For further information regarding probes order no. 0739 127 to 0739 129 see order no. 0710 starting on page 137

** Required holder order no. 0739 132

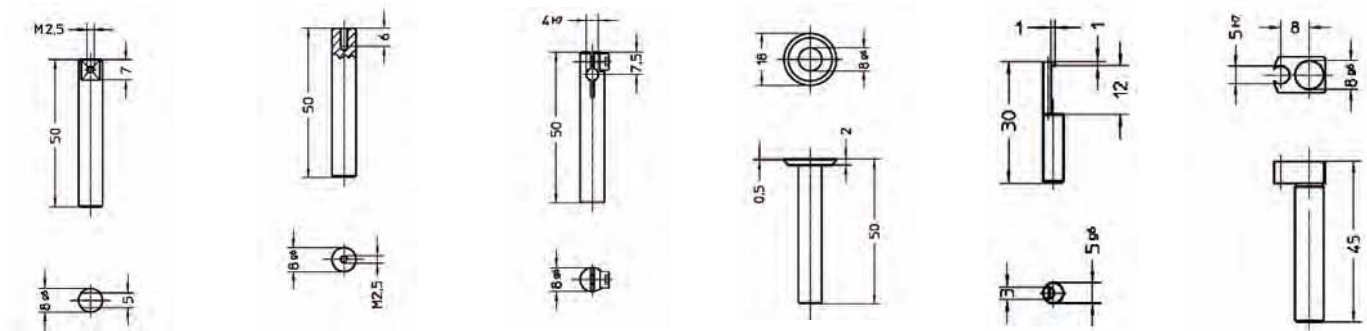

0739 127

0739 128

0739 129

0739 130

0739 131

0739 132

Application examples:

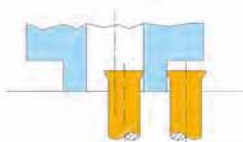

0739 126

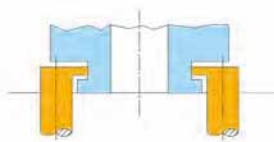

0739 124

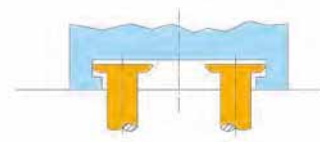

0739 130

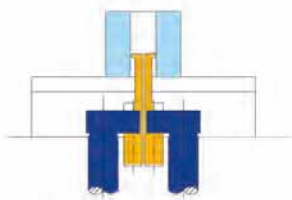

0739 131

0739 132

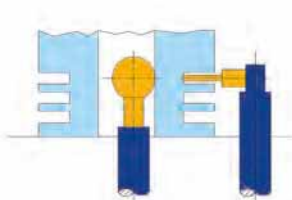

0739 127*

0739 128*

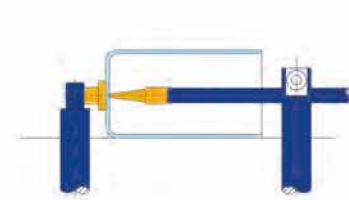

0739 129*

0739 129*



0739 Holder for measuring inserts short / long

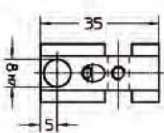

0739 164

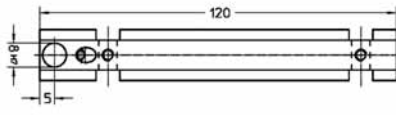

0739 165

	Description	Length mm	Order no.	List price EUR
	Holder, short	35	0739 164	38.60
	Holder, long	120	0739 165	47.60

0739 Large supporting table

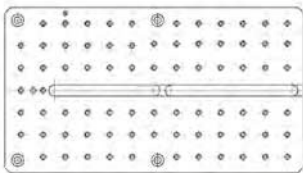

Model

- Made of special steel with wear resistant surface coating
- Equipped with thread bore M5 in grid to attach stop elements
- Internal measurement: 21 - 220 mm
- External measurement: 0 - 300 mm

Delivery

- With leg support to screw

	Size of table mm	Order no.	List price EUR
	269 x 149	0739 170	279.00

0739 Stop pieces in pairs



	Description	Length mm	Width mm	Diameter mm	Dimensions h mm	Order no.	List price EUR
	Stop cuboid	60	16		16	0739 121	91.00
	Stop disc			24	16	0739 122	103.00
	Stop stepped cuboid	60	25		16	0739 123	94.00

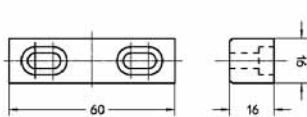

0739 121

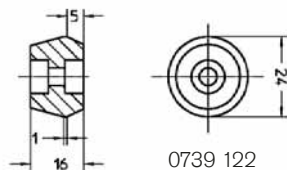

0739 122

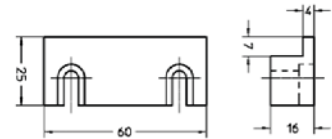

0739 123

Application examples:

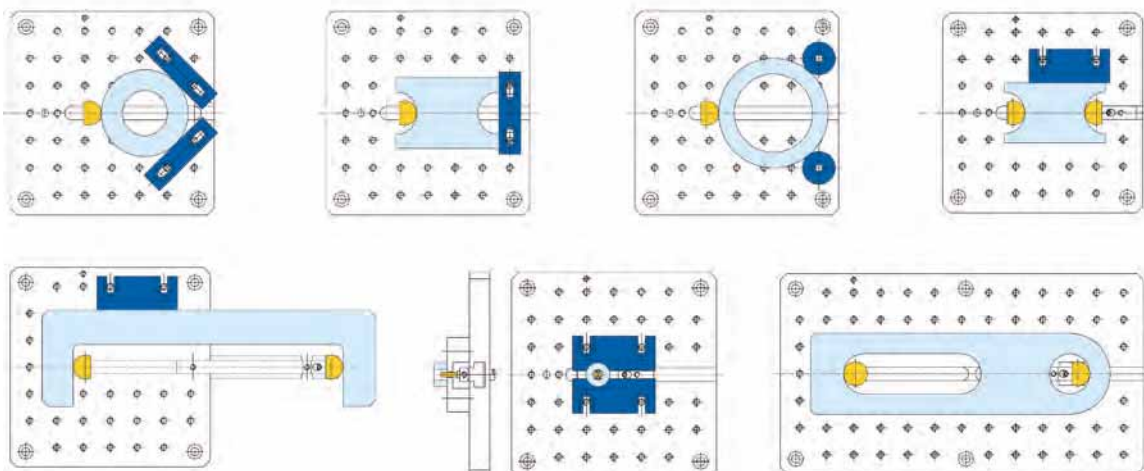



0741 Universal comparator gauge UHRTAST





0741 Comparator gauge UHRTAST



Model

- Comparator gauge for **external and internal measurements** for checking workpieces and setting of machines
- Versatile in use due to wide range of probes and inserts
- Measuring range up to 2000 mm by using optional extensions
- Without indicator
- The direction of the measuring force can be switched, the gauge can be used for external and internal measurements
- The adjustment can be conducted with a setting gauge, a combination of gauge blocks, setting ring or a micrometer
- The measuring range of the moveable measuring arm is 18 mm

Delivery

- Wooden case
- Basic instrument without digital indicator, measuring arms and measuring probes (optional)



Product video

	Measuring range		Measuring forces N	Order no.	List price EUR
	external mm	internal mm			
	5 - 220	15 - 230	external: ~6 N internal: ~4 N	0741 101	1862.00

0741 Pair of probe mounting block

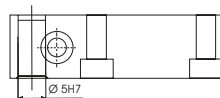

	Order no.	List price EUR
	0741 170	171.00

0741 Extensions



Model

- Combinable with the basic instrument and further extensions by sticking together the pipe construction



0741 112



0741 114

	Length mm	Order no.	List price EUR
	100	0741 112	259.00
	200	0741 114	275.00
	500	0741 116	420.00



0741 Measuring inserts



0741 178

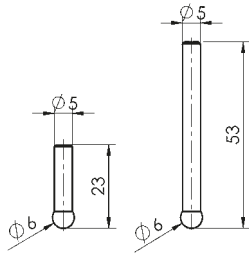

		Length	Diameter	Order no.	List price
		mm	mm		EUR
		23	6	0741 178	115.00
		53	6	0741 179	115.00

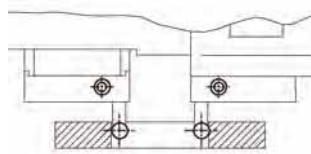

0741 Measuring inserts

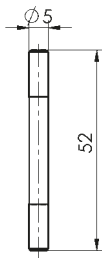

		Length	Diameter	Order no.	List price
		mm	mm		EUR
		52	5	0741 180	115.00

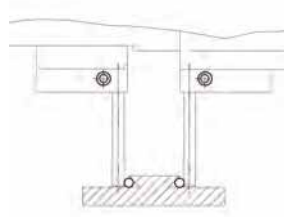

0741 Pair of offset measuring inserts

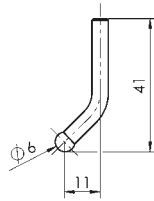

		Length	Diameter	Order no.	List price
		mm	mm		EUR
		41	6	0741 182	191.00

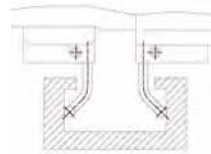



0741 Measuring inserts

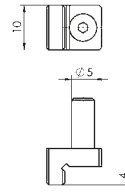
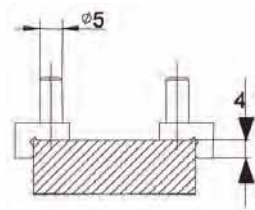

Model

- For measuring external central points

	Order no.	List price
	0741 172	EUR 204.00

0741 Pair of shoulder measuring inserts

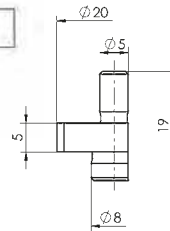
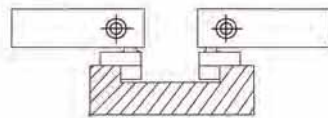

Model

- For measuring internal central points

	Order no.	List price
	0741 174	EUR 167.00

0741 Pair of measuring inserts with discs

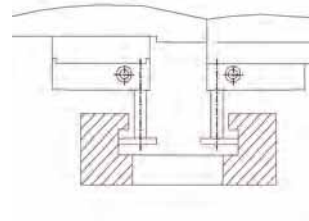
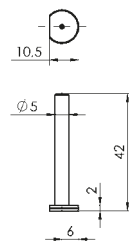

	Length	Width	Diameter	Dimensions h	Order no.	List price
	mm	mm	mm	mm		EUR
	42	10.5	12	2	0741 176	115.00



0741 Pairs of measuring arms

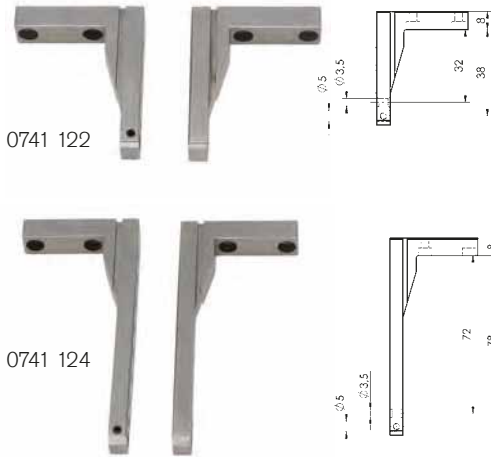

Model

- For mounting of adapter pieces and inserts with shaft- \varnothing 3.5 mm and \varnothing 5 mm
- With lasered help rule (mm-divide) as position help for the depth stop pieces

	Length mm	Order no.	List price EUR
	40	0741 122	270.00
	80	0741 124	324.00

0741 Pair of depth stop attachment for measuring arms

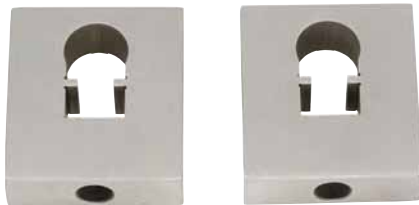

Model

- To slide on measuring arms
- Can be clamped with grub screw

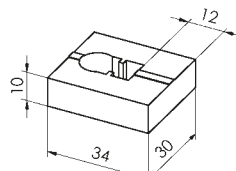

	Length mm	Width mm	Height mm	Order no.	List price EUR
	34	30	10	0741 136	251.00

0741 Pair of adapters 5 mm for measuring inserts M2.5



Model

- All measuring inserts for dial gauges with M2.5 can be used (measuring inserts please refer to pages 137-140)

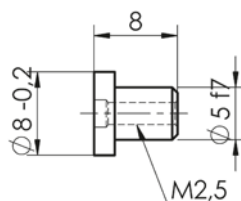

	Order no.	List price EUR
	0741 132	88.00



0741 Pair of adapters for thread measuring inserts (pair)

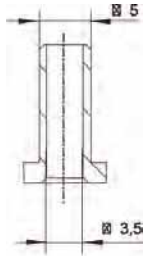

Model

- Pair of adapters for thread measuring inserts with long shanks (length 13.5 mm)
Adapters are not required for measuring inserts with short shanks

Order no.	List price
0741 134	EUR 152.00

0741 Measuring table



Model

- Consisting of:
Supporting table ø 180 mm
Measuring probe
Mounting stands

Delivery

- Cardboard box

Size of table	Order no.	List price
mm ø 180	0741 184	EUR 649.00



0753 Universal indicator stands with magnetic base



0753 110



0753 120

Model

- Chrome finished columns
- Base with V-groove
- Magnet with ON/OFF switch
- Mounting clamp: Ø 8 mm for indicators
- Integrated fine adjustment

Delivery

- Cardboard box

✕	🏠	Projection	Column height	Column dia.	Arm dia.	Base dimensions	Magnetic force	Order no.	List price
		mm	mm	mm	mm	mm	N		EUR
		140	230	16	12	60 x 50 x 55	500	0753 110	24.90
		180	285	16	16	70 x 46 x 65	600	0753 120	61.00



0750 Universal indicator stands with magnetic base and combi clamp



0750 101

Model

- Chrome plated columns
- Base with V-groove
- Magnet with ON/OFF switch
- **Combi clamp:** Ø 8 mm for dial gauges, swallow tail clamp for dial test indicators
- Intergrated fine adjustment

Delivery

- Cardboard box

Accessories

	Order no.	List price EUR
Replacement crosshead complete	0750 113	42.00
Wooden case for magnet - measuring support	0750 601	25.10

☒	☒	Projection mm	Column height mm	Column dia. mm	Arm dia. mm	Base dimensions mm	Magnetic force N	Order no.	List price EUR
Crosshead clamp									
		180	500	20	16	75 x 60 x 102	800	0750 102	187.00

0750 Pillar with transverse arm and fine adjustment



Model

- Chrome plated column and transverse arm
- Mounting for indicator:
 - shank mounting Ø 8 mm for dial gauges
 - swallow tail clamp for dial test indicators
- Integrated fine adjustment

☒	☒	Thread	Projection mm	Column height mm	Column dia. mm	Arm dia. mm	Description	Order no.	List price EUR
		M12	180	500	20	16	for 0750 102	0750 122	96.00

0750 Magnetic base



0750 111

Model

- Magnetic base with V-groove
- Cling to flat and cylindric parts
- Magnetic force can be switched On / Off by rotary switch

☒	☒	Thread	Base dimensions mm	Magnetic force N	Order no.	List price EUR
		M12	75 x 60 x 80	800	0750 112	109.00



0752 Magnetic indicator stands with central lock



0752 101



0752 103

Model

- Column / Arm:
 - 0752 101 steel, chrome finished
 - 0752 103 aluminium, anodized
- Switch magnetic base with V-groove
- Central magnetic clamping system

- **Combi clamp:** Ø 8 mm for dial gauges, swallow tail clamp for dial test indicators
- Intergrated fine adjustment

Delivery

- Cardboard box

☒	☒	Projection mm	Column height mm	Column dia. mm	Base dimensions mm	Magnetic force N	Order no.	List price EUR
		260	310	10	70 x 46 x 65	600	0752 101	144.00
		320	370	18	70 x 46 x 65	600	0752 103	184.00



0754 Universal magnetic holder



Model

- Magnetic base with V-groove
- With mounting hole Ø 8 mm
- Three-sided magnet

Delivery

- Cardboard box

	Max. height mm	Base dimensions mm	Magnetic force N	Order no.	List price EUR
	57	70 x 35	260	0754 101	99.00

3

0756 Universal magnetic holder



Model

- Cast iron base with two magnets on the bottom of the holder
- With mounting hole Ø 8 mm

Delivery

- Cardboard box

	Max. height mm	Base dimensions mm	Magnetic force N	Order no.	List price EUR
	45	72 x 37	180	0756 101	59.00



0770 Compact measuring stands



0770 102



0770 103



0770 201

Model

- Cast base
- Chrome finished columns
- Hardened steel table
- With dust grooves (Order No. 0770 102 non-stop plane)
- With mounting hole for dial gauges \varnothing 8 mm

Delivery

- Cardboard box

		Measuring height mm	Projection mm	Size of table mm	Column dia. mm	Arm dia. mm	Order no.	List price EUR
With fixed arm								
		100	49	\varnothing 50	22	-	0770 102	208.00
		100	49	60 x 68	22	-	0770 103	241.00
With adjustable transverse arm								
		100	100	60 x 68	22	18	0770 201	266.00
		150	135	98 x 115	28	20	0770 205	377.00



0772 Measuring stand



Model

- Cast base
- Hardened steel table
- With dust grooves
- With a threaded column and an adjustable transverse arm
- With mounting hole for dial gauges Ø 8 mm

Delivery

- Cardboard box

☒	☒	Measuring height	Projection	Size of table	Column dia.	Arm dia.	Order no.	List price
		mm	mm	mm	mm	mm		EUR
		160	200	170 x 215	35	22	0772 024	759.00

0785 Precision measuring stands



Model

- Base made of hard stone
- Base plate accuracy according to DIN 876-00
- With a threaded column
- With adjustable transverse arm
- With mounting hole for dial gauges Ø 8 mm
- Vertical adjustment by threaded spindle with setting ring

Delivery

- Cardboard box

☒	☒	Measuring height	Projection	Size of table	Column dia.	Arm dia.	Order no.	List price
		mm	mm	mm	mm	mm		EUR
		200	200	150 x 260	35	22	0785 108	639.00
	▪	220	220	300 x 350	35	22	0785 109	1565.00
		Anti-twist (secured against rotation) transverse arm						
	▪	220	220	300 x 350	35	22	0785 110	1800.00



0763 Universal measuring support



Model

- Column and transverse arm chrome plated
- Column is moving and can be clamped in the T-groove
- Heavy base plate with prismatic base and T-groove
- Mounting for display devices:
 - support for indicators with shaft \varnothing 8 mm, swallow tail clamp for dial test indicators
- Integrated fine adjustment

Delivery

- Cardboard box

	Projection	Column height	Column dia.	Arm dia.	Base dimensions	Order no.	List price
	mm	mm	mm	mm	mm		EUR
	180	300	16	16	250 x 60 x 35	0763 100	279.00



0780 Bench centres

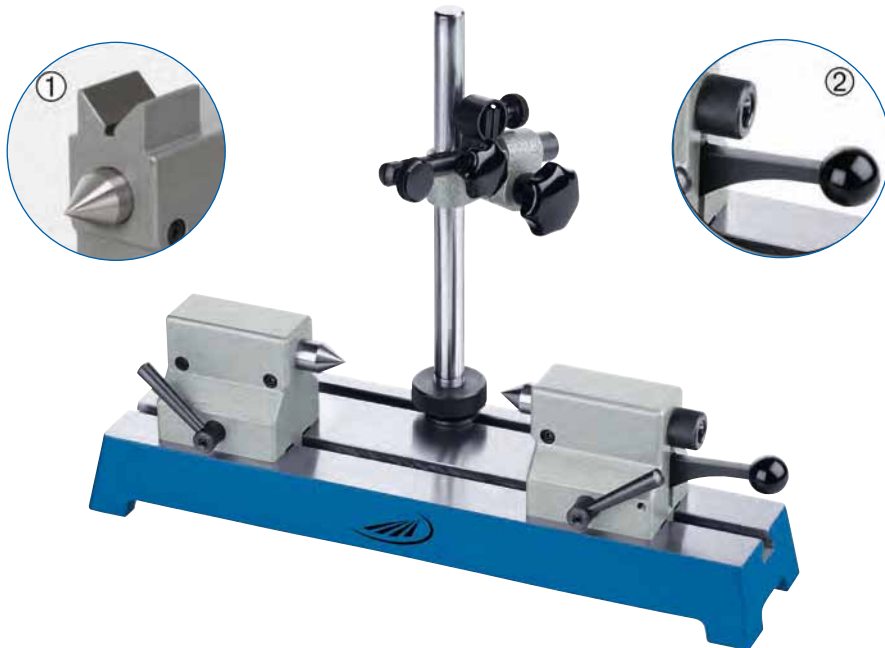

3

Model

- Finely ground surface, flatness tolerance according to DIN 876-2
- With two adjustable tailstocks
- Left tailstock with fixed centre
- Right tailstock with retractable spring mounted centre, free lift appr. 10 mm

Delivery

- Tailstocks can be clamped via an eccentric clamp
- Tailstock height 75 mm with integrated V-groove support
- Quick-clamping device by clamping lever
- With T-groove and support column
- With mounting hole for dial gauges \varnothing 8 mm

▶	☒	Height of centers	Workpiece load	Distance between centres	Center dia.	T-groove width	Base	Order no.	List price
		mm	p. tailstock max. kg	mm	mm	mm	mm		EUR
		50	5	200	16	10H7	350 x 110	0780 101	605.00
		50	5	350	16	10H7	500 x 110	0780 102	768.00
		75	5	200	16	10H7	350 x 110	0780 104*	692.00
		75	5	350	16	10H7	500 x 110	0780 105*	788.00
	▪	100	20	450	22	12H7	700 x 180	0780 107	1984.00
	▪	150	20	450	22	12H7	700 x 180	0780 108	2212.00

* With integrated V-groove support on the tailstocks for \varnothing 6 - 24 mm

Accessories

	Order no.	List price EUR
Replacement centre, retractable, \varnothing 16 mm (50 - 75 mm)	0780 174	49.00
Replacement centre, fixed, \varnothing 16 mm (50 - 75 mm)	0780 175	39.00
Replacement centre, retractable, \varnothing 22 mm (100 - 150 mm)	0780 177	125.00
Replacement centre, fixed, \varnothing 22 mm (100 - 150 mm)	0780 178	115.00



0780 Bench centres with roller supports



Specification

- Finely ground surface, flatness tolerance according to DIN 876-2
- With two roller supports
- Concentricity tolerance of the rolls 0.005 mm
- Quick-clamping device by clamping lever
- With T-groove and support column
- With mounting hole for dial gauges Ø 8 mm
- Fine adjustment

Delivery

- Cardboard box

Marked *	Marked *	Height of roller supports	T-groove width	Base	Contact surface	Order no.	List price
		mm	mm	mm	mm		EUR
		65	10H7	350 x 110	3 - 30	0780 201	559.00
		65	10H7	500 x 110	3 - 30	0780 202	699.00
		100	12H7	700 x 180	4 - 60	0780 206	1400.00



0780 Bench centres with V-groove supports



Specification

- Finely ground surface, flatness tolerance according to DIN 876-2
- With two V-supports
- Quick-clamping device by clamping lever
- Prismatic contact surface 90°
- V-groove surfaces made of hardened steel (replaceable)
- With T-groove and support column
- With mounting hole for dial gauges Ø 8 mm
- Fine adjustment

Delivery

- Cardboard box

Icon	Height of V-supports mm	T-groove width mm	Base mm	Contact surface mm	Order no.	List price EUR
☒	65	10H7	350 x 110	5 - 25	0780 301	529.00
☒	65	10H7	500 x 110	5 - 25	0780 302	669.00
☒	100	10H7	700 x 180	5 - 50	0780 306	1340.00



0780 Bench centres for heavy workpieces



Model

- Finely ground surface, flatness tolerance according to DIN 876-2
- With two adjustable tailstocks
- Left tailstock with fixed centre
- Right heavy tailstock with moveable, spring mounted centre, free lift appr. 10 mm
- Tighten by hand crank
- Tailstock can be clamped via an eccentric clamp
- Base made of cast iron with T-groove
- Measuring stand with mounting hole for dial gauges Ø 8 mm

Delivery

- Cardboard box

✕	☒	Height of centers	Workpiece load p. tailstock max.	Distance between centres	Centering tip dia.	T-groove width	Base	Order no.	List price
		mm	kg	mm	mm	mm	mm		EUR
	▪	100	40	450	22	12	700 x 180	0780 141	2116.00
	▪	150	40	450	22	12	700 x 180	0780 142	2395.00

0780 Pair of v-support inserts



Model

- V-support inserts to place in and for testing of shafts without centrebores
- V-support inserts are exchanged for the pointed alignment centre of the tailstocks

✕	☒	For height of centers	Max. workpiece dia.	Contact surface	Order no.	List price
		mm	mm	mm		EUR
		50/75	15	3 - 15	0780 021	109.00
		100	45	8 - 45	0780 023	139.00

0780 Replacement support column



Model

- Column is moving and can be clamped in the T-groove
- Mounting for indicator:
 - shaft mounting Ø 8 mm for dial test indicators
- Integrated fine adjustment

✕	☒	For height of centers	Projection	T-groove width	Column height	Column dia.	Arm dia.	Order no.	List price
		mm	mm	mm	mm	mm	mm		EUR
		50/75	105	10	200	18	14	0780 072	129.00
		100	105	12	240	18	14	0780 073	235.00
		150	105	12	440	18	14	0780 074	259.00



0780 Left tailstocks with a rotating collet chuck



Model

- The left tailstock can be changed because of this specification with a collet chuck
- The collet chuck is rotatable for runout testing
- T-grooves bearing
- Eccentric clamp

☒	☒	Height of centers mm	T-groove width mm	Order no.	List price EUR
For collet chucks type F10 (Ø 1 - 7 mm)					
		50	10	0780 001	376.00
		75	10	0780 002	417.00
For collet chucks type F14 (Ø 1 - 10 mm)					
		100	12	0780 003	649.00

- Collet chucks F10 from 1-7 mm are available upon request
- Collet chucks F14 from 1-10 mm are available upon request

Pair of replacement tailstocks for 0780

Model

- Included in base model 0780
- 75 mm with intergrated V-groove support
- For heavy workpieces with load up to 40 kg on request

☒	☒	Height of centers mm	Workpiece load p. tailstock max. kg	T-groove width mm	Order no.	List price EUR
		50	5	10	0780 091	380.00
		75	5	10	0780 092	427.00
		100	20	12	0780 093	879.00
		150	20	12	0780 094	909.00

Pair of V-groove supports for 0780



Model

- For workpieces without centering
- Functional test through applying on e.g. plain lateral surface
- Recognition of form errors
- For exchange of centre supports
- Prismatic contact surface 90°
- V-groove surfaces made of hardened steel (replaceable)
- T-grooves bearing
- Eccentric clamp

☒	☒	Height of centres* mm	Height of V-supports mm	T-groove width mm	Contact surface mm	Order no.	List price EUR
		65	65	10	5 - 25	0780 032	199.00
		100	100	12	5 - 50	0780 033	275.00

* based on the center of an axis of a shaft Ø 10 mm

Pair of roller supports for 0780



Model

- For exchange of centre supports
- Ball bearing rollers for easy turning of the workpieces
- Concentricity tolerance 0.005 mm

☒	☒	Height of roller supports* mm	T-groove width mm	Contact surface mm	Order no.	List price EUR
		65	10	3 - 30	0780 042	193.00
		100	12	4 - 60	0780 043	261.00

* based on the center of an axis of a shaft Ø 10 mm



0783 Bench centre



DIN
876-1



Model

- Dark granite work bench
- Flatness tolerance in accordance to DIN 876-1
- Right tailstock with retractable spring mounted centre (quick adjustment lever)
- Left tailstock with fixed centre
- Tailstocks can be adjusted via an eccentric clamp

Delivery

- Wooden handling case
- Included:
 - Work bench
 - Support post
 - 1 pair of tailstocks with pointed alignment centre 60° MK 2

☒	☒	Height of centers mm	Workpiece load p. tailstock max. kg	Distance between centres mm	T-groove width mm	Base mm	Order no.	List price EUR
▪		200	24	650	14	1100 x 180	0783 012	3545.00

Accessories	Order no.	List price EUR
Pair of pointed alignment centres	0782 181	225.00
Tailstock	0782 191	1172.00
Measuring support	0783 070	296.00

0782 Pair of roller supports



Model

- For exchange of centre supports
- Ball bearing rollers for easy turning of the workpieces
- T-grooves bearing
- Eccentric clamp

☒	☒	Height of roller supports mm	T-groove width mm	Contact surface mm	Order no.	List price EUR
		200	14	25 - 100	0782 160	706.00



0784 Concentricity measuring gauge with disc supports

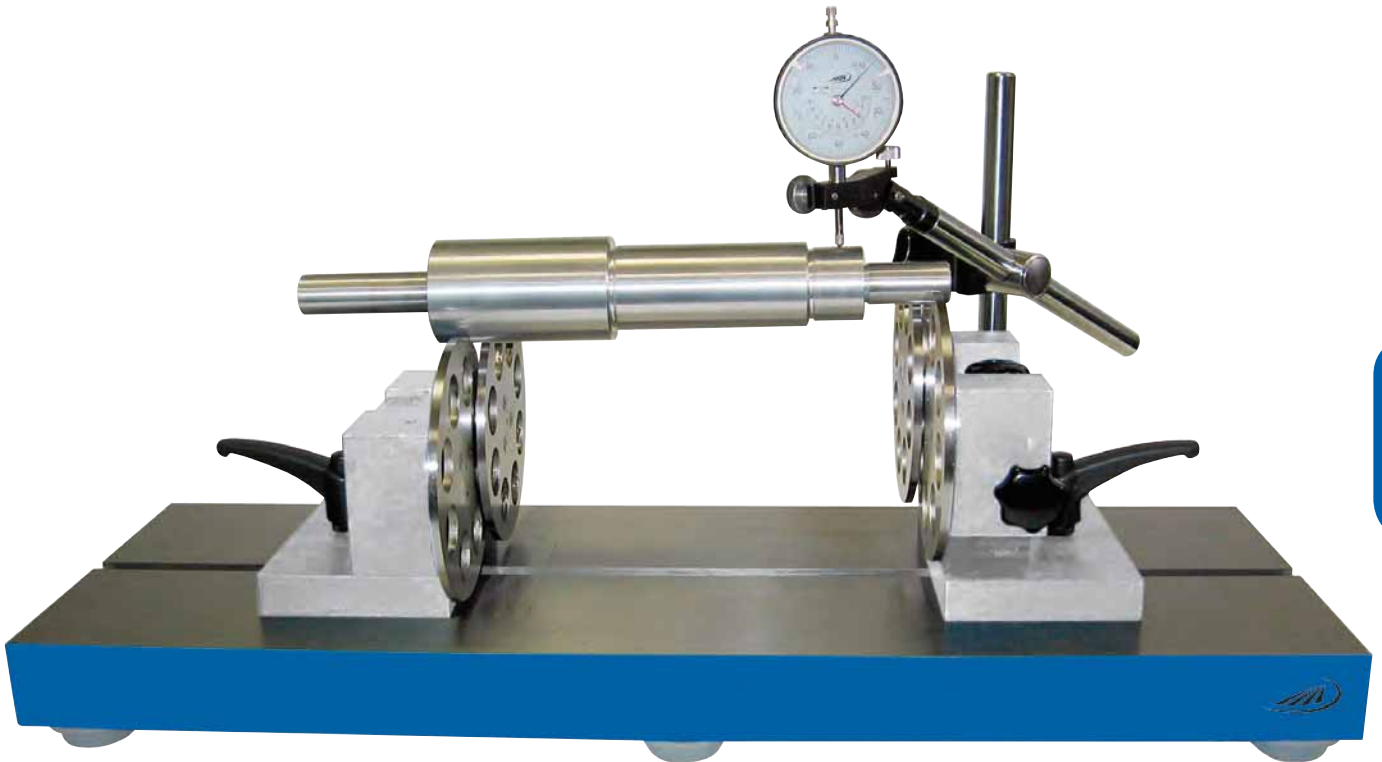

3

Model

- Centerless concentricity measuring instrument
- High accuracy discs are being mounted on bearings; free of play
- Discs can be slid to either side on the base

Delivery

- One sliding disc can be adjusted up to 30 mm for diametral compensation
- Concentricity accuracy < 5 µm
- Wooden case
- Includes the support stand, excludes a dial gauge

Workpiece load p. tailstock max. kg	Distance between the end mm	Disc diameter mm	Max. workpiece dia. mm	Order no.	List price EUR
25	400	120	250	0784 108	3101.00

Accessories

Accessories	Order no.	List price EUR
Replacement discs, pair, Ø 120 mm	0784 181	625.00
Complete support stand for order no. 0784 108	0784 190	175.00



0788 Shaft measuring instrument



Model

- For rapid measurement of diameters, distances, shoulders, taper, roundness, etc.
- For vertical and horizontal alignment
- Vertical base with 3 hardened adjustment support surfaces
- Measuring beam is made of stainless steel
- Load capacity horizontal max. 20 kg

Delivery

- Cardboard box
- Without measuring support, guideway, dial gauge (optional accessories)



application as a bench centre

✕	📏	Height of centers	Distance between centres	T-groove width	Base	Order no.	List price
		mm	mm	mm	mm		EUR
▪		75	550	10 H7	200 x 120	0788 104	1131.00
Accessories						Order no.	List price
Support arm with guideways						0788 180	EUR 229.00



0788 180



0788 Shaft measuring instrument lightweight



Model

- For rapid measurement of distances, shoulders, taper, roundness, etc.
- Vertical and horizontal alignment
- Vertical base with 3 hardened adjustment support surfaces
- Measuring beam is made of hard anodized aluminium profile
- Aluminium tailstocks
- Load capacity horizontal max. 15 kg

Delivery

- Cardboard box
- Without measuring support, guideway, dial gauge (optional accessories)



application as a bench centre

3

Height of centers	Distance between the end	T-groove width	Base	Order no.	List price
mm	mm	mm	mm		EUR
75	550	10 H7	200 x 150	0788 904	900.00
Accessories				Order no.	List price
					EUR
Support arm with holder				0788 980	73.00
Support arm with guideways				0788 990	326.00



0788 980



0788 990



SAMPLES MARKING GAUGES

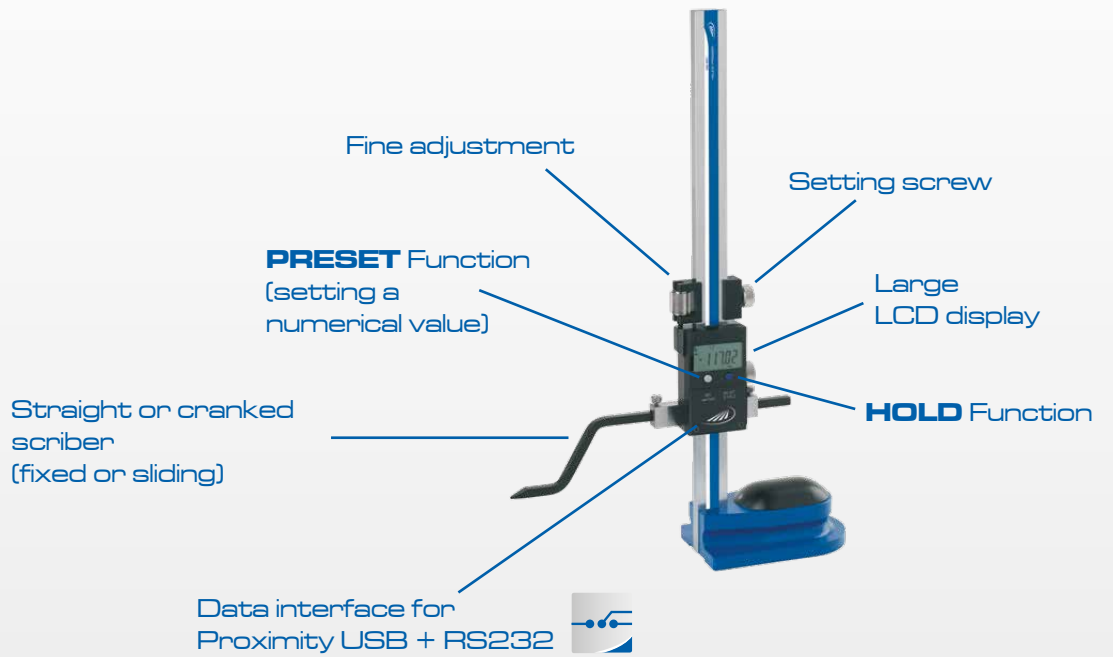
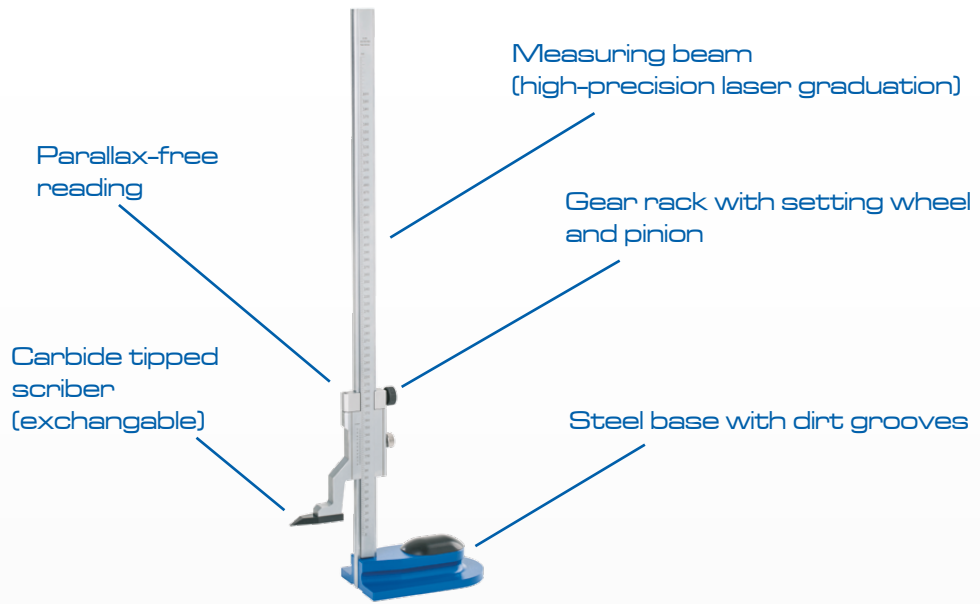

More products from our range of **Marking gauges**



MARKING **GAUGES**



DIVIDERS



MARKING **CALIPERS**

4. CHAPTER MARKING GAUGES

162	Scribers
163	Dividers
164	Internal and external calipers
167	Marking calipers / Marking gauges
170	Height and scribing gauges





0300 Scribes



		Length mm	Material	Order no.	List price EUR
With straight screw-in scribe					
		175	Chromium-vanadium steel, hardened	0300 007	2.10
With one straight and one L-shaped screw-in scribe					
		250	Chromium-vanadium steel, hardened	0300 008	2.30
With one straight and one angled screw-in and burnished scribe					
		200	Chromium-vanadium steel, hardened	0300 011	2.10
		250	Carbide-tipped	0300 114	8.80
With a mechanic and pocket clip					
		150	Carbide-tipped	0300 120	12.80
One piece hexagonal body with a pocket clip					
		180	Carbide-tipped	0300 102	5.60
For scribe 0300 008, with straight scribe, plastic handle					
		110	Carbide-tipped	0300 112	4.70

0300 Replacement scribes



		Length mm	Material	Order no.	List price EUR
For scribes 0300 007, 0300 008, straight					
		86	Chromium-vanadium steel, hardened	0300 009	1.10
For scribe 0300 008, L-shaped					
		80	Chromium-vanadium steel, hardened	0300 010	1.10
For scribe 0300 120					
		33	Carbide-tipped	0300 130	3.40



0301 Precision dividers



Model

- With a rivetted hinge
- Hardened needle, shaped ground points
- Special steel

Delivery

- Cardboard box

✂	☒	Length mm	Order no.	List price EUR
		150	0301 001	7.30
		175	0301 002	8.30
		200	0301 003	9.20
		250	0301 004	12.80
		300	0301 005	15.50
		400	0301 006	41.90
		500	0301 007	59.00
		600	0301 008	78.00
		800	0301 009	109.00
		1000	0301 010	160.00

0302 / 0306 Dividers with quadrant



Model

- With a rivetted hinge
- Special steel
- Quadrant with robust, milled locking screw
- Hardened points

Delivery

- Cardboard box

✂	☒	Length mm	Order no.	List price EUR
		150	0302 001	10.70
		175	0302 002	11.80
		200	0302 003	12.60
		250	0302 004	16.50
		300	0302 005	21.60
		400	0302 006	60.00
		500	0302 007	74.00
		600	0302 008	95.00
		800	0302 009	132.00
		1000	0302 010	183.00
With pencil holder				
		150	0306 001	13.70
		200	0306 003	15.50
		300	0306 005	24.20



0303 Precision internal calipers





Model

- With a rivetted hinge
- Special steel
- Hardened measuring points

Delivery

- Cardboard box

 	Length mm	Order no.	List price EUR
	150	0303 001	7.10
	175	0303 002	7.70
	200	0303 003	8.80
	250	0303 004	9.40
	300	0303 005	10.70
	400	0303 006	13.10
	500	0303 007	16.30
	600	0303 008	24.60
	800	0303 009	35.40
	1000	0303 010	65.00

0304 Precision external calipers





Model

- With a rivetted hinge
- Special steel
- Hardened measuring points

Delivery

- Cardboard box

 	Length mm	Order no.	List price EUR
	150	0304 001	7.10
	175	0304 002	7.70
	200	0304 003	8.80
	250	0304 004	9.40
	300	0304 005	10.70
	400	0304 006	13.10
	500	0304 007	16.30
	600	0304 008	24.60
	800	0304 009	35.40
	1000	0304 010	65.00



0310 Spring dividers



Model

- Quick release set screw
- Special steel
- Fixed points
- Hardened points
- Quick release set screw and spring are burnished

Delivery

- Cardboard box

☒	☒	Radius mm	Order no.	List price EUR
		115	0310 102	4.00
		140	0310 103	4.40
		190	0310 105	4.90
		240	0310 107	6.30
		290	0310 108	7.40

0311 Spring dividers



Model

- Quick release set screw
- Special steel
- Interchangeable points
- Hardened points
- Quick release set screw and spring are burnished

Delivery

- Cardboard box

☒	☒	Radius mm	Order no.	List price EUR
		90	0311 101	4.30
		115	0311 102	5.00
		140	0311 103	5.90
		190	0311 105	7.00
		240	0311 107	8.50
		290	0311 108	9.10

0311 Pair of replacement points for spring dividers



☒	☒	Material	Order no.	List price EUR
		Special steel, hardened	0311 120	2.30
		Carbide-tipped	0311 121	19.10



0312 Spring internal calipers



Model

- Internal caliper with quick release set screw
- Special steel
- Quick release set screw and spring are burnished

Delivery

- Cardboard box

		Length mm	Order no.	List price EUR
		100	0312 101	3.40
		150	0312 103	4.90
		200	0312 105	5.90
		250	0312 107	7.30
		300	0312 108	8.80

0313 Spring external calipers



Model

- External caliper with quick release set screw
- Special steel
- Quick release set screw and spring are burnished

Delivery

- Cardboard box

		Length mm	Order no.	List price EUR
		100	0313 101	3.40
		150	0313 103	4.90
		200	0313 105	5.90
		250	0313 107	7.30
		300	0313 108	8.80



0308 Combined internal / external calipers



Model

- Internal and external caliper
- Stainless steel
- Satin chrome finished scale
- With a rivetted hinge
- mm graduation for internal and external measurement

Delivery

- Cardboard box

☒	☒	Length mm	Measuring range mm	Order no.	List price EUR
		190	0 - 120	0308 201	94.00
		250	0 - 160	0308 202	113.00
		310	0 - 200	0308 303	138.00
		460	0 - 300	0308 305	163.00

0322 Marking gauges with guide roll



Model

- Stainless steel, hardened
- Reading parts are satin chrome finished
- Guide roll
- Locking screw
- Interchangeable scriber made of hardened steel
- Factory standard

Delivery

- Cardboard box

☒	☒	Measuring range mm	Reading mm	Order no.	List price EUR
		0 - 200	0.1	0322 501	25.90
		0 - 400	0.1	0322 503	40.60

Accessories

	Order no.	List price EUR
Replacement scribers ø 2 mm	0322 510	4.60



0343 Marking calipers

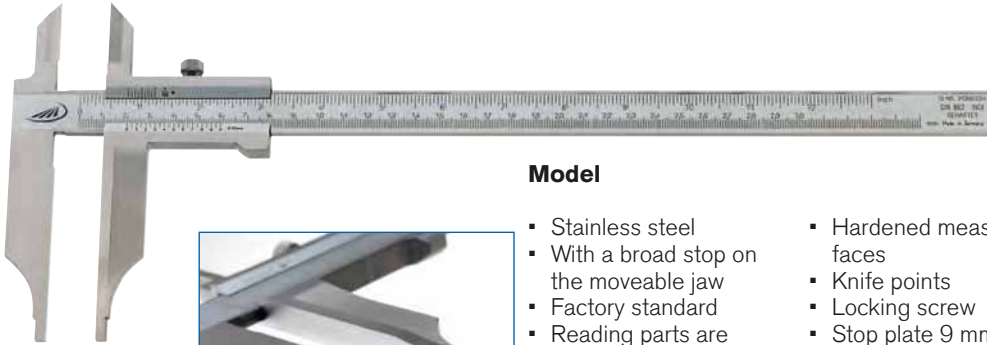

Model

- Stainless steel
- With a broad stop on the moveable jaw
- Factory standard
- Reading parts are satin chrome finished
- Hardened measuring faces
- Knife points
- Locking screw
- Stop plate 9 mm

Delivery

- Cardboard box

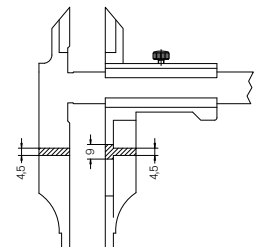

Measuring range	Reading	Rail cross-section	Jaw length	Jaws for inside measurements	Order no.	List price
mm	mm	mm	mm	mm		EUR
0 - 250	0.05	20 x 5	90	10	0343 501	266.00
0 - 300	0.05	20 x 5	90	10	0343 503	299.00

0344 Marking calipers

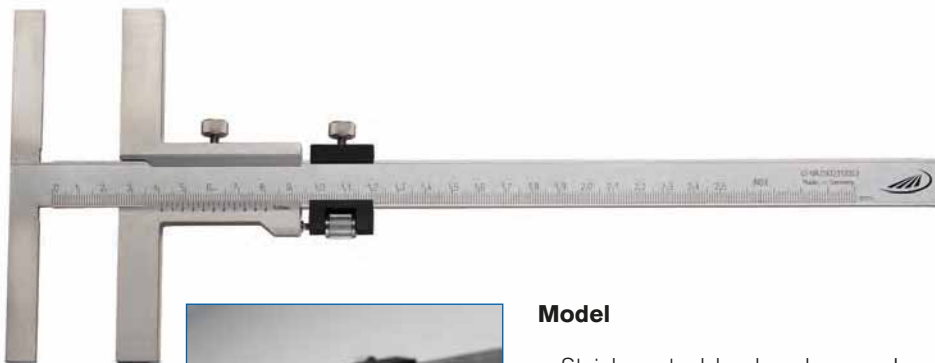

Model

- Stainless steel, hardened
- Long T-shaped marking edge
- Factory standard
- Reading parts are satin chrome finished
- Low set master scale
- Fine adjustment
- Locking screw

Delivery

- Cardboard box

Measuring range	Reading	Rail cross-section	Length of edge	Order no.	List price
mm	mm	mm	mm		EUR
0 - 160	0.05	18 x 4	135	0344 501	130.00
0 - 250	0.05	18 x 4	135	0344 502	166.00
0 - 300	0.05	18 x 4	160	0344 503	210.00
0 - 500	0.05	18 x 4	160	0344 505	446.00



0321 Marking gauges

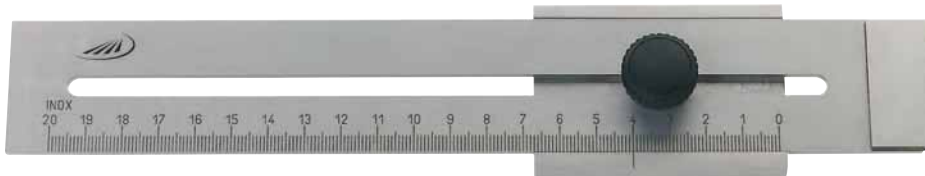

Model

- Flat, stable construction
- Stainless steel, chrome finished
- Locking screw
- Hardened stop face
- mm graduated scale
- Factory standard

Delivery

- Cardboard box

☒ ☒	Measuring range mm	Reading mm	Rail cross-section mm	Order no.	List price EUR
	0 - 200	0.1	40	0321 301	22.70
	0 - 250	0.1	40	0321 302	25.40
	0 - 300	0.1	40	0321 303	25.90
	0 - 500	0.1	40	0321 305	49.30

0323 Marking gauges



Model

- Stainless steel
- Locking screw
- For marking by scale as well as for marking of 45° - or 90° - mitres
- mm graduation
- Factory standard

Delivery

- Cardboard box

☒ ☒	Measuring range mm	Reading mm	Rail cross-section mm	Order no.	List price EUR
	100	1	40	0323 308	16.90
	200	1	40	0323 318	21.60



0345 / 0347 Analogue height and scribing gauges



0345 530

0347 530

Model

- Measuring beam is made from stainless steel
- Vernier and scale are satin chrome finished
- Parallax-free reading
- Setting screw
- Fine adjustment
- Accurate fine adjustment on gear rack and setting wheel with pinion
- Steel base with dirt grooves
- Scribing possible from base plate level
- Factory standard

Delivery

- With exchangeable scribe, carbide tipped, 75 mm



② Fine adjustment on gear rack

☒	☒	Measuring range mm	Reading mm	Base dimensions mm	Rail cross-section mm	Order no.	List price EUR
With fine adjustment							
		0 - 300	0.02	145 x 90 x 44	30 x 12	0345 522	389.00
		0 - 600	0.02	189 x 118 x 44	30 x 12	0345 530	487.00
		0 - 1000	0.02	228 x 124 x 44	30 x 12	0345 534	670.00
With pinion							
		0 - 300	0.02	145 x 90 x 44	30 x 12	0347 522	497.00
		0 - 600	0.02	189 x 118 x 44	30 x 12	0347 530	627.00
		0 - 1000	0.02	228 x 124 x 44	30 x 12	0347 534	865.00

0345 Replacement scribers for 0345 / 0347



Model

- Carbide tipped
- Packing: individually packed

☒	☒	Length mm	Material	Order no.	List price EUR
		75	Carbide-tipped	0345 910	124.00
		150	Carbide-tipped	0345 912	138.00



0345 / 0347 DIGI-MET® Height and scribing gauges



Model

- Measuring beam is made from stainless steel
- LCD-display 11 mm
- Setting screw
- Fine adjustment
- Accurate fine adjustment on gear rack and setting wheel with pinion
- Steel base with dirt grooves
- Scribing possible from base plate level
- Factory standard

Functions



- ON / OFF
- Set to zero at any point
- mm / inch switching
- PRESET-Function (setting a numerical value)
- Hold
- ABS (display can be set to zero without losing the Preset value)
- Reversal of counting direction
- Factor input
- Data output Proximity USB + RS232

Delivery

- With interchangeable scribing jaws, carbide tipped, 75 mm



② Fine adjustment on gear rack

☒ ☒	Measuring range		Reading		Base dimensions mm	Rail cross-section mm	Order no.	List price EUR
	mm	inch	mm	inch				
With fine adjustment								
	0 - 300	0 - 12	0.01	.0005	145 x 90 x 44	30 x 12	0345 722	562.00
	0 - 600	0 - 24	0.01	.0005	189 x 118 x 44	30 x 12	0345 730	702.00
	0 - 1000	0 - 39	0.01	.0005	228 x 124 x 44	30 x 12	0345 734	973.00
With pinion								
	0 - 300	0 - 12	0.01	.0005	145 x 90 x 44	30 x 12	0347 722	692.00
	0 - 600	0 - 24	0.01	.0005	189 x 118 x 44	30 x 12	0347 730	865.00
	0 - 1000	0 - 39	0.01	.0005	228 x 124 x 44	30 x 12	0347 734	1190.00

Accessories

Accessories	Order no.	List price EUR
Battery, 3V-Lithium, CR 2032	0220 704	3.90
Data cable Proximity to USB	1998 760	147.00

0345 Replacement scribers for 0345 / 0347



Model

- Carbide tipped
- Packing: individually packed

☒ ☒	Length mm	Material	Order no.	List price EUR
	75	Carbide-tipped	0345 910	124.00
	150	Carbide-tipped	0345 912	138.00



0349 DIGI-MET® Height gauges with sliding scriber



0349 722*

Model

- Measuring beam is made from stainless steel
- LCD-display 11 mm
- Fine adjustment
- Setting screw
- Steel base with dirt grooves
- Scribing possible from base plate level

Functions

- ON / OFF
- Set to zero at any point
- mm / inch switching
- PRESET-Function (setting a numerical value)
- Hold
- ABS (display can be set to zero without losing the Preset value)
- Reversal of counting direction
- Factor input
- Data output Proximity USB + RS232

Delivery

- With **straight** scriber

✕	📏	Measuring range		Reading		Base dimensions	Beam	Order no.	List price EUR
		mm	inch	mm	inch	mm	mm		
		0 - 300	0 - 12	0.01	.0005	145 x 90 x 44	30 x 12	0349 722	594.00
		0 - 600	0 - 24	0.01	.0005	189 x 118 x 44	30 x 12	0349 730	756.00
		0 - 1000	0 - 39	0.01	.0005	228 x 124 x 44	30 x 12	0349 734	1027.00

Accessories

Battery, 3V-Lithium, CR 2032
Data cable Proximity to USB

List price

EUR

0220 704
1998 760

3.90
147.00

*Figure does not show standard delivery content



0349 Replacement scribers for 0349



		Length mm	Material	Order no.	List price EUR
Cranked scriber, for marking operations from base					
		270	Special steel, hardened	0349 912	133.00
		270	Carbide-tipped	0349 916	169.00
Straight scriber					
		270	Special steel, hardened	0349 910	114.00
		270	Carbide-tipped	0349 914	148.00

Limited measuring range while using a cranked scriber

0331 Replacement scriber for height gauges not any longer included in our catalogue



Order no. Scriber	Order no. Height gauge	0330...	0331...	0336...	0338...	0340...	0342...	Material	Length mm	Shaft mm	List price EUR
0334 101		•		•		•	•	straight, carbide tipped	65	8 x 8	75.00
0334 102		•		•		•	•	straight, carbide tipped	75	-	124.00



HELIOS · PREISSER

SAMPLES **SQUARES**

SQUARE **WITH BASE**

SQUARE **WITHOUT BASE**



HIGH **QUALITY**

MADE IN **GERMANY**

Manufactured according to **DIN 875**

Highest precision:
Accuracy **grade 0**

Blade length up to **2 meters**
(Accuracy grade 2)

Made from **special** or **stainless** steel

More **highlights** from our range of **squares**



ACUTE ANGLE
SQUARES



MITRE SQUARES



BEVEL
PROTRACTORS

5. CHAPTER SQUARES, PROTRACTORS AND BEVEL PROTRACTORS

176	Squares with / without base
180	Steel squares
181	Squares with hard and slim blade
183	Knife edge squares
184	Inspection set
185	Centre squares / Flange squares
186	Mitre / Acute angle squares
188	Squares for specific measuring tasks and target groups
190	Wooden cases
191	Protractors
194	Universal bevel protractors

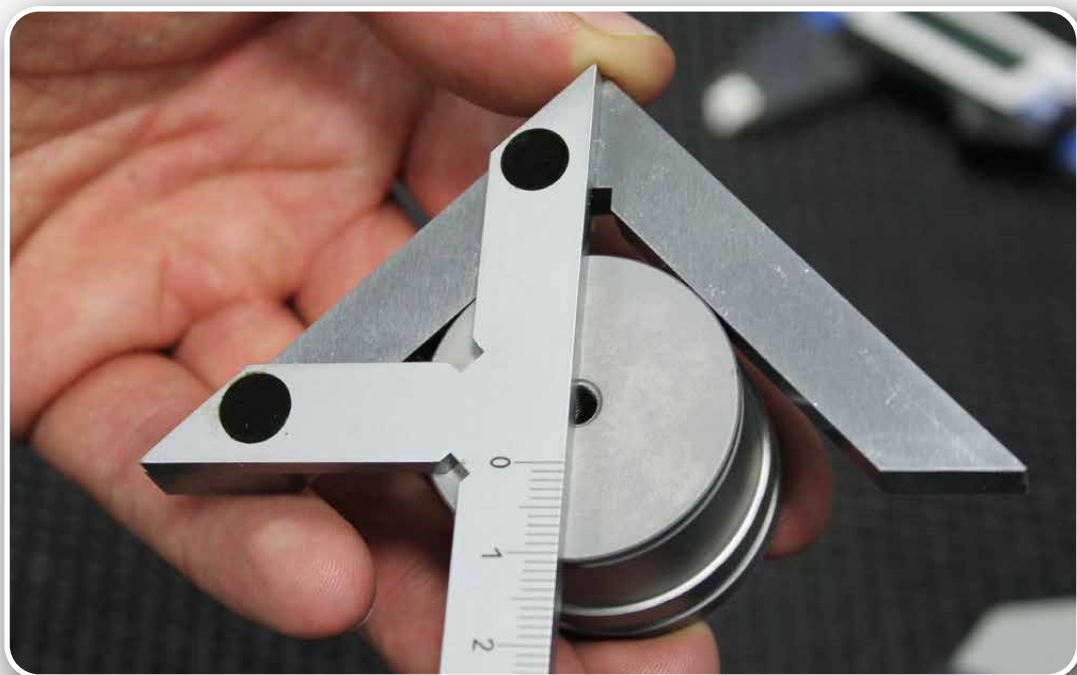



0368 Squares with base accuracy grade 0



		Jaw length mm	Cross-section mm	Order no.	List price EUR	DIN 875
Special steel						
		75 x 50	15 x 5	0368 102	25.20	
		100 x 70	20 x 5	0368 103	28.20	
		150 x 100	25 x 5	0368 104	37.80	
		200 x 130	30 x 6	0368 105	48.10	
		250 x 165	35 x 7	0368 106	64.00	
		300 x 200	40 x 8	0368 107	79.00	
		400 x 265	45 x 10	0368 108	173.00	
		500 x 330	50 x 10	0368 109	254.00	
		600 x 400	50 x 10	0368 110	359.00	
		750 x 500	60 x 12	0368 111	718.00	
	▪	1000 x 660	70 x 15	0368 112	1208.00	
Stainless steel						
		75 x 50	15 x 5	0368 202	48.00	
		100 x 70	20 x 5	0368 203	57.00	
		150 x 100	25 x 5	0368 204	78.00	
		200 x 130	30 x 6	0368 205	105.00	
		250 x 165	35 x 7	0368 206	147.00	
		300 x 200	40 x 8	0368 207	189.00	
		400 x 265	45 x 10	0368 208	293.00	
		500 x 330	50 x 10	0368 209	405.00	
		600 x 400	50 x 10	0368 210	602.00	
		750 x 500	60 x 12	0368 211	1034.00	
	▪	1000 x 660	70 x 15	0368 212	2193.00	

Model

- DIN 875
- Accuracy grade 0
- For exact angle testing (for example: tool making)

Delivery

- Cardboard box
- From blade length 1000 mm in a transportation box

0369 Squares without base accuracy grade 0



		Jaw length mm	Cross-section mm	Order no.	List price EUR	DIN 875
Special steel						
		75 x 50	15 x 5	0369 102	17.50	
		100 x 70	20 x 5	0369 103	18.90	
		150 x 100	25 x 5	0369 104	23.10	
		200 x 130	30 x 6	0369 105	32.00	
		250 x 165	35 x 7	0369 106	43.30	
		300 x 200	40 x 8	0369 107	60.00	
		400 x 265	45 x 10	0369 108	121.00	
		500 x 330	50 x 10	0369 109	158.00	
		600 x 400	50 x 10	0369 110	253.00	
		750 x 500	60 x 12	0369 111	470.00	
	▪	1000 x 660	70 x 15	0369 112	838.00	
Stainless steel						
		75 x 50	15 x 5	0369 202	32.40	
		100 x 70	20 x 5	0369 203	39.30	
		150 x 100	25 x 5	0369 204	48.00	
		200 x 130	30 x 6	0369 205	74.00	
		250 x 165	35 x 7	0369 206	97.00	
		300 x 200	40 x 8	0369 207	119.00	
		400 x 265	45 x 10	0369 208	202.00	
		500 x 330	50 x 10	0369 209	282.00	
		600 x 400	50 x 10	0369 210	473.00	
		750 x 500	60 x 12	0369 211	882.00	
	▪	1000 x 660	70 x 15	0369 212	1655.00	

Model

- DIN 875
- Accuracy grade 0
- For exact angle testing (for example: tool making)

Delivery

- Cardboard box
- From blade length 1000 mm in a transportation box



0385 Inspection squares with base accuracy grade 0, hardened



Model

- DIN 875
- Accuracy grade 0
- For exact angle testing (for example: tool making)

Delivery

- Cardboard box

**DIN
875**

	Jaw length mm	Cross-section mm	Order no.	List price EUR
Special steel				
	50 x 40	15 x 4	0385 102	25.30
	75 x 50	15 x 4	0385 103	27.00
	100 x 70	20 x 5	0385 104	32.30
	150 x 100	25 x 6	0385 105	48.20
	200 x 130	30 x 7	0385 106	67.00
	300 x 200	40 x 8	0385 108	117.00
Stainless steel				
	50 x 40	15 x 4	0385 202	35.10
	75 x 50	15 x 4	0385 203	39.00
	100 x 70	20 x 5	0385 204	48.20
	150 x 100	25 x 6	0385 205	64.00
	200 x 130	30 x 7	0385 206	82.00
	300 x 200	40 x 8	0385 208	121.00

0386 Inspection squares without base accuracy grade 0, hardened



Model

- DIN 875
- Accuracy grade 0
- For exact angle testing (for example: tool making)

Delivery

- Cardboard box

**DIN
875**

5

	Jaw length mm	Cross-section mm	Order no.	List price EUR
Special steel				
	50 x 40	15 x 4	0386 102	19.10
	75 x 50	15 x 4	0386 103	20.50
	100 x 70	20 x 5	0386 104	25.10
	150 x 100	25 x 6	0386 105	31.10
	200 x 130	30 x 7	0386 106	40.10
	300 x 200	40 x 8	0386 108	77.00
Stainless steel				
	50 x 40	15 x 4	0386 202	24.20
	75 x 50	15 x 4	0386 203	27.40
	100 x 70	20 x 5	0386 204	32.30
	150 x 100	25 x 6	0386 205	41.90
	200 x 130	30 x 7	0386 206	54.00
	300 x 200	40 x 8	0386 208	107.00



0370 Squares with base accuracy grade 1



**DIN
875**



Model

- DIN 875
- Accuracy grade 1
- For angle testing in production and factory

Delivery

- Cardboard box
- From blade length 1000 mm in a transportation box

		Jaw length mm	Cross-section mm	Order no.	List price EUR
Special steel					
		75 x 50	15 x 5	0370 102	15.60
		100 x 70	20 x 5	0370 103	17.50
		150 x 100	25 x 5	0370 104	23.50
		200 x 130	30 x 6	0370 105	29.90
		250 x 165	35 x 7	0370 106	40.00
		300 x 200	40 x 8	0370 107	49.80
		400 x 265	45 x 10	0370 108	99.00
		500 x 330	50 x 10	0370 109	145.00
		600 x 400	50 x 10	0370 110	205.00
		750 x 500	60 x 12	0370 111	410.00
	▪	1000 x 660	70 x 15	0370 112	690.00
Stainless steel					
		75 x 50	15 x 5	0370 202	17.20
		100 x 70	20 x 5	0370 203	19.20
		150 x 100	25 x 5	0370 204	29.00
		200 x 130	30 x 6	0370 205	38.00
		250 x 165	35 x 7	0370 206	52.00
		300 x 200	40 x 8	0370 207	69.00
		400 x 265	45 x 10	0370 208	175.00
		500 x 330	50 x 10	0370 209	225.00
		600 x 400	50 x 10	0370 210	350.00
		750 x 500	60 x 12	0370 211	542.00
	▪	1000 x 660	70 x 15	0370 212	876.00

0371 Squares without base accuracy grade 1



**DIN
875**



Model

- DIN 875
- Accuracy grade 1
- For angle testing in production and factory

Delivery

- Cardboard box
- From blade length 1000 mm in a transportation box

		Jaw length mm	Cross-section mm	Order no.	List price EUR
Special steel					
		75 x 50	15 x 5	0371 102	11.10
		100 x 70	20 x 5	0371 103	12.30
		150 x 100	25 x 5	0371 104	15.00
		200 x 130	30 x 6	0371 105	19.40
		250 x 165	35 x 7	0371 106	27.00
		300 x 200	40 x 8	0371 107	34.50
		400 x 265	45 x 10	0371 108	82.00
		500 x 330	50 x 10	0371 109	107.00
		600 x 400	50 x 10	0371 110	149.00
		750 x 500	60 x 12	0371 111	280.00
	▪	1000 x 660	70 x 15	0371 112	480.00
Stainless steel					
		75 x 50	15 x 5	0371 202	12.20
		100 x 70	20 x 5	0371 203	13.50
		150 x 100	25 x 5	0371 204	16.50
		200 x 130	30 x 6	0371 205	24.70
		250 x 165	35 x 7	0371 206	33.50
		300 x 200	40 x 8	0371 207	42.00
		400 x 265	45 x 10	0371 208	138.00
		500 x 330	50 x 10	0371 209	175.00
		600 x 400	50 x 10	0371 210	269.00
		750 x 500	60 x 12	0371 211	493.00
	▪	1000 x 660	70 x 15	0371 212	795.00



0372 Squares with base accuracy grade 2



Model

- Special steel
- DIN 875
- Accuracy grade 2
- For angle testing in production and factory

Delivery

- Cardboard box
- From blade length 1500 mm in a transportation box

**DIN
875**

▶	☒	Jaw length mm	Cross-section mm	Order no.	List price EUR
		75 x 50	15 x 5	0372 102	12.50
		100 x 70	20 x 5	0372 103	14.00
		150 x 100	25 x 5	0372 104	18.80
		200 x 130	30 x 6	0372 105	23.90
		250 x 165	35 x 7	0372 106	32.00
		300 x 175	35 x 7	0372 107	39.80
		400 x 200	35 x 7	0372 108	59.00
		500 x 250	40 x 8	0372 109	72.00
		600 x 300	40 x 8	0372 110	95.00
		750 x 375	45 x 10	0372 111	120.00
		1000 x 500	50 x 10	0372 112	175.00
	▪	1500 x 750	60 x 12	0372 113	769.00
	▪	2000 x 1000	60 x 12	0372 114	950.00

0373 Squares without base accuracy grade 2



Model

- Special steel
- DIN 875
- Accuracy grade 2
- For angle testing in production and factory

Delivery

- Cardboard box
- From blade length 1500 mm in a transportation box

**DIN
875**

5

▶	☒	Jaw length mm	Cross-section mm	Order no.	List price EUR
		75 x 50	15 x 5	0373 102	8.90
		100 x 70	20 x 5	0373 103	9.80
		150 x 100	25 x 5	0373 104	12.00
		200 x 130	30 x 6	0373 105	15.50
		250 x 165	35 x 7	0373 106	19.90
		300 x 175	35 x 7	0373 107	26.80
		400 x 200	35 x 7	0373 108	42.50
		500 x 250	40 x 8	0373 109	59.00
		600 x 300	40 x 8	0373 110	76.00
		750 x 375	45 x 10	0373 111	94.00
		1000 x 500	50 x 10	0373 112	145.00
	▪	1500 x 750	60 x 12	0373 113	699.00
	▪	2000 x 1000	60 x 12	0373 114	840.00



0374 Steel squares with base

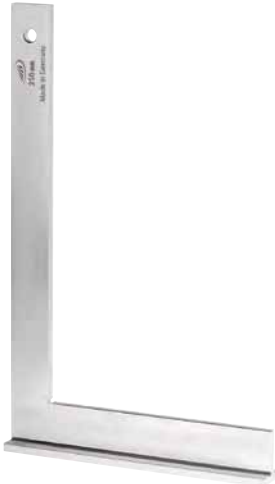

Model

- Special steel, zinc coated
- Factory standard
- Simple design for angle test in steel and metal construction

Delivery

- Cardboard box
- From blade length 1500 mm in a transportation box

✂	⚙	Jaw length mm	Cross-section mm	Order no.	List price EUR
		100 x 70	20 x 5	0374 404	10.50
		150 x 100	20 x 5	0374 408	11.80
		200 x 130	20 x 5	0374 410	14.20
		250 x 160	25 x 5	0374 412	17.20
		300 x 180	25 x 5	0374 414	21.00
		400 x 230	30 x 5	0374 416	26.50
		500 x 280	30 x 5	0374 418	35.20
		600 x 330	30 x 5	0374 420	47.20
		750 x 375	30 x 5	0374 424	56.00
		1000 x 500	30 x 5	0374 428	85.00
	▪	1500 x 750	40 x 5	0374 430*	199.00
	▪	2000 x 1000	40 x 5	0374 432*	292.00

*polished

0375 Steel squares without base



Model

- Special steel, zinc coated
- Factory standard
- Simple design for angle test in steel and metal construction

Delivery

- Cardboard box
- From blade length 1500 mm in a transportation box

✂	⚙	Jaw length mm	Cross-section mm	Order no.	List price EUR
		100 x 70	20 x 5	0375 404	7.70
		150 x 100	20 x 5	0375 408	8.10
		200 x 130	20 x 5	0375 410	8.60
		250 x 160	25 x 5	0375 412	10.50
		300 x 180	25 x 5	0375 414	11.50
		400 x 230	30 x 5	0375 416	15.80
		500 x 280	30 x 5	0375 418	17.50
		600 x 330	30 x 5	0375 420	21.50
		750 x 375	30 x 5	0375 424	25.50
		1000 x 500	30 x 5	0375 428	33.00
	▪	1500 x 750	40 x 5	0375 430*	96.00
	▪	2000 x 1000	40 x 5	0375 432*	145.00

*polished



0376 Squares with hard and slim blade, accuracy grade 1



Model

Delivery

**DIN
875**

- Special steel
- DIN 875
- Accuracy grade 1
- For angle testing in production and factory

- Cardboard box



✂	☒	Jaw length mm	Cross section with narrow beam mm	Cross section with wide beam mm	Order no.	List price EUR
		75 x 50	14 x 3	14 x 10	0376 102	12.30
		100 x 70	16 x 3	16 x 10	0376 103	13.10
		150 x 100	22 x 3	20 x 12	0376 104	16.50
		200 x 130	24 x 3	24 x 14	0376 105	27.10

0376 Squares with hard and slim blade, accuracy grade 2



Model

Delivery

**DIN
875**

- Special steel
- DIN 875
- Accuracy grade 2
- For angle testing in production and factory

- Cardboard box



✂	☒	Jaw length mm	Cross section with narrow beam mm	Cross section with wide beam mm	Order no.	List price EUR
		75 x 50	14 x 2	14 x 10	0376 112	11.50
		100 x 70	18 x 2	16 x 10	0376 113	12.20
		150 x 100	22 x 3	20 x 12	0376 114	14.80
		200 x 130	24 x 3	24 x 14	0376 115	20.70
		250 x 160	28 x 3	28 x 16	0376 116	25.60
		300 x 175	30 x 3	32 x 18	0376 117	30.50



0390 Squares with hard and slim blade, hardened, accuracy grade 0



Model

- DIN 875
- Accuracy grade 0
- For exact angle testing (for example: tool making)

Delivery

- Cardboard box

DIN
875



▶	☒	Jaw length mm	Cross section with narrow beam mm	Cross section with wide beam mm	Order no.	List price EUR
Special steel						
		50 x 40	16 x 2	14 x 10	0390 102	36.20
		75 x 50	18 x 2	14 x 10	0390 103	36.20
		100 x 70	18 x 2	16 x 10	0390 104	41.90
		150 x 100	22 x 3	20 x 12	0390 105	53.00
		200 x 130	26 x 3	24 x 14	0390 106	72.00
		300 x 200	32 x 3	30 x 18	0390 108	121.00
Stainless steel						
		50 x 40	16 x 2	14 x 10	0390 202	47.90
		75 x 50	18 x 2	14 x 10	0390 203	54.00
		100 x 70	18 x 2	16 x 10	0390 204	69.00
		150 x 100	22 x 3	20 x 12	0390 205	89.00
		200 x 130	26 x 3	24 x 14	0390 206	111.00
		300 x 200	32 x 3	30 x 18	0390 208	171.00

0391 Knife edge squares with hard and slim blade, hardened, accuracy grade 00



Model

- With knife edge
- DIN 875
- Accuracy grade 00
- For exact flatness testing (for example: in production)

Delivery

- Cardboard box

DIN
875



▶	☒	Jaw length mm	Cross section with narrow beam mm	Cross section with wide beam mm	Order no.	List price EUR
Special steel, non-glare knife edge						
		50 x 40	16 x 2	14 x 10	0391 102	56.00
		75 x 50	18 x 2	14 x 10	0391 103	56.00
		100 x 70	18 x 2	16 x 10	0391 104	73.00
		150 x 100	22 x 3	20 x 12	0391 105	92.00
		200 x 130	26 x 3	24 x 14	0391 106	124.00
		300 x 200	32 x 3	30 x 18	0391 108	181.00
Stainless steel						
		50 x 40	16 x 2	14 x 10	0391 202	67.00
		75 x 50	18 x 2	14 x 10	0391 203	75.00
		100 x 70	18 x 2	16 x 10	0391 204	85.00
		150 x 100	22 x 3	20 x 12	0391 205	109.00
		200 x 130	26 x 3	24 x 14	0391 206	140.00
		300 x 200	32 x 3	30 x 18	0391 208	227.00



0388 Knife edge squares, hardened, accuracy grade 00



Model

- DIN 875
- Accuracy grade 00
- For exact angle and flatness testing (for example: tool making)

Delivery

- Cardboard box

**DIN
875**

	Jaw length mm	Cross-section mm	Order no.	List price EUR
Special steel, non-glare knife edge				
	50 x 40	14 x 4	0388 102	20.20
	75 x 50	15 x 4	0388 103	24.00
	100 x 70	20 x 5	0388 104	28.70
	150 x 100	25 x 6	0388 105	38.60
	200 x 130	30 x 7	0388 106	54.00
	300 x 200	40 x 8	0388 108	94.00
Stainless steel				
	50 x 40	14 x 4	0388 202	24.00
	75 x 50	15 x 4	0388 203	28.20
	100 x 70	20 x 5	0388 204	34.00
	150 x 100	25 x 6	0388 205	43.90
	200 x 130	30 x 7	0388 206	65.00
	300 x 200	40 x 8	0388 208	142.00
	500 x 330	40 x 10	0388 210	676.00

0394 Knife edge squares



0394 101



0394 110

Model

- **0394101**
- Reading parts are satin chrome finished
- Sliding knife 7 x 7 x 60 mm
- Angle $\pm 5^\circ$
- Handle 40 x 23 x 9 mm
- For testing on short edges and grooves through the sliding knife edge

Delivery

- **0394110**
- Wooden case
- Reading parts are satin chrome finished
- Sliding knife edge 7 x 7 x 60 mm
- Handle 40 x 23 x 9 mm
- For tests at short grooves through the sliding straight edge

	Dimensions mm	Cross-section mm	Order no.	List price EUR
	60 x 35 x 13	7 x 7 x 100	0394 101	212.00
	40 x 23 x 9	7 x 7 x 60	0394 110	85.00

Accessories	Order no.	List price EUR
Replacement rule for 0394	0394 104	38,30



0387 Knife edge squares



Model

- Stainless steel
- DIN 875
- Accuracy grade 00
- Angle 90°
- Knife edge on the inside

Delivery

- Cardboard box

**DIN
875**

✕	☒	Jaw length mm	Cross section with narrow beam mm	Cross section with wide beam mm	Order no.	List price EUR
		25 x 20	5 x 3.5	6 x 3.5	0387 200	17.90
		40 x 28	5 x 3.5	8 x 3.5	0387 201	17.90

0397 5 piece inspection set



Model

set consisting of:

- Knife edge square, stainless steel 75 x 50 mm
- Knife edge square, stainless steel 40 x 28 mm
- Knife edge square, stainless steel 25 x 20 mm
- Knife edge rule, special steel 100 mm
- Gauge block scribe 60 x 9 x 9 mm

Delivery

- Wooden case

✕	☒	Order no.	List price EUR
		0397 101	184.00



0380 Centre squares

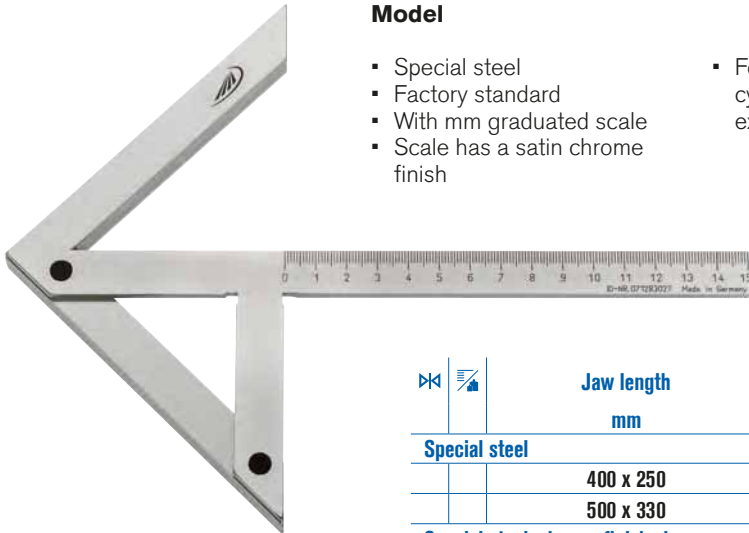

Model

- Special steel
- Factory standard
- With mm graduated scale
- Scale has a satin chrome finish
- For marking the centre of cylindrical workpieces, for example spindles, slices

Delivery

- Cardboard box

☒ ☒	Jaw length mm	For shaft dia. up to mm	Order no.	List price EUR
Special steel				
	400 x 250	380	0380 108	262.00
	500 x 330	530	0380 109	466.00
Special steel, chrome finished				
	100 x 70	90	0380 103	57.00
	150 x 130	190	0380 104	68.00
	200 x 150	220	0380 105	85.00
	250 x 160	230	0380 106	94.00
	300 x 180	280	0380 107	102.00

0396 Flange squares



Model

- Special steel, zinc coated
- Factory standard
- For accurately aligning flanges e.g. in plumbing and sanitary works in pipeline

Delivery

- Cardboard box
- From blade length 600 mm in transportation box

☒ ☒	Jaw length mm	Cross-section mm	Order no.	List price EUR
	300 x 300	30 x 5	0396 414	16.50
	400 x 400	30 x 5	0396 416	19.50
	500 x 500	30 x 5	0396 418	23.00
	▪ 600 x 600	30 x 5	0396 420	29.00
	▪ 800 x 800	30 x 5	0396 426	35.00



0395 Mitre squares 120°



Model

- Special steel
- Factory standard

Delivery

- Cardboard box

▶	▶	Jaw length mm	Cross-section mm	Order no.	List price EUR
Flat, without base					
		50 x 50	15 x 5	0395 132	8.60
		75 x 75	18 x 5	0395 133	11.00
		100 x 100	20 x 5	0395 134	13.30

0395 Mitre squares 135°



Model

- Special steel
- Factory standard

Delivery

- Cardboard box

▶	▶	Jaw length mm	Cross-section mm	Order no.	List price EUR
With base					
		120 x 80	20 x 5	0395 142	19.10
		150 x 100	20 x 5	0395 143	21.60
		200 x 130	25 x 5	0395 144	28.20
Flat, without base					
		50 x 50	15 x 5	0395 136	8.60
		75 x 75	18 x 5	0395 137	11.00
		100 x 100	20 x 5	0395 138	13.30
		120 x 80	20 x 5	0395 146	14.10
		150 x 100	20 x 5	0395 147	19.10
		200 x 130	25 x 5	0395 148	25.80



0395 Acute angle squares 60°



Model

- Special steel
- Factory standard

Delivery

- Cardboard box

		Jaw length mm	Cross-section mm	Order no.	List price EUR
With base					
		120 x 80	20 x 5	0395 122	26.50
		150 x 100	20 x 5	0395 123	30.30
		200 x 130	25 x 5	0395 124	40.60
Flat, without base					
		120 x 80	20 x 5	0395 126	19.00
		150 x 100	20 x 5	0395 127	21.20
		200 x 130	25 x 5	0395 128	29.80

0395 Acute angle squares 45°



Model

- Special steel
- Factory standard

Delivery

- Cardboard box

		Jaw length mm	Cross-section mm	Order no.	List price EUR
With base					
		120 x 80	20 x 5	0395 102	28.00
		150 x 100	20 x 5	0395 103	31.10
		200 x 130	25 x 5	0395 104	41.90
Flat, without base					
		120 x 80	20 x 5	0395 106	19.70
		150 x 100	20 x 5	0395 107	21.60
		200 x 130	25 x 5	0395 108	31.10



0396 Carpenters squares

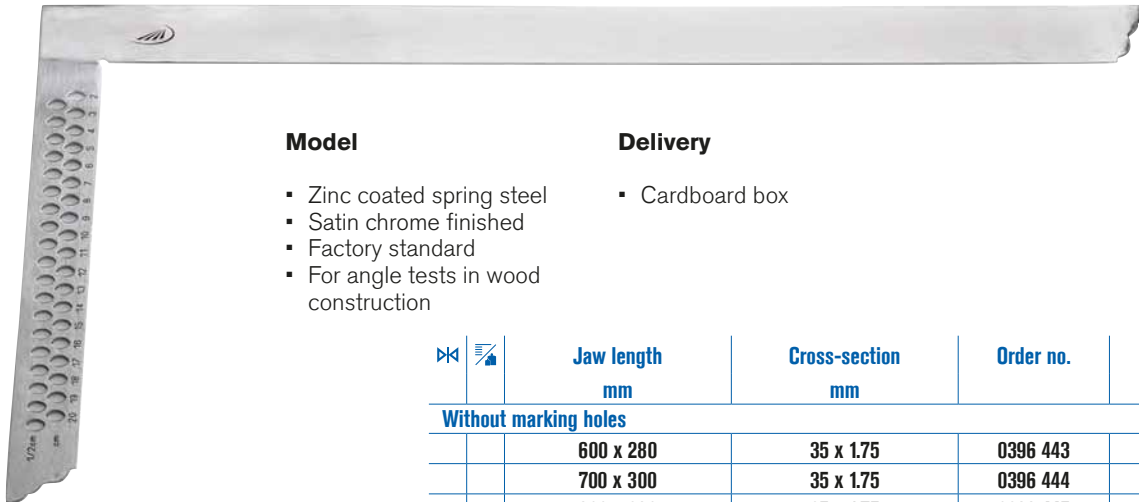

Model

- Zinc coated spring steel
- Satin chrome finished
- Factory standard
- For angle tests in wood construction

Delivery

- Cardboard box

Marked	Jaw length mm	Cross-section mm	Order no.	List price EUR
Without marking holes				
	600 x 280	35 x 1.75	0396 443	10.50
	700 x 300	35 x 1.75	0396 444	12.40
	800 x 320	35 x 1.75	0396 445	13.40
	1000 x 380	35 x 1.75	0396 446	17.30
With marking holes				
	600 x 280	35 x 1.75	0396 453	13.20
	700 x 300	35 x 1.75	0396 454	14.90
	800 x 320	35 x 1.75	0396 455	16.60
	1000 x 380	35 x 1.75	0396 456	20.30

0396 Alpha squares with marking holes



Model

- Stainless steel
- Long blade with mm graduation, short blade used as adjustable protractor and for marking and production of wood joints 0°-90°

Delivery

- Cardboard box

Marked	Jaw length mm	Cross-section mm	Order no.	List price EUR
	430 x 795	35	0396 290	96.00



0396 Joiner squares with mitre

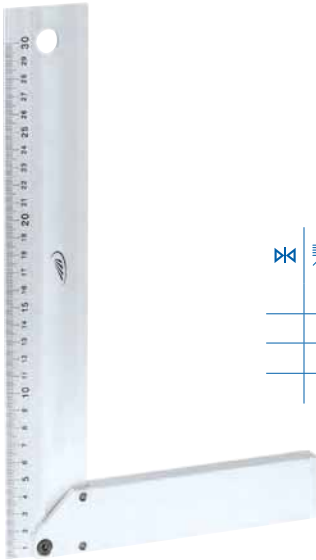



Model

- Aluminium
- mm graduation

Delivery

- Cardboard box

 	Jaw length mm	Cross section with narrow beam mm	Cross section with wide beam mm	Order no.	List price EUR
	250 x 148	40 x 14	50 x 5	0396 982	11.90
	300 x 164	40 x 14	50 x 5	0396 983	14.10
	400 x 195	40 x 14	50 x 5	0396 984	16.80

0396 Adjustable square





Model

- Special steel, zinc coated
- Satin chrome finished
- Screw hinge
- For transferring, marking and setting of individual angles

Delivery

- Cardboard box

 	Jaw length mm	Cross-section mm	Order no.	List price EUR
	200	20 x 8	0396 432	9.80
	250	25 x 8	0396 433	12.10
	300	25 x 8	0396 434	14.80
	400	25 x 8	0396 435	19.00
	500	25 x 8	0396 436	21.20



0003 Wooden cases for squares



	Jaw length mm	Internal dimensions L x W x H mm	Order no.	List price EUR
For squares with base				
	150 x 100	160 x 105 x 27	0003 284	6.80
	200 x 130	210 x 135 x 34	0003 286	9.00
	250 x 165	260 x 170 x 38	0003 288	19.30
	300 x 200	312 x 205 x 42	0003 290	19.30
	400 x 265	412 x 270 x 48	0003 292	36.80
	500 x 330	512 x 335 x 54	0003 294	41.50
For flat type squares				
	150 x 100	160 x 105 x 22	0003 283	6.10
	200 x 130	210 x 135 x 27	0003 285	7.70
	250 x 165	260 x 170 x 27	0003 287	8.50
	300 x 200	312 x 205 x 27	0003 289	11.60
	400 x 265	412 x 270 x 27	0003 291	33.30
	500 x 330	512 x 335 x 27	0003 293	37.10
For squares with and without base				
	50 x 40	55 x 45 x 22	0003 280	4.30
	75 x 50	80 x 55 x 22	0003 281	4.70
	100 x 70	105 x 75 x 22	0003 282	4.90



0411 Protractors



Model

- Locking screw
- High precision, laser graduated degree scale
- Factory standard
- 0 - 180°

Delivery

- Cardboard box

☒ ☒	Jaw length	Graduated arc dia.	Order no.	List price
	mm	mm		EUR
Special steel				
	120	80	0411 101	22.60
	150	120	0411 102	28.20
	200	150	0411 103	35.40
	300	200	0411 104	46.90
	500	300	0411 105	71.00
	600	300	0411 106	82.00
	800	300	0411 107	108.00
	600	400	0411 108	140.00
	800	400	0411 109	148.00
	1000	400	0411 110	154.00
Special steel, satin chrome finished graduated arc				
	120	80	0411 301	25.10
	150	120	0411 302	32.30
	200	150	0411 303	35.90
	300	200	0411 304	52.00
	500	300	0411 305	103.00
	600	300	0411 306	130.00
	800	300	0411 307	141.00
	600	400	0411 308	147.00
	800	400	0411 309	155.00
	1000	400	0411 310	191.00

0412 Protractors



Model

- Locking screw
- Stainless steel
- Factory standard
- 0 - 180°
- High precision, laser graduated degree scale

Delivery

- Cardboard box

☒ ☒	Jaw length	Graduated arc dia.	Order no.	List price
	mm	mm		EUR
	120	80	0412 201	35.40
	150	120	0412 202	38.30
	200	150	0412 203	39.40
	300	200	0412 204	55.00



0413 Protractors



0413 301

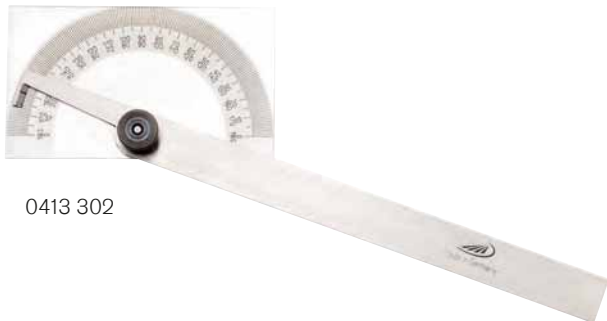

0413 302

Model

- Locking screw
- Special steel
- Factory standard
- 0 - 180°
- High precision, laser graduated degree scale
- Graduated in opposite directions
- Satin chrome finished

Delivery

- Cardboard box

	✂	📏	Dimensions	Jaw length	Order no.	List price
			mm	mm		EUR
			Ø 85	150	0413 301	23.90
			85 x 50	150	0413 302	24.90

0415 Bevel protractors



Model

- Locking screw
- Special steel, pointer arm is satin chrome finished
- Factory standard
- Adjustable stop bar 10° - 170°
- High precision, laser graduated degree scale

Delivery

- Cardboard box

	✂	📏	Jaw length	Graduated arc dia.	Order no.	List price
			mm	mm		EUR
			150	100	0415 301	65.00
			300	150	0415 302	101.00
			400	200	0415 303	137.00
			500	250	0415 304	188.00
			600	300	0415 305	213.00



0416 Bevel protractors with double stop rail



Model

- Locking screw
- Special steel, pointer arm is satin chrome finished
- Factory standard
- Adjustable stop bar
10° - 170°
- High precision, laser graduated degree scale
- Two-way adjustable stop bar

Delivery

- Cardboard box

✕	☰	Jaw length	Graduated arc dia.	Order no.	List price
		mm	mm		EUR
		150	100	0416 301	130.00
		300	150	0416 302	170.00
		400	200	0416 303	220.00
		500	250	0416 304	364.00
		600	300	0416 305	422.00



0425 DIGI-MET® Universal bevel protractors



Model

- Clamping unit
- Stainless steel
- Factory standard
- Reversible measuring range:
 - 1 x 360°
 - 2 x 180°
 - 4 x 90°
- Reversible indication
 - degree and minutes
 - decimal degree

Functions

- ON / OFF
- Set to zero at any point
- Data output Opto RS 232

Delivery

- Wooden case

✕	☒	Blade length mm	Reading mm	Order no.	List price EUR
		150	0.01° or 1'	0425 701	1318.00
		200	0.01° or 1'	0425 702	1331.00
		300	0.01° or 1'	0425 703	1342.00



0996701

0996705

Accessories

	Order no.	List price EUR
Battery, 3V-Lithium, CR 2032	0220 704	3.90
data cable opto to RS232	0996 701	77.00
data cable opto to USB	0996 705	147.00



0420 Universal level protractors



Model

- Locking screw
- Stainless steel
- Factory standard
- Vernier scale reading 5 minutes

Delivery

- Cardboard box

Measuring range in °	Blade length mm	Order no.	List price EUR
4 x 90 °	150	0420 201	56.00
4 x 90 °	200	0420 202	60.00
4 x 90 °	300	0420 203	65.00

Accessories

	Order no.	List price EUR
Replacement magnifying lense	0420 121	16.30
Replacement blade 150 mm	0420 206	18.40
Replacement blade 200 mm	0420 207	19.30
Replacement blade 300 mm	0420 208	19.50



0420121



0420122



0420124



0420206



SAMPLES GAUGES

PLUG GAUGES

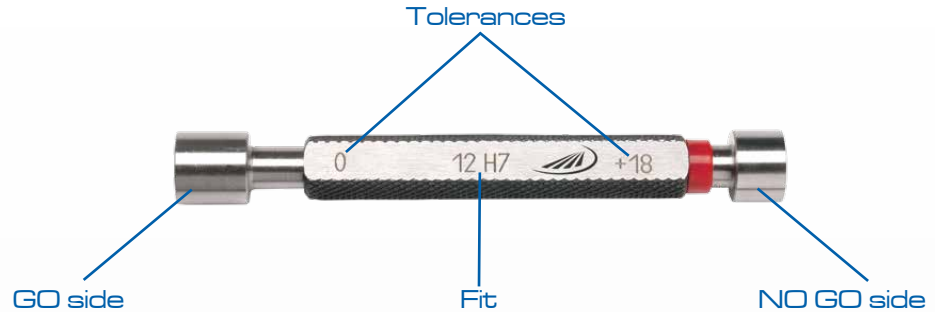

OUR SPECIAL OFFER:

PLUG GAUGES WITH REQUIRED FIT
OR INDIVIDUAL TOLERANCES
ACCORDING TO YOUR SPECIFICATIONS

BESTSELLER:

FEELER GAUGE TAPES IN
SINGLE BOXES



NOW AVAILABLE
FROM **STAINLESS STEEL**



AS SET IN OUR CONVENIENT
WALLHOLDER

Incl. holder for
feeler gauge tapes



6. CHAPTER GAUGES, RULES INSPECTION EQUIPMENT

198	Graduated rules
201	Steel scale tapes for circumference and diameter
202	Edges and rules
205	Knife edge rules
206	Inspection plates made from cast iron
207	Lapping and inspection plate
208	Prisms
214	Sets of parallel blocks
215	Levels
216	Combined lathe and thread cutting gauges
218	ISO indicators
220	Twist drill grinding and profile gauges
221	Grinding / Welding gauges
223	Radius / Chamfer gauge
223	Tapered hole gauges
225	Drill and steel wire hole gauges, radius gauges
226	Feeler gauges
228	Feeler gauge tapes
230	Precision reference sheets
233	Gauge blocks and accessories
240	Pin gauges
242	Snap gauges, setting rings
244	Plug gauges
246	Thread plug- and ring gauges



0460 Flexible steel rules

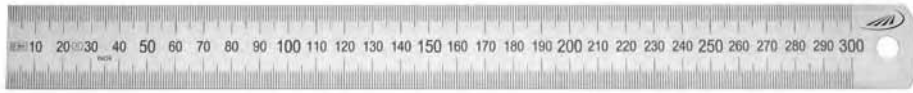

0460 204





0460 222



0460 242

Model

- Stainless spring band steel
- EC grade II
- Rules with special graduations or other scales are available upon request

		Length mm	Cross-section mm	Order no.	List price EUR
Scales: mm top and bottom					
		150	13 x 0.5	0460 201	1.10
		200	13 x 0.5	0460 202	1.10
		300	15 x 0.5	0460 204	1.60
		500	20 x 0.5	0460 205	4.30
		1000	20 x 0.5	0460 206	9.20
		300	30 x 1.0	0460 207	3.20
		500	30 x 1.0	0460 208	7.70
		1000	30 x 1.0	0460 209	16.00
		1500	30 x 1.0	0460 210	25.80
		2000	30 x 1.0	0460 211	31.10
		3000	30 x 1.0	0460 212	72.00
	▪	3000	30 x 2.0	0460 213	111.00
Scales: 1/2 mm top, mm bottom					
		150	13 x 0.5	0460 221	1.10
		200	13 x 0.5	0460 222	1.10
		250	15 x 0.5	0460 223	1.60
		300	15 x 0.5	0460 224	1.60
		500	20 x 0.5	0460 225	4.30
		1000	20 x 0.5	0460 226	9.20
		300	30 x 1.0	0460 227	3.20
		500	30 x 1.0	0460 228	7.70
		1000	30 x 1.0	0460 229	16.00
		1500	30 x 1.0	0460 230	25.80
		2000	30 x 1.0	0460 231	31.10
		3000	30 x 1.0	0460 232	72.00
	▪	3000	30 x 2.0	0460 233	111.00
Scales: 1/16", 1/32", 1/64" top; 1/2 mm, 1/1 mm bottom					
		150	13 x 0.5	0460 241	1.10
		200	13 x 0.5	0460 242	1.10
		250	15 x 0.5	0460 243	1.60
		300	15 x 0.5	0460 244	1.60
		500	20 x 0.5	0460 245	4.30
		1000	20 x 0.5	0460 246	9.20
		300	30 x 1.0	0460 247	3.20
		500	30 x 1.0	0460 248	7.70
		1000	30 x 1.0	0460 249	16.00
		1500	30 x 1.0	0460 250	25.80
		2000	30 x 1.0	0460 251	31.10
		3000	30 x 1.0	0460 252	72.00
	▪	3000	30 x 2.0	0460 253	111.00



0460 Flexible steel rules, satin chrome



0460 502



0460 522

Model

- Stainless spring band steel
- Scales satin chrome finished
- EC grade II

☒ ☒	☒ ☒	Length mm	Cross-section mm	Order no.	List price EUR
Scales: mm top and bottom					
		150	13 x 0.5	0460 501	2.70
		200	13 x 0.5	0460 502	4.30
		300	15 x 0.5	0460 504	4.90
		500	20 x 0.5	0460 505	10.70
		1000	20 x 0.5	0460 506	21.80
		300	30 x 1.0	0460 507	5.60
		500	30 x 1.0	0460 508	11.80
		1000	30 x 1.0	0460 509	24.60
	▪	1500	35 x 1.5	0460 510	72.00
	▪	2000	35 x 1.5	0460 511	113.00
Scales: 1/2 mm top, mm bottom					
		150	13 x 0.5	0460 521	2.70
		200	13 x 0.5	0460 522	4.30
		300	15 x 0.5	0460 524	4.90
		500	20 x 0.5	0460 525	10.70
		1000	20 x 0.5	0460 526	21.80
		300	30 x 1.0	0460 527	5.60
		500	30 x 1.0	0460 528	11.80
		1000	30 x 1.0	0460 529	24.60

0453 Aluminium straight edges, anodized



0453 422

Model

- Bevelled edge
- Non-glare mm graduation
- Factory standard

☒ ☒	☒ ☒	Length mm	Cross-section mm	Order no.	List price EUR
		300	50 x 5	0453 422	8.90
		600	50 x 5	0453 430	13.20
		1000	50 x 5	0453 434	19.50



0451 Graduated straight rules acc. to DIN 866, type A



DIN
866-A

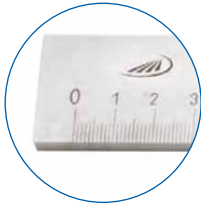

Model

- Both-sided 10 mm protective ends
- mm graduated scale

Delivery

- Cardboard box
- From 2000 mm in transportation box

	Length mm	Cross-section mm	Order no.	List price EUR
Special steel				
	500	30 x 6	0451 101	25.80
	1000	40 x 8	0451 102	59.00
▪	1500	40 x 8	0451 103	106.00
▪	2000	50 x 10	0451 104	147.00
▪	3000	50 x 10	0451 105	304.00
▪	4000	60 x 12	0451 106	552.00
Stainless steel				
	500	30 x 6	0451 201	45.70
	1000	40 x 8	0451 202	105.00
▪	1500	40 x 8	0451 203	156.00
▪	2000	50 x 10	0451 204	274.00
▪	3000	50 x 10	0451 205	552.00
▪	4000	60 x 12	0451 206	998.00

0452 Graduated straight rules acc. to DIN 866, type B



DIN
866-B

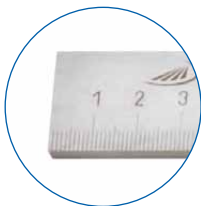

Model

- Graduated scale begins directly on the end of rule, the other end has a 10 mm protective end
- mm graduated scale

Delivery

- Cardboard box
- From 2000 mm in transportation box

	Length mm	Cross-section mm	Order no.	List price EUR
Special steel				
	500	25 x 5	0452 101	20.30
	1000	30 x 6	0452 103	40.10
▪	1500	30 x 6	0452 104	58.00
▪	2000	40 x 8	0452 105	95.00
▪	2500	40 x 8	0452 106	150.00
▪	3000	40 x 8	0452 107	166.00
▪	4000	50 x 10	0452 108	317.00
▪	5000	60 x 12	0452 109	570.00
Stainless steel				
	500	25 x 5	0452 201	27.10
	1000	30 x 6	0452 203	59.00
▪	1500	30 x 6	0452 204	101.00
▪	2000	40 x 8	0452 205	160.00
▪	2500	40 x 8	0452 206	306.00
▪	3000	40 x 8	0452 207	318.00
▪	4000	50 x 10	0452 208	572.00
▪	5000	60 x 12	0452 209	1090.00





0458 Steel scale tapes for circumference and diameter



0458 104



0458 102

Model

- Factory standard
- Vernier 0.1 mm
- Main scale graduation 1 mm

Delivery

- Cardboard box

For circumference mm	For dia. mm	Order no.	List price EUR
Spring band steel			
60 - 950	20 - 300	0458 102	38.30
940 - 2200	300 - 700	0458 103	45.70
2190 - 3460	700 - 1100	0458 104	59.00
3450 - 4720	1100 - 1500	0458 105	71.00
4710 - 5980	1500 - 1900	0458 106	85.00
5960 - 7230	1900 - 2300	0458 107	98.00
7220 - 8500	2300 - 2700	0458 108	242.00
8480 - 9760	2700 - 3100	0458 109	259.00
9730 - 11010	3100 - 3500	0458 110	333.00
11000 - 12260	3500 - 3900	0458 111	511.00
12250 - 13500	3900 - 4300	0458 112	521.00
13500 - 14760	4300 - 4700	0458 113	531.00
Stainless spring band steel			
60 - 950	20 - 300	0458 202	68.00
940 - 2200	300 - 700	0458 203	86.00
2190 - 3460	700 - 1100	0458 204	105.00
3450 - 4720	1100 - 1500	0458 205	139.00
4710 - 5980	1500 - 1900	0458 206	168.00



0454 Straight edges, with bevelled edge



Model

- Special steel
- Zinc coated
- Factory standard

Delivery

- Cardboard box
- From 2000 mm in transportation box

☒ ☒	☒	Length mm	Cross-section mm	Order no.	List price EUR
		400	40 x 5	0454 424	9.40
		500	40 x 5	0454 428	11.70
	▪	1000	40 x 5	0454 434	23.20
	▪	1500	40 x 5	0454 438	42.20
	▪	2000	40 x 5	0454 440	64.00
	▪	3000	50 x 8	0454 444	169.00

0455 Straight edges with bevelled edge, mm graduation



Model

- Special steel
- Zinc coated
- Factory standard
- Graduated scale begins directly on the end of rule, the other end has a 10 mm protective end

Delivery

- Cardboard box
- From 2000 mm in transportation box

☒ ☒	☒	Length mm	Cross-section mm	Order no.	List price EUR
		400	40 x 5	0455 424	17.30
		500	40 x 5	0455 428	21.60
	▪	1000	40 x 5	0455 434	41.00
	▪	1500	40 x 5	0455 438	73.00
	▪	2000	40 x 5	0455 440	107.00
	▪	3000	50 x 8	0455 444	226.00





0464 Steel rules made of special steel, accuracy grade 0



rectangular cross section



I shaped cross section, 2 hand slots

Model

- Special steel
- Measuring surfaces are finely grinded
- Flatness of measuring surfaces according to DIN 874

Delivery

- Cardboard box
- From 2000 mm in transportation box

		Length mm	Cross-section mm	Order no.	List price EUR
Special steel, rectangular cross section					
		500	50 x 10	0464 101	66.00
		750	50 x 10	0464 102	94.00
		1000	60 x 12	0464 103	147.00
	▪	1500	70 x 15	0464 104	248.00
Special steel, I shaped cross section, 2 hand slots					
	▪	2000	80 x 15	0464 105	445.00
	▪	2500	100 x 16	0464 106	756.00
	▪	3000	120 x 20	0464 107	1161.00
	▪	4000	140 x 20	0464 108	1995.00

0465 Steel rules made of special steel, accuracy grade 1



		Length mm	Cross-section mm	Order no.	List price EUR
Special steel, rectangular cross section					
		500	40 x 8	0465 101	32.30
		750	50 x 10	0465 102	53.00
		1000	50 x 10	0465 103	72.00
	▪	1500	60 x 12	0465 104	132.00
Special steel, I shaped cross section, 2 hand slots					
	▪	2000	70 x 15	0465 105	268.00
	▪	2500	80 x 15	0465 106	502.00
	▪	3000	100 x 16	0465 107	862.00
	▪	4000	120 x 20	0465 108	1393.00

0466 Steel rules made of special steel, accuracy grade 2



		Length mm	Cross-section mm	Order no.	List price EUR
Special steel, rectangular cross section					
		500	30 x 6	0466 101	22.20
		750	40 x 8	0466 102	39.00
		1000	40 x 8	0466 103	44.40
	▪	1500	50 x 10	0466 104	85.00
	▪	2000	60 x 12	0466 105	116.00
	▪	2500	70 x 15	0466 106	256.00
	▪	3000	80 x 15	0466 107	400.00
Special steel, I shaped cross section, 2 hand slots					
	▪	4000	100 x 16	0466 108	951.00



0464 Steel rules made of stainless steel, accuracy grade 0



rectangular cross section



I shaped cross section, 2 hand slots



Model

- Special steel
- Measuring surfaces are finely grinded
- Flatness of measuring surfaces according to DIN 874

Delivery

- Cardboard box
- From 2000 mm in transportation box

		Length mm	Cross-section mm	Order no.	List price EUR
Stainless steel, rectangular cross section					
		500	50 x 10	0464 201	104.00
		750	50 x 10	0464 202	142.00
		1000	60 x 12	0464 203	268.00
	▪	1500	70 x 15	0464 204	445.00
Stainless steel, I shaped cross section, 2 hand slots					
	▪	2000	80 x 15	0464 205	823.00
	▪	2500	100 x 16	0464 206	1433.00
	▪	3000	120 x 18	0464 207	2534.00
	▪	4000	140 x 20	0464 208	4520.00

0465 Steel rules made of stainless steel, accuracy grade 1



		Length mm	Cross-section mm	Order no.	List price EUR
Stainless steel, rectangular cross section					
		500	40 x 8	0465 201	59.00
		750	50 x 10	0465 202	91.00
		1000	50 x 10	0465 203	164.00
	▪	1500	60 x 12	0465 204	256.00
Stainless steel, I shaped cross section, 2 hand slots					
	▪	2000	70 x 15	0465 205	604.00
	▪	2500	80 x 15	0465 206	920.00
	▪	3000	100 x 16	0465 207	1772.00
	▪	4000	120 x 18	0465 208	2610.00

0466 Steel rules made of stainless steel, accuracy grade 2



		Length mm	Cross-section mm	Order no.	List price EUR
Stainless steel, rectangular cross section					
		500	30 x 6	0466 201	38.30
		750	40 x 8	0466 202	67.00
		1000	40 x 8	0466 203	98.00
	▪	1500	50 x 10	0466 204	204.00
	▪	2000	60 x 12	0466 205	344.00
	▪	2500	70 x 15	0466 206	572.00
	▪	3000	80 x 15	0466 207	817.00
Stainless steel, I shaped cross section. 2 hand slots					
	▪	4000	100 x 16	0466 208	1521.00



0512 Knife edge rules



0512 101

**DIN
874**

Model

- DIN 874 Sheet 2, accuracy grade 00
- Thermally insulated
- Pointed tip at one end
- Special steel: glare free and burnished knife edge
- Stainless steel: non glare knife edge up to 500 mm

Delivery

- Up to 500 mm in imitation leather case. From 500 mm individually packed

Length mm	Cross-section mm	Order no.	List price EUR
Special steel, hardened and grinded			
75	25 x 5	0512 101	10.50
100	25 x 5	0512 102	11.80
125	25 x 5	0512 103	13.30
150	25 x 5	0512 104	15.10
200	29 x 7	0512 105	19.70
300	29 x 7	0512 106	37.10
400	33 x 10	0512 107	66.00
500	33 x 10	0512 108	104.00
Stainless steel, hardened and grinded			
75	25 x 5	0512 201	13.70
100	25 x 5	0512 202	16.00
125	25 x 5	0512 203	16.70
150	25 x 5	0512 204	18.70
200	29 x 7	0512 205	21.60
300	29 x 7	0512 206	46.90
400	33 x 10	0512 207	85.00
500	33 x 10	0512 208	116.00
600	45 x 10	0512 209	224.00
750	60 x 12	0512 210	454.00
1000	60 x 12	0512 211	595.00

0512 Wooden cases for knife edge rules



Length mm	Order no.	List price EUR
75	0512 601	5.40
100	0512 602	5.40
125	0512 603	5.40
150	0512 604	6.50
200	0512 605	7.60
300	0512 606	8.60
400	0512 607	10.80
500	0512 608	16.30
600	0512 609	16.30
750	0512 610	32.50
1000	0512 611	37.90



0478 Inspection plates



DIN
876-2

Model

- Flatness in accordance to DIN 876-2
- Special cast iron
- Rigid construction

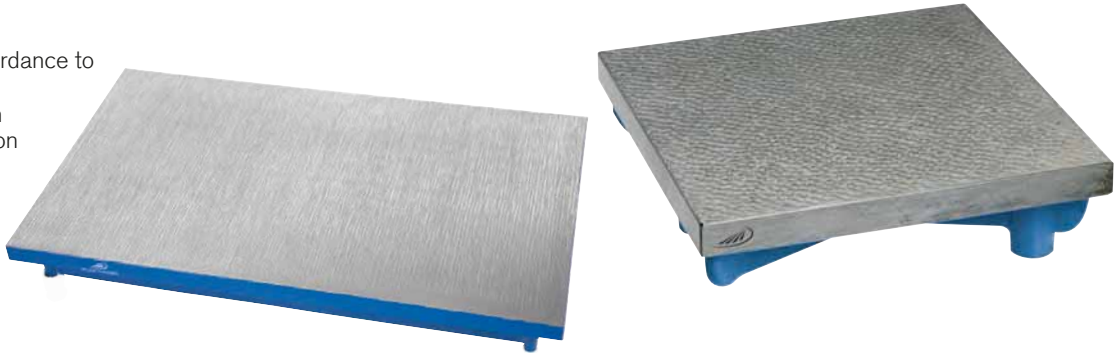

		Base dimensions mm	Accuracy grade	Order no.	List price EUR
Scraped					
		200 x 200	0	0478 012	172.00
		300 x 300	0	0478 015	301.00
	▪	400 x 300	0	0478 016	379.00
	▪	400 x 400	0	0478 017	491.00
Microground					
		200 x 200	1	0478 112	135.00
		300 x 300	1	0478 115	223.00
	▪	400 x 300	1	0478 116	301.00
	▪	400 x 400	1	0478 117	379.00
	▪	500 x 400	1	0478 118	423.00
	▪	500 x 500	1	0478 119	546.00
	▪	600 x 500	1	0478 121	602.00
	▪	800 x 500	1	0478 124	1002.00
	▪	1000 x 600	1	0478 127	1782.00
Grinded					
		200 x 200	3	0478 312	101.00
		300 x 300	3	0478 315	162.00
	▪	400 x 300	3	0478 316	195.00
	▪	400 x 400	3	0478 317	233.00
	▪	500 x 400	3	0478 318	301.00
	▪	500 x 500	3	0478 319	446.00
	▪	600 x 500	3	0478 321	491.00
	▪	800 x 500	3	0478 324	701.00
	▪	1000 x 600	3	0478 327	1114.00



0478 Base stand for inspection plates



		For plate size mm	Order no.	List price EUR
		400 x 400	0478 907	324.00
		500 x 400	0478 908	324.00
		500 x 500	0478 909	347.00
	▪	600 x 500	0478 911	365.00
	▪	800 x 500	0478 914	412.00
	▪	1000 x 600	0478 917	495.00

0482 Lapping and inspection plate

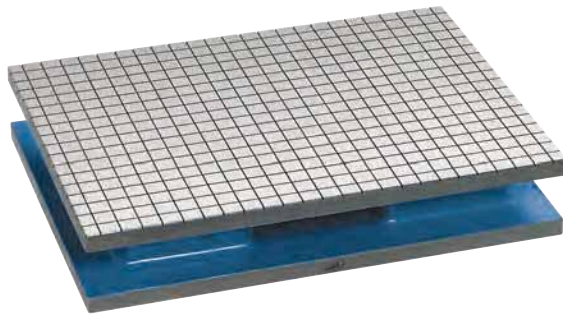

Model

- High grade cast iron
- Finely ground
- One side for lapping with rectangular grooves
- One side as inspection plate flat straight trough

Delivery

- Wooden case

		Base dimensions mm	Order no.	List price EUR
	▪	360 x 260 x 65	0482 101	488.00



0504 V-blocks (pair)



Model

- Special cast iron
- 90° grooves
- Machined in pairs

Delivery

- In pairs
- Cardboard box

⌘	⌘	Base dimensions mm	For shaft dia. mm	Accuracy grade	Order no.	List price EUR
Parallelism tolerance < 0.008 mm, V-grooves and base finely grinded						
		100 x 40 x 30	6 - 40	0	0504 012	93.00
		150 x 50 x 40	8 - 50	0	0504 013	145.00
		200 x 70 x 50	8 - 70	0	0504 014	223.00
Parallelism tolerance < 0.016 mm, V-grooves and base grinded						
		100 x 40 x 30	6 - 40	1	0504 112	66.00
		150 x 50 x 40	8 - 50	1	0504 113	88.00
		200 x 70 x 50	8 - 70	1	0504 114	145.00
Parallelism tolerance < 0.064 mm, V-grooves and base milled						
		100 x 40 x 30	6 - 40	3	0504 312	45.50
		150 x 50 x 40	8 - 50	3	0504 313	67.00
		200 x 70 x 50	8 - 70	3	0504 314	110.00

0520 V-blocks (pair)



Model

- Special steel, hardened
- Parallelism from prism to base 0.004 mm
- 90° grooves
- Machined in pairs

Delivery

- In pairs
- Cardboard box

⌘	⌘	Base dimensions L x W x H mm	For shaft dia. mm	Order no.	List price EUR
		75 x 35 x 30	5 - 40	0520 101	133.00
		100 x 47 x 40	5 - 55	0520 102	175.00
		150 x 55 x 45	5 - 60	0520 103	232.00
		200 x 65 x 55	5 - 75	0520 104	324.00
		250 x 85 x 70	5 - 100	0520 105	443.00



0508 Pair of X type V-blocks (parallel)



Model

- Factory standard
- Special cast iron
- 4 x 90° grooves, different sizes
- Machined in pairs

Delivery

- In pairs
- Cardboard box

▢	▣	Base dimensions L x W x H mm	For shaft dia. mm	Accuracy grade	Order no.	List price EUR
Parallelism tolerance < 0.008 mm, V-grooves and base grinded						
		60 x 120 x 100	8 - 90	0	0508 011	307.00
		75 x 150 x 130	8 - 130	0	0508 012	370.00
	▪	90 x 200 x 170	12 - 180	0	0508 013	542.00
Parallelism tolerance < 0.016 mm, V-grooves and base finely grinded						
		60 x 120 x 100	8 - 90	1	0508 111	266.00
		75 x 150 x 130	8 - 130	1	0508 112	328.00
	▪	90 x 200 x 170	8 - 180	1	0508 113	500.00



0522 V-blocks with clamp



Specification

- Stainless special steel, hardened
- Parallelism from prism to base 0,004 mm
- 2 x 90° grooves

Delivery

- Cardboard box

	Dimensions L x W x H mm	For shaft dia. mm	Order no.	List price EUR
	50 x 40 x 40	5 - 30	0522 201	133.00
	75 x 55 x 55	5 - 50	0522 202	162.00
	100 x 75 x 75	7 - 70	0522 203	233.00

0522 Double V-blocks (pairs) with clamp



Specification

- Stainless special steel, hardened
- Parallelism from prism to base 0.004 mm

Delivery

- 2 x 90° grooves
- Machined in pairs
- In pairs
- Cardboard box

	Dimensions L x W x H mm	For shaft dia. mm	Order no.	List price EUR
Special steel, hardened				
	50 x 40 x 40	5 - 30	0522 101	204.00
	75 x 55 x 55	5 - 50	0522 102	249.00
	100 x 75 x 75	7 - 70	0522 103	359.00
Stainless special steel, hardened				
	50 x 40 x 40	5 - 30	0522 206	253.00
	75 x 55 x 55	5 - 50	0522 207	308.00
	100 x 75 x 75	7 - 70	0522 208	443.00



0524 Double V-blocks (pairs) with clamp lateral tilting



Specification

- Stainless special steel, hardened
- Flatness, parallelism and symmetry tolerance 0.004 mm
- Right-angled tolerance faces to prism 0.01
- 2 x 90° grooves
- Machined in pairs

Delivery

- In pairs
- Cardboard box

		Dimensions mm	For shaft dia. mm	Order no.	List price EUR
		60 x 58 x 40	5 - 30	0524 101	225.00
		75 x 70 x 54	5 - 30	0524 102	278.00
		100 x 96 x 75	7 - 70	0524 103	418.00

0522 Clamp for double V-blocks



Delivery

- In pairs
- Cardboard box

		Suitable for prisms	Order no.	List price EUR
		0522 201 / 0522 101 / 0522 206 / 0524 101	0522 111	32.00
		0522 202 / 0522 102 / 0522 207 / 0524 102	0522 112	37.00
		0522 203 / 0522 103 / 0522 208 / 0524 103	0522 113	45.00



0527 Magnetic measuring and clamping prism





Model

- Flatness, parallelism and symmetry tolerance 0.004 mm
- Right-angled tolerance is 0.01 mm
- Magnet can be switched ON/OFF
- Magnetic force 600 N

Delivery

- Cardboard box

		Dimensions L x W x H mm	For shaft dia. mm	Order no.	List price EUR
Special steel					
		80 x 67 x 99	6 - 66	0527 101	340.00
		100 x 67 x 96	6 - 70	0527 102	471.00
Special steel, hardened					
		71,5 x 45 x 70	2 - 40	0527 106*	275.00
		80 x 67 x 99	6 - 66	0527 107	403.00
		100 x 67 x 96	6 - 70	0527 108	562.00

*with flat base

0527 Magnetic measuring and clamping prism (pairs)

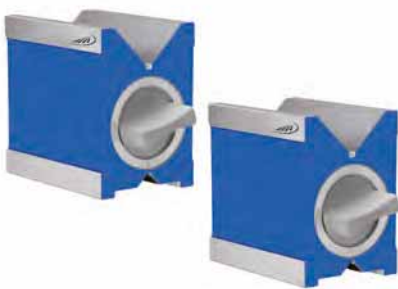



Model

- Grinded in pairs

Delivery

- In pairs
- Cardboard box

		Dimensions L x W x H mm	For shaft dia. mm	Order no.	List price EUR
Special steel					
		80 x 67 x 99	6 - 66	0527 104	668.00
		100 x 67 x 96	6 - 70	0527 105	934.00
Special steel, hardened					
		71,5 x 45 x 70	2 - 40	0527 109*	550.00
		80 x 67 x 99	6 - 66	0527 110	858.00
		100 x 67 x 96	6 - 70	0527 111	1111.00

*with flat base



0527 Magnetic measuring and clamping prism single / pair



0527 151



0527 156

Specification

- Special steel, polished
- Two sided machining
- Prisms 120°
- Parallelism from prism to base 0.008 mm
- Magnet can be switched ON/OFF
- Magnetic force 600 N

Delivery

- Cardboard box
- Packed individually or in pairs

☒	☒	Dimensions L x W x H mm	For shaft dia. mm	Order no.	List price EUR
Single prism					
		70 x 45 x 65	13 - 35	0527 151	180.00
Pair of prisms					
		70 x 45 x 65	13 - 35	0527 156	355.00

0525 Adjustable V-blocks 0-60°



Model

- Special steel, hardened
- Locking device
- Vernier reading

Delivery

- Cardboard box

☒	☒	Dimensions mm	For shaft dia. mm	Order no.	List price EUR
		75 x 25 x 33	4 - 28	0525 101	120.00
		102 x 30 x 46	4 - 40	0525 102	128.00
		102 x 46 x 46	4 - 40	0525 103	137.00



0536 Set of parallel blocks



0536 202

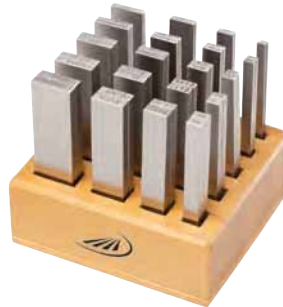

0536 211

Model

- Special steel, hardened

Delivery

- Wooden case

✕	☒	Measuring range mm	Height mm	Width mm	Number of devices	Height tolerance µm	Order no.	List price EUR
Set consists of 9 pairs, length 100 mm								
		10 - 42	10 / 14 / 18 / 22 / 26 / 30 / 34 / 38 / 42	4	9	± 5	0536 220	103.00
Set consists of 9 pairs, length 150 mm								
		10 - 42	10 / 14 / 18 / 22 / 26 30 / 34 / 38 / 42	4	9	± 5	0536 230	141.00
Set consists of 12 pairs, length 120 mm								
		14 - 40	14 / 16 / 18 / 20 22 / 24 / 26 / 28 30 / 32 / 35 / 40	10	12	± 5	0536 201	391.00
Set consists of 14 pairs, length 150 mm								
		14 - 50	14 / 16 / 18 / 20 22 / 24 / 26 / 28 30 / 32 / 35 / 40 45 / 50	10	14	± 5	0536 202	438.00
Set consists of 20 pairs, length 100 mm								
		2 - 24	5 / 10 / 15 / 20 6 / 11 / 16 / 21 7 / 12 / 17 / 22 8 / 13 / 18 / 23 9 / 14 / 19 / 24	2 3 4 5 6	20	± 5	0536 211	546.00
Set consists of 24 pairs, length 125 mm								
		8 - 42	11 / 16 / 21 / 26 / 31 / 36 13 / 18 / 23 / 28 / 33 / 38 15 / 20 / 25 / 30 / 35 / 40 17 / 22 / 27 / 32 / 37 / 42	8 10 12 14	24	± 5	0536 212	645.00
Set consists of 24 pairs, length 150 mm								
		8 - 42	11 / 16 / 21 / 26 / 31 / 36 13 / 18 / 23 / 28 / 33 / 38 15 / 20 / 25 / 30 / 35 / 40 17 / 22 / 27 / 32 / 37 / 42	8 10 12 14	24	± 5	0536 213	650.00



0550 Machine levels

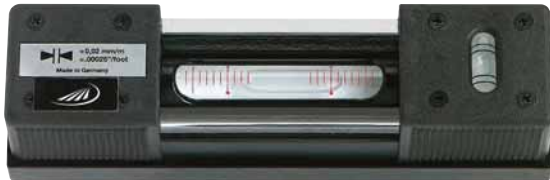

DIN 877

Model

- DIN 877
- V-groove in the base
- Longitudinal level grinded and graduated
- Transverse level
- Thermally insulated

Delivery

- Case

☒	☒	Length mm	Order no.	List price EUR
Reading 0.02 mm/m				
		160	0550 021	282.00
		200	0550 022	309.00
		250	0550 023	337.00
		300	0550 024	365.00
Reading 0.1 mm/m				
		160	0550 101	199.00
		200	0550 102	227.00
		250	0550 103	255.00
		300	0550 104	282.00
Reading 0.3 mm/m				
		160	0550 131	155.00
		200	0550 132	182.00
		250	0550 133	209.00
		300	0550 134	237.00

0556 Frame levels



DIN 877

Model

- DIN 877
- V-grooves on 3 sides
- Longitudinal level
- Grinded and graduated
- Transverse level
- Thermally insulated

Delivery

- Case

☒	☒	Dimensions mm	Order no.	List price EUR
Reading 0.02 mm/m				
		150 x 150	0556 022	542.00
		200 x 200	0556 023	619.00
		300 x 300	0556 024	872.00
Reading 0.1 mm/m				
		100 x 100	0556 101	332.00
		150 x 150	0556 102	387.00
		200 x 200	0556 103	485.00
		300 x 300	0556 104	773.00



0563 Magnetic angle gauge



Model

- Centre punch
- Dial face 360°
- Magnetic 90° splayed base

Delivery

- Cardboard box

	Order no.	List price
	0563 001	EUR 417.00

0580 Combined lathe and thread cutting gauge



Model

- Special steel
- Cuts for trapezoidal (Acme), Whitworth and metric threads

	Dimensions	Measuring range	Order no.	List price
	mm 90 x 40 x 2	in ° 40-80°	0580 101	EUR 7.40

0580 Combined lathe and thread cutting gauge



Model

- Special steel
- Cuts for trapezoidal (Acme), Whitworth and metric threads
- With clearance angle

	Dimensions	Measuring range	Order no.	List price
	mm 90 x 40 x 2	in ° 0-30° and 40-80°	0580 111	EUR 10.70



0580 Combined lathe and thread cutting gauge



Model

- Special steel
- For square threads and trapezoidal threads, Whitworth and metric threads

	Dimensions mm	Order no.	List price EUR
	90 x 40 x 2	0580 121	7.50

0580 Universal thread cutting gauge



Model

- Special steel
- For V-threads and square threads

	Dimensions mm	Order no.	List price EUR
	60 x 25 x 2	0580 151	3.10

0595 ACME Thread gauge



Model

- Special steel
- Cuts for trapezoidal threads

	Dimensions mm	Type of thread	Order no.	List price EUR
	60 x 20 x 2	Trapezoidal threads	0595 130	3.10

0595 Thread cutting gauge



Model

- Special steel
- Cuts for Whitworth or metric threads

	Dimensions mm	Type of thread	Order no.	List price EUR
Metric ISO - threads 60°				
	74 x 24 x 2	Whitworth-thread	0595 142	2.70
Whitworth - threads 55°				
	74 x 24 x 2	Whitworth-thread	0595 140	2.70



0581 DIN thread conversion and fit slide rules



0581 101

Model

- For reading the most important theoretical dimensions of thread tolerance



0581 123

	Description	Order no.	List price EUR
Aluminium anodized			
	Fine thread slide rule	0581 101	21.60
	DIN thread slide rule	0581 103	14.60
	DIN fit slide rule	0581 105	20.00
Plastic			
	DIN thread slide rule	0581 123	10.50
	DIN fit slide rule	0581 125	9.20





0582 ISO thread converter - Filetor



Model

- For direct reading of all standard information for determining of threads
- Plastic housing

		Dimensions	Order no.	List price
		mm		EUR
		60 x 30 x 110	0582 110	66.00

0582 ISO tolerance indicator - Tolerator



Model

- For direct reading of all standard information of all ISO-tolerance values
- Plastic housing

		Dimensions	Order no.	List price
		mm		EUR
		60 x 30 x 110	0582 120	66.00

0582 mm/inch converter



Model

- Direct reading of inch to millimeter conversion
- Plastic housing

		Dimensions	Order no.	List price
		mm		EUR
		60 x 30 x 110	0582 130	66.00



0589 Profile gauge



Model

- Spring pins
- Pin-dia. 1.0 mm

		Dimensions mm	Order no.	List price EUR
		154 x 85	0589 101	16.90
		350 x 150	0589 103	52.00

0590 Twist drill grinding gauge



Model

- Special steel
- For twist drills
- Acute angle of 118°

		Max dia. mm	Order no.	List price EUR
		50	0590 101	1.80



0590 Universal grinding gauge



Model

- Special steel
- Scales in mm graduation
- Angles 120°, 120°, 90°, 60° and 55°

⌘	☒	Dimensions mm	Order no.	List price EUR
		95 x 63 x 2	0590 151	3.40

0595 Welding gauge blank



Model

- Special steel
- Pure
- For easy testing of fillet weld thicknesses of rectangular parts

⌘	☒	For measuring range mm	Order no.	List price EUR
		3 - 12	0595 110	13.20



0595 Welding gauge

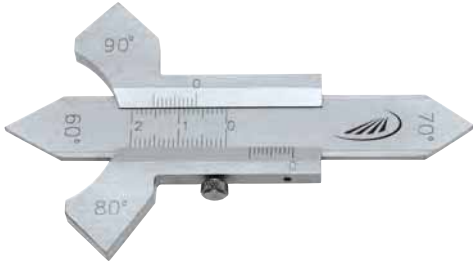

Ausführung

- Special steel
- Locking screw
- Angel 60°, 70°, 80° and 90°
- to measure the height of flat welds and fillet weld thicknesses

	For measuring range	Reading	Order no.	List price
	mm	mm		EUR
	20 mm	0,10	0595 101	21.20

0595 Welding gauge blank



Model

- Aluminium
- Pure, for fast reading of the weld dimensions

	For measuring range	Order no.	List price
	mm		EUR
	0 - 5	0595 115	3.80

0595 Welding gauge



Model

- Stainless steel
- Reading accuracy 0.2 mm
- Easy to read the result due to the reference line in the reading window
- Quick and easy inspection of welding seam heights

	Dimensions	Order no.	List price
	mm		EUR
	108 x 81.5 x 3.2	0595 251	91.00



0597 Radius gauge



Model

- To determine radius size work-pieces
- Stainless steel
- Reading parts are satin chrome finished

Delivery

- Wooden case
- Interchangeable blade: 45°

Measuring range mm	Reading mm	Order no.	List price EUR
0 - 10	0.10	0597 305	175.00

0597 Chamfer gauge



Model

- Stainless steel
- Reading parts are satin chrome finished
- For simultaneously testing of the chamfer angle and the dimensional accuracy
- Dimensions: 48 x 30 x 8.5 mm

Delivery

- Wooden case
- 3 interchangeable blades: 30°, 45°, 60°

Measuring range mm	Reading mm	Order no.	List price EUR
0 - 10	0.10	0597 301	175.00

0600 Tapered hole gauges



0600 101



0600 111

Model

- Reading 0.1 mm

Measuring range mm	Order no.	List price EUR
Special steel, flat		
1 - 15	0600 101	25.80
15 - 30	0600 102	32.30
30 - 45	0600 103	34.60
Hardened stainless steel, satin chrome finished, round, knurled handle		
1 - 6	0600 111	55.00
4 - 15	0600 112	73.00
15 - 30	0600 113	152.00
30 - 45	0600 114	237.00
45 - 60	0600 115	380.00



0598 Tapered hole gauges



Model

- Special steel
- Reading parts matted

	Measuring range mm	Reading mm	Order no.	List price EUR
Special steel				
	0.5 - 7.0	0.10	0598 103	48.80
	2.0 - 7.0	0.10	0598 105	48.80
Plastic				
	0.5 - 11	0.10	0598 601	48.80

0599 Nozzle / small hole gauges



Model

- Special steel
- Cone 1:10
- Nickel plated housing

	Measuring range mm	Reading mm	Order no.	List price EUR
	0 - 5	0.01	0599 102	59.00

0599 Nozzle gauges

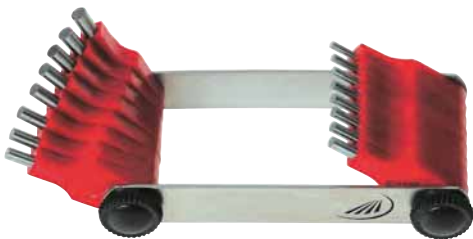

Model

- With steel pins
- Plastic handle
- Manufacturing tolerance ± 0.01 mm

	Measuring range mm	Increment mm	Number of pairs	Order no.	List price EUR
	0.45 - 1.5	0.05	20	0599 151	7.10
	1.5 - 3.0	0.1	16	0599 152	7.10



0601 Drill and steel wire hole gauges (millimeter)

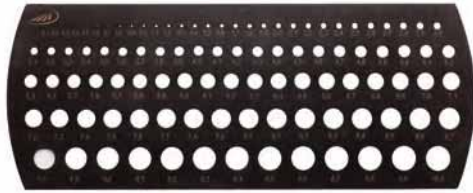

Model

- Special steel, nitrided

⌘	☒	Measuring range mm	Increment mm	Order no.	List price EUR
		0.1 - 10	0.1	0601 103	91.00
		3.0 - 10	0.1	0601 120	69.00

0604 Radius gauges



Model

- Concave and convex
- Locking nut
- Milled finish

⌘	☒	Measuring range mm	Number of blades	Order no.	List price EUR
Special steel					
		1.0 - 7.0	17	0604 002	6.80
		7.5 - 15	16	0604 004	7.50
		15.5 - 25	15	0604 006	7.50
Stainless steel					
		1.0 - 7.0	17	0604 202	9.00
		7.5 - 15	16	0604 204	11.10
		15.5 - 25	15	0604 206	11.10



0605 Screw pitch gauges



Measuring range mm	Number of blades	Description	Order no.	List price EUR
0.25 - 6.0	24	Metric threads according to ISO	0605 101	2.50
0.40 - 7.0	20	Combined metric threads according to SI System	0605 102	2.30
4.00 - 62.0	28	Whitworth threads according to DIN	0605 103	2.30
8.00 - 28.0	6	Whitworth pipe threads	0605 104	2.30
0.40 - 7.0 / 4.0 - 62.0	48	Combined metric SI and Whitworth threads	0605 105	3.40
0.25 - 6.0 / 4.0 - 62.0	52	Combined metric and Whitworth threads	0605 106	3.60
0.25 - 6.0 / 4.0 - 62.0 / 8.0 - 28.0	58	Metric Whitworth and pipe threads	0605 107	5.10
4.00 - 42.0	30	US - threads	0605 108	3.00
10.0 - 40.0	14	US - threads SAE	0605 109	3.20
4.00 - 64.0	22	UNC - threads	0605 110	3.00
12.0 - 80.0	16	UNF - threads	0605 111	3.00
4.00 - 26.0	20	BSF - threads	0605 112	3.40

0606 / 0607 Feeler gauges



0606 121



0607 201



0607 401

Model

- Conical blades
- Width 10mm
- Blade length 100 mm
- Locking nut

Measuring range mm	Number of blades	Order no.	List price EUR
Spring band steel			
0.03 - 0.1	8	0606 121	1.60
0.05 - 0.5	8	0606 123	1.60
0.05 - 1.0	13	0606 127	1.60
0.05 - 1.0	20	0606 130	2.50
0.1 - 0.5	21	0606 132	3.00
0.05 - 2.0	21	0606 133	5.60
0.03 - 1.0	32	0606 136	5.10
Stainless spring band steel			
0.05 - 0.5	8	0607 201	3.90
0.05 - 1.0	13	0607 202	6.10
0.05 - 1.0	20	0607 203	8.80
Brass (anti-magnetic)			
0.05 - 0.5	8	0607 401	6.60
0.05 - 1.0	13	0607 402	8.10
0.05 - 1.0	20	0607 403	11.60



0606 Feeler gauges, long version



Model

- Cylindrical blades
- Width 13 mm

Measuring range	Length	Number of blades	Order no.	List price
mm	mm			EUR
0.05 - 0.5	150	8	0606 150	3.40
0.05 - 0.5	200	8	0606 152	4.10
0.05 - 0.5	300	8	0606 154	5.90
0.05 - 1.0	200	13	0606 160	8.90
0.05 - 1.0	300	13	0606 162	10.20
0.05 - 1.0	200	20	0606 170	10.70
0.05 - 1.0	300	20	0606 172	13.50
0.1 - 2.0	200	20	0606 176	17.90
0.1 - 2.0	300	20	0606 178	26.20

0608 Feeler gauges, accuracy grade T3



Model

- Conical blades
- Width 10 mm

Measuring range	Number of blades	Order no.	List price
mm			EUR
0.1 - 0.4	6	0608 140	1.90
0.05 - 1.0	13	0608 143	4.60
0.05 - 1.0	20	0608 144	7.20
0.03 - 1.0	32	0608 149	16.60



0612 Feeler gauge tapes in single boxes - INOX



Model

- Stainless steel
- Width 12.7 mm
- Length 5 m
- Tape from 0.08 mm upwards marked with dimension

Delivery

- Plastic box

✕	☒	Nominal size mm	Order no.	List price EUR
		0.01	0612 501	45.00
		0.02	0612 502	34.50
		0.03	0612 503	15.00
		0.04	0612 504	15.00
		0.05	0612 505	13.00
		0.06	0612 506	11.00
		0.07	0612 507	11.00
		0.08	0612 508	11.00
		0.09	0612 509	11.00
		0.10	0612 510	11.00
		0.12	0612 512	11.00
		0.15	0612 515	11.00
		0.18	0612 518	11.00
		0.20	0612 520	11.00
		0.25	0612 525	11.00

0612 Set of feeler gauge tapes in wallholder - INOX



Model

- Refillable with selected feeler gauges
- Wall holder made of steel, gloss coated
- With size labels

Delivery

- With holder and mounting fittings

✕	☒	Dimensions mm	Measuring range mm	Number of boxes	Order no.	List price EUR
		330 x 100 x 110	0.01 - 0.25	15	0612 180	252.00

0611 Accessories for feeler gauge tapes



0611 195



0611 197



0611 198

✕	☒	Description	Dimensions mm	Order no.	List price EUR
		Holder for feeler gauge tape	125 x 17	0611 195	3.00
		Wallholder for 0.01 - 0.25 mm	330 x 100 x 110	0611 197	39.00
		Wallholder for 0.3 - 1.0 mm	330 x 210 x 220	0611 198	59.00



0611 Feeler gauge tapes in single boxes



Model

- Hardened carbon steel
- Width 12.7 mm
- Length 5 m
- Tape from 0.08 mm upwards marked with dimension

Delivery

- Plastic box

☒	☒	Nominal size mm	Order no.	List price EUR
		0.005	0611 300	79.00
		0.01	0611 501	45.00
		0.02	0611 502	34.50
		0.03	0611 503	13.00
		0.04	0611 504	13.00
		0.05	0611 505	11.00
		0.06	0611 506	9.50
		0.07	0611 507	9.50
		0.08	0611 508	9.50
		0.09	0611 509	9.50
		0.10	0611 510	9.50
		0.12	0611 512	9.50
		0.15	0611 515	9.50
		0.18	0611 518	9.50
		0.20	0611 520	9.50
		0.25	0611 525	9.50
		0.30	0611 530	9.50
		0.35	0611 535	11.00
		0.40	0611 540	11.00
		0.45	0611 545	11.00
		0.50	0611 550	11.00
		0.55	0611 552	16.50
		0.60	0611 554	16.50
		0.65	0611 556	16.50
		0.70	0611 558	16.50
		0.75	0611 560	16.50
		0.80	0611 562	16.50
		0.85	0611 564	16.50
		0.90	0611 566	17.50
		0.95	0611 568	17.50
		1.0	0611 570	17.50

0611 Set of feeler gauge tapes in wallholder



Model

- Refillable with selected feeler gauges
- Wall holder made of steel, gloss coated
- With size labels

Delivery

- With holder and mounting fittings

☒	☒	Dimensions mm	Measuring range mm	Number of boxes	Order no.	List price EUR
		330 x 100 x 110	0.01 - 0.25	15	0611 180	231.00
		330 x 210 x 220	0.3 - 1.0	15	0611 190	251.00



0613 Precision reference sheets



0613 607



0613 709



0613 812

Nominal size mm	Carbon steel, 50 x 300 mm, 10 pieces		Stainless steel, 100 x 500 mm, 5 pieces		Stainless steel, 150 x 500 mm, 5 pieces	
	Order no.	List price EUR	Order no.	List price EUR	Order no.	List price EUR
0.01	0613 607	68.00				
0.02	0613 609	36.70	0613 709	51.00		
0.025					0613 812	56.00
0.03	0613 614	25.80				
0.04	0613 616	25.80				
0.05	0613 618	25.80	0613 718	30.60	0613 818	45.50
0.06	0613 620	17.60				
0.07	0613 622	17.60				
0.075					0613 824	45.50
0.08	0613 626	17.60				
0.09	0613 628	17.60				
0.10	0613 630	18.20	0613 730	28.70	0613 830	43.10
0.12	0613 632	18.20				
0.15	0613 634	18.20	0613 734	28.70	0613 834	43.10
0.18	0613 636	18.20				
0.20	0613 638	18.20	0613 738	36.20	0613 838	54.00
0.25	0613 640	18.20			0613 840	54.00
0.30	0613 642	18.20	0613 742	36.20	0613 842	54.00
0.35	0613 644	20.20				
0.40	0613 646	20.20	0613 746	40.80	0613 846	63.00
0.45	0613 648	20.20				
0.50	0613 650	20.20	0613 750	46.70	0613 850	73.00
0.60	0613 652	32.30	0613 752	56.00		
0.70	0613 654	32.30	0613 754	56.00		
0.80	0613 656	32.30	0613 756	68.00		
0.90	0613 658	32.30	0613 758	68.00		
1.00	0613 660	32.30	0613 760	75.00	0613 860	118.00



0613 Feeler gauge tapes



Nominal size mm	Carbon steel, width 25 mm length 5 m		Carbon steel, width 50 mm length 5 m		Stainless steel, width 100 mm length 5 m		Stainless steel, width 150 mm length 5 m	
	Order no.	List price EUR	Order no.	List price EUR	Order no.	List price EUR	Order no.	List price EUR
0.01	0613 107	68.00	0613 207	98.00				
0.02	0613 109	36.70	0613 209	53.00	0613 309	94.00		
0.025							0613 412	107.00
0.03	0613 114	25.80	0613 214	37.10				
0.04	0613 116	25.80	0613 216	37.10				
0.05	0613 118	25.80	0613 218	37.10	0613 318	56.00	0613 418	86.00
0.06	0613 120	17.60	0613 220	25.30				
0.07	0613 122	17.60	0613 222	25.30				
0.075							0613 424	86.00
0.08	0613 126	17.60	0613 226	25.30				
0.09	0613 128	17.60	0613 228	25.30				
0.10	0613 130	18.20	0613 230	26.30	0613 330	53.00	0613 430	82.00
0.12			0613 232	26.30				
0.15	0613 134	18.20	0613 234	26.30	0613 334	53.00	0613 434	82.00
0.18			0613 236	26.30				
0.20	0613 138	18.20	0613 238	26.30	0613 338	68.00	0613 438	103.00
0.25			0613 240	26.30			0613 440	103.00
0.30	0613 142	18.20	0613 242	26.30	0613 342	68.00	0613 442	103.00
0.35			0613 244	28.70				
0.40	0613 146	20.20	0613 246	28.70	0613 346	77.00	0613 446	114.00
0.45			0613 248	28.70				
0.50	0613 150	20.20	0613 250	28.70	0613 350	88.00	0613 450	133.00
0.60	0613 152	32.30	0613 252	46.70	0613 352	105.00		
0.70	0613 154	32.30	0613 254	46.70	0613 354	105.00		
0.80	0613 156	32.30	0613 256	46.70	0613 356	126.00		
0.90	0613 158	32.30	0613 258	46.70	0613 358	126.00		
1.00	0613 160	32.30	0613 260	46.70	0613 360	144.00		



0609 8 piece gauge set



Model

- Universal grinding gauge – thickness 2 mm, scales in mm graduation, angles 120°, 118°, 90°, 60° and 55°, special steel
- Welding gauge – measuring range 20 mm, reading 0.1mm, locking screw, special steel
- Radius gauge – 17 blades, concave and convex, locking nut, stainless steel, measuring range 1.0 – 7.0 mm
- Radius gauge – 16 blades, concave and convex, locking nut, stainless steel, measuring range 7.5 – 15.0 mm
- Radius gauge – 15 blades, concave and convex, locking nut, stainless steel, measuring range 15.5 – 25.0 mm
- Screw pitch gauge – 24 blades, for metric threads according to ISO, range 0.25 – 6.0 mm
- Screw pitch gauge – 28 blades, for Whitworth threads according to DIN, range 4.0 - 62.0 mm
- Feeler gauge - 20 conical blades, length 100 mm, range 0.05 - 1.00, stainless steel, locking nut

Delivery

- Wooden box set

	Order no.	List price
	0609 190	EUR 82.00

0584 Comparative surface roughness standards

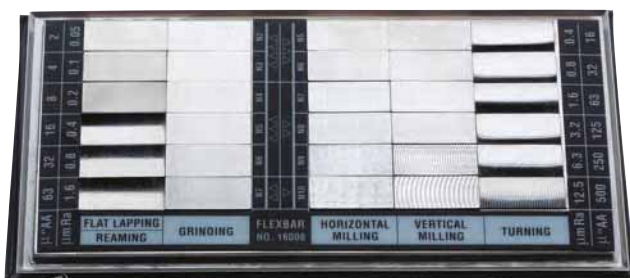

Model

- 6 manufacturing processes
- 30 comparative standards

Delivery

- Plastic case

	Order no.	List price
	0584 101	EUR 317.00



0623 Individual steel gauge blocks, tolerance class 0



Model

- EN ISO 3650
- Special steel, hardened

Nominal size mm	Order no.	List price EUR
0.5	0623 100	42.20
1.0	0623 102	35.70
1.10	0623 170	35.70
1.20	0623 220	35.70
1.30	0623 270	35.70
1.40	0623 320	35.70
1.50	0623 370	35.70
1.60	0623 375	35.70
1.70	0623 380	35.70
1.80	0623 385	35.70
1.90	0623 390	35.70
2.00	0623 395	35.70
2.50	0623 400	37.90
3.00	0623 405	37.90
3.50	0623 410	37.90
4.00	0623 415	37.90
4.50	0623 420	37.90
5.00	0623 425	37.90
5.50	0623 430	37.90
6.00	0623 435	37.90
6.50	0623 440	37.90
7.00	0623 445	37.90
7.50	0623 450	37.90
8.00	0623 455	37.90
8.50	0623 460	37.90
9.00	0623 465	37.90
9.50	0623 470	37.90
10.00	0623 475	45.40
11.00	0623 500	45.40

Nominal size mm	Order no.	List price EUR
12.00	0623 510	45.40
13.00	0623 520	45.40
14.00	0623 530	45.40
15.00	0623 540	45.40
16.00	0623 550	45.40
17.00	0623 560	45.40
18.00	0623 570	45.40
19.00	0623 580	45.40
20.00	0623 590	45.40
21.00	0623 600	45.40
22.00	0623 610	45.40
23.00	0623 620	45.40
24.00	0623 630	45.40
25.00	0623 640	45.40
30.00	0623 650	54.00
40.00	0623 670	54.00
50.00	0623 680	54.00
60.00	0623 690	54.00
70.00	0623 700	54.00
80.00	0623 710	67.00
90.00	0623 720	67.00
100.00	0623 730	80.00
125.00	0623 740	283.00
150.00	0623 750	283.00
175.00	0623 760	283.00
200.00	0623 770	338.00
300.00	0623 780	482.00
400.00	0623 790	626.00
500.00	0623 800	866.00



0624 Individual steel gauge blocks, tolerance class 1



Model

- EN ISO 3650
- Special steel, hardened

Nominal size mm	Order no.	List price EUR
0.5	0624 100	28.10
1.0	0624 102	23.90
1.001	0624 104	23.90
1.002	0624 106	23.90
1.003	0624 108	23.90
1.004	0624 110	23.90
1.005	0624 112	23.90
1.006	0624 114	23.90
1.007	0624 116	23.90
1.008	0624 118	23.90
1.009	0624 120	23.90
1.01	0624 122	23.90
1.02	0624 130	23.90
1.03	0624 135	23.90
1.04	0624 140	23.90
1.05	0624 145	23.90
1.06	0624 150	23.90
1.07	0624 155	23.90
1.08	0624 160	23.90
1.09	0624 165	23.90
1.10	0624 170	23.90
1.11	0624 175	23.90
1.12	0624 180	23.90
1.13	0624 185	23.90
1.14	0624 190	23.90
1.15	0624 195	23.90
1.16	0624 200	23.90
1.17	0624 205	23.90
1.18	0624 210	23.90
1.19	0624 215	23.90
1.20	0624 220	23.90
1.21	0624 225	23.90
1.22	0624 230	23.90
1.23	0624 235	23.90
1.24	0624 240	23.90
1.25	0624 245	23.90
1.26	0624 250	23.90
1.27	0624 255	23.90
1.28	0624 260	23.90
1.29	0624 265	23.90

Nominal size mm	Order no.	List price EUR
1.30	0624 270	23.90
1.31	0624 275	23.90
1.32	0624 280	23.90
1.33	0624 285	23.90
1.34	0624 290	23.90
1.35	0624 295	23.90
1.36	0624 300	23.90
1.37	0624 305	23.90
1.38	0624 310	23.90
1.39	0624 315	23.90
1.40	0624 320	23.90
1.41	0624 325	23.90
1.42	0624 330	23.90
1.43	0624 335	23.90
1.44	0624 340	23.90
1.45	0624 345	23.90
1.46	0624 350	23.90
1.47	0624 355	23.90
1.48	0624 360	23.90
1.49	0624 365	23.90
1.50	0624 370	23.90
1.60	0624 375	23.90
1.70	0624 380	23.90
1.80	0624 385	23.90
1.90	0624 390	23.90
2.00	0624 395	23.90
2.50	0624 400	24.90
3.00	0624 405	24.90
3.50	0624 410	24.90
4.00	0624 415	24.90
4.50	0624 420	24.90
5.00	0624 425	24.90
5.50	0624 430	24.90
6.00	0624 435	24.90
6.50	0624 440	24.90
7.00	0624 445	24.90
7.50	0624 450	24.90
8.00	0624 455	24.90
8.50	0624 460	24.90
9.00	0624 465	24.90

Nominal size mm	Order no.	List price EUR
9.50	0624 470	24.90
10.00	0624 475	30.30
11.00	0624 500	30.30
12.00	0624 510	30.30
13.00	0624 520	30.30
14.00	0624 530	30.30
15.00	0624 540	30.30
16.00	0624 550	30.30
17.00	0624 560	30.30
18.00	0624 570	30.30
19.00	0624 580	30.30
20.00	0624 590	30.30
21.00	0624 600	30.30
22.00	0624 610	30.30
23.00	0624 620	30.30
24.00	0624 630	30.30
25.00	0624 640	30.30
30.00	0624 650	35.70
35.00	0624 660	35.70
40.00	0624 670	35.70
50.00	0624 680	35.70
60.00	0624 690	35.70
70.00	0624 700	35.70
80.00	0624 710	44.40
90.00	0624 720	44.40
100.00	0624 730	53.00
125.00	0624 740	172.00
150.00	0624 750	172.00
175.00	0624 760	172.00
200.00	0624 770	204.00
300.00	0624 780	293.00
400.00	0624 790	379.00
500.00	0624 800	525.00



0625 Individual steel gauge blocks, tolerance class 2



Model

- EN ISO 3650
- Special steel, hardened

Nominal size mm	Order no.	List price EUR
0.5	0625 100	22.70
1.0	0625 102	19.50
1.001	0625 104	19.50
1.002	0625 106	19.50
1.003	0625 108	19.50
1.004	0625 110	19.50
1.005	0625 112	19.50
1.006	0625 114	19.50
1.007	0625 116	19.50
1.008	0625 118	19.50
1.009	0625 120	19.50
1.01	0625 122	19.50
1.02	0625 130	19.50
1.03	0625 135	19.50
1.04	0625 140	19.50
1.05	0625 145	19.50
1.06	0625 150	19.50
1.07	0625 155	19.50
1.08	0625 160	19.50
1.09	0625 165	19.50
1.10	0625 170	19.50
1.11	0625 175	19.50
1.12	0625 180	19.50
1.13	0625 185	19.50
1.14	0625 190	19.50
1.15	0625 195	19.50
1.16	0625 200	19.50
1.17	0625 205	19.50
1.18	0625 210	19.50
1.19	0625 215	19.50
1.20	0625 220	19.50
1.21	0625 225	19.50
1.22	0625 230	19.50
1.23	0625 235	19.50
1.24	0625 240	19.50
1.25	0625 245	19.50
1.26	0625 250	19.50
1.27	0625 255	19.50
1.28	0625 260	19.50
1.29	0625 265	19.50

Nominal size mm	Order no.	List price EUR
1.30	0625 270	19.50
1.31	0625 275	19.50
1.32	0625 280	19.50
1.33	0625 285	19.50
1.34	0625 290	19.50
1.35	0625 295	19.50
1.36	0625 300	19.50
1.37	0625 305	19.50
1.38	0625 310	19.50
1.39	0625 315	19.50
1.40	0625 320	19.50
1.41	0625 325	19.50
1.42	0625 330	19.50
1.43	0625 335	19.50
1.44	0625 340	19.50
1.45	0625 345	19.50
1.46	0625 350	19.50
1.47	0625 355	19.50
1.48	0625 360	19.50
1.49	0625 365	19.50
1.50	0625 370	19.50
1.60	0625 375	19.50
1.70	0625 380	19.50
1.80	0625 385	19.50
1.90	0625 390	19.50
2.00	0625 395	19.50
2.50	0625 400	19.50
3.00	0625 405	19.50
3.50	0625 410	19.50
4.00	0625 415	19.50
4.50	0625 420	19.50
5.00	0625 425	19.50
5.50	0625 430	19.50
6.00	0625 435	19.50
6.50	0625 440	19.50
7.00	0625 445	19.50
7.50	0625 450	19.50
8.00	0625 455	19.50
8.50	0625 460	19.50
9.00	0625 465	19.50

Nominal size mm	Order no.	List price EUR
9.50	0625 470	19.50
10.00	0625 475	23.90
11.00	0625 500	23.90
12.00	0625 510	23.90
13.00	0625 520	23.90
14.00	0625 530	23.90
15.00	0625 540	23.90
16.00	0625 550	23.90
17.00	0625 560	23.90
18.00	0625 570	23.90
19.00	0625 580	23.90
20.00	0625 590	23.90
21.00	0625 600	23.90
22.00	0625 610	23.90
23.00	0625 620	23.90
24.00	0625 630	23.90
25.00	0625 640	23.90
30.00	0625 650	28.10
35.00	0625 660	28.10
40.00	0625 670	28.10
50.00	0625 680	28.10
60.00	0625 690	28.10
70.00	0625 700	28.10
80.00	0625 710	35.70
90.00	0625 720	35.70
100.00	0625 730	42.20
125.00	0625 740	138.00
150.00	0625 750	138.00
175.00	0625 760	138.00
200.00	0625 770	147.00
300.00	0625 780	232.00
400.00	0625 790	273.00
500.00	0625 800	357.00



0633 Gauge block holders with rapid adjustment



☒	☒	Measuring range mm	Order no.	List price EUR
		0 - 50	0633 136	182.00
		0 - 100	0633 137	208.00
		0 - 200	0633 138	250.00
		100 - 200	0633 139	229.00
		100 - 300	0633 140	271.00
		200 - 400	0633 141	313.00
		300 - 500	0633 142	354.00
		400 - 600	0633 143	386.00
		500 - 800	0633 144	448.00
		800 - 1000	0633 145	625.00

0633 Radiused measuring jaws with cylindrical shoulders / pair



☒	☒	Nominal size mm	Measuring depth mm	Order no.	List price EUR
		4	8	0633 150	214.00
		10	15	0633 151	214.00
		16	20	0633 152	229.00
		20	40	0633 153	281.00
		30	65	0633 154	396.00
		40	95	0633 155	516.00

0633 Plane / parallel jaws, pair



Model

- For external measurement

☒	☒	Dimensions mm	Order no.	List price EUR
For external measurements				
		100 x 9 x 20	0633 174	208.00
		125 x 9 x 20	0633 175	245.00
For internal and external measurements				
		100 x 9 x 20	0633 176	386.00
		125 x 9 x 20	0633 177	458.00

0633 Stand for gauge block holder

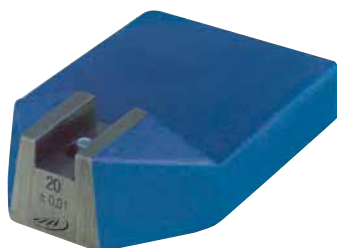

Model

- Special steel, hardened

☒	☒	Dimensions mm	Order no.	List price EUR
		103 x 70 x 27	0633 182	162.00



0633 Gauge block maintenance set



Model

- Set consists of:
- Linen cloth
 - Chamois leather
 - 1 jar of anti corrosion oil
 - Oil stone
 - Fine paint brush
 - Broad paint brush
 - User manual

Delivery

- Wooden case

Order no.	List price EUR
0633 001	314.00

0633 Steel gauge block inspection sets for micrometers



Model

- EN ISO 3650
- Special steel, hardened
- Tolerance class 1

Delivery

- Wooden case

Max. nominal size mm	Order no.	List price EUR
10 pieces, excludes the optical flat		
2.5 / 5.1 / 7.7 / 10.3 / 12.9 / 15.0 / 17.6 / 20.2 / 22.8 / 25.0	0633 810	275.00
5 pieces with optical flat		
5.1 / 10.3 / 15.0 / 20.2 / 25.0	0633 805	339.00
8 pieces with optical flat		
5.1 / 10.3 / 15.0 / 20.2 / 25.0 / 50.0 / 75.0 / 100	0633 808	453.00

0633 Steel gauge block inspection set for calipers



Model

- EN ISO 3650
- Special steel, hardened
- Tolerance class 1
- Supplied with setting rings 4 mm and 25 mm

Delivery

- Wooden case

For measuring range mm	Max. nominal size mm	Order no.	List price EUR
3 pieces			
200	30.0 / 41.3 / 131.4	0633 833	563.00
4 pieces			
300	30.0 / 41.3 / 131.4 / 243.5	0633 834	751.00
6 pieces			
500	30.0 / 41.3 / 131.4 / 243.5 / 281.2 / 481.1	0633 836	1341.00
5 pieces			
1000	131.4 / 243.5 / 281.2 / 481.1 / 900	0633 838	2371.00



0633 Parallel steel gauge block sets



Model

- EN ISO 3650
- Special steel, hardened

Delivery

- Wooden case

	Number of gauge blocks	Max. nominal size mm	Increment mm	Order no.	List price EUR
Tolerance class 0					
	103	1.005 1.01 - 1.49 0.5 - 24.5 25.0 - 100.0	- 0.01 0.5 25	0633 014	889.00
	87	1.001 - 1.009 1.01 - 1.49 0.5 - 9.5 10.0 - 100.0	0.001 0.01 0.5 10	0633 016	812.00
	47	1.005 1.01 - 1.09 1.11 - 1.19 1.1 - 1.9 1.0 - 9.0 10.0 - 100.0	- 0.01 0.01 0.1 1 10	0633 018	528.00
	32	1.005 1.01 - 1.09 1.1 - 1.9 1.0 - 9.0 10.0 - 30.0 50.0	- 0.01 0.1 1 10 -	0633 020	386.00
Tolerance class 1					
	103	1.005 1.01 - 1.49 0.5 - 24.5 25.0 - 100.0	- 0.01 0.5 25	0633 114	684.00
	87	1.001 - 1.009 1.01 - 1.49 0.5 - 9.5 10.0 - 100.0	0.001 0.01 0.5 10	0633 116	521.00
	47	1.005 1.01 - 1.09 1.11 - 1.19 1.1 - 1.9 1.0 - 9.0 10.0 - 100.0	- 0.01 0.01 0.1 1 10	0633 118	322.00
	32	1.005 1.01 - 1.09 1.1 - 1.9 1.0 - 9.0 10.0 - 30.0 50.0	- 0.01 0.1 1 10 -	0633 120	234.00



0633 Parallel steel gauge block sets



Model

- EN ISO 3650
- Special steel, hardened

Delivery

- Wooden case

		Number of gauge blocks	Max. nominal size mm	Increment mm	Order no.	List price EUR
Tolerance class 2						
		103	1.005 1.01 - 1.49 0.5 - 24.5 25.0 - 100.0	- 0.01 0.5 25	0633 214	432.00
		87	1.001 - 1.009 1.01 - 1.49 0.5 - 9.5 10.0 - 100.0	0.001 0.01 0.5 10	0633 216	341.00
		47	1.005 1.01 - 1.09 1.11 - 1.19 1.1 - 1.9 1.0 - 9.0 10.0 - 100.0	- 0.01 0.01 0.1 1 10	0633 218	233.00
		32	1.005 1.01 - 1.09 1.1 - 1.9 1.0 - 9.0 10.0 - 30.0 50.0	- 0.01 0.1 1 10 -	0633 220	154.00





0636 Pin gauge holder



Model

- Die cast
- With locking screw

		Measuring range mm	Length mm	Order no.	List price EUR
		1 - 2	60	0636 392	13.20
		2 - 4	68	0636 393	15.10
		4 - 6	76	0636 394	28.70
		6 - 8	84	0636 395	36.80
		8 - 10	92	0636 396	42.40



0636 Set of pin gauges



Model

- DIN 2269
- Made out of high quality gauge steel

Delivery

- Wooden case

DIN
2269

☒	☒	Length mm	Number of pins	Max. nominal size mm	Increment mm	Order no.	List price EUR
Special steel, hardened and aged - Tolerance class 1							
		40	51	0.5 - 1.0	0.01	0636 301	812.00
		70	21	1.0 - 2.0	0.05	0636 321	246.00
		70	21	2.0 - 3.0	0.05	0636 322	246.00
		70	21	3.0 - 4.0	0.05	0636 323	304.00
		70	21	4.0 - 5.0	0.05	0636 324	304.00
		70	21	5.0 - 6.0	0.05	0636 325	304.00
		70	21	6.0 - 7.0	0.05	0636 326	371.00
		70	21	7.0 - 8.0	0.05	0636 327	371.00
		70	21	8.0 - 9.0	0.05	0636 328	371.00
		70	21	9.0 - 10.0	0.05	0636 329	371.00
		70	101	1.0 - 2.0	0.01	0636 341	1034.00
		70	100	2.01 - 3.0	0.01	0636 342	1034.00
		70	100	3.01 - 4.0	0.01	0636 343	1310.00
		70	100	4.01 - 5.0	0.01	0636 344	1310.00
		70	100	5.01 - 6.0	0.01	0636 345	1310.00
		70	100	6.01 - 7.0	0.01	0636 346	1612.00
		70	100	7.01 - 8.0	0.01	0636 347	1612.00
		70	100	8.01 - 9.0	0.01	0636 348	1612.00
		70	100	9.01 - 10.0	0.01	0636 349	1612.00
		70	91	1.0 - 10.0	0.1	0636 351	1321.00
		70	81	1.0 - 5.0	0.05	0636 352	1200.00
Special steel, hardened and aged - Tolerance class 2							
		70	101	1.0 - 2.0	0.01	0636 372	723.00
		70	100	2.01 - 3.0	0.01	0636 373	723.00
		70	100	3.01 - 4.0	0.01	0636 374	952.00
		70	100	4.01 - 5.0	0.01	0636 375	952.00
		70	100	5.01 - 6.0	0.01	0636 376	952.00
		70	100	6.01 - 7.0	0.01	0636 377	1153.00
		70	100	7.01 - 8.0	0.01	0636 378	1308.00
		70	100	8.01 - 9.0	0.01	0636 379	1308.00
		70	100	9.01 - 10.0	0.01	0636 380	1308.00



0643 Snap gauge, double jaw



Model

- Dimensions 3 to 100 mm
- Gauge steel
- Hardened measuring faces
- Dimensions acc. DIN 2230
- Manufacturing tolerances: according to DIN 7163

Delivery

- Available on request
- Important: Please mention dimension and fit

0649 Adjustable snap gauges



Model

- Special cast iron
- 1 fixed measuring face, 2 adjustable square measuring faces

Delivery

- Cardboard box

☒	☒	Max. nominal size mm	Order no.	List price EUR
		0 - 6	0649 201	72.00
		6 - 13	0649 202	72.00
		13 - 19	0649 203	72.00
		19 - 26	0649 204	74.00
		26 - 32	0649 205	74.00
		32 - 38	0649 206	78.00
		38 - 44	0649 207	78.00
		44 - 51	0649 208	81.00
		51 - 57	0649 209	81.00
		57 - 64	0649 210	85.00

☒	☒	Max. nominal size mm	Order no.	List price EUR
		64 - 70	0649 211	85.00
		70 - 78	0649 212	93.00
		78 - 87	0649 213	93.00
		87 - 97	0649 215	103.00
		97 - 106	0649 216	118.00
		106 - 116	0649 217	118.00
		116 - 125	0649 219	141.00
		125 - 135	0649 220	183.00
		135 - 144	0649 222	210.00
		144 - 156	0649 223	210.00



0656 Ring gauges



Model

- DIN 2250-1 (C)
- Hardened gauge steel
- For setting internal measuring instruments

DIN
2250-1

⌕	📏	Nominal size	Order no.	List price	⌕	📏	Nominal size	Order no.	List price
		mm		EUR			mm		EUR
		3.0	0656 309	57.00			58	0656 355	108.00
		3.5	0656 310	50.00			60	0656 356	113.00
		4.0	0656 311	50.00			62	0656 357	116.00
		4.5	0656 312	50.00			65	0656 358	123.00
		5.0	0656 313	49.20			68	0656 359	132.00
		6.0	0656 314	47.90			70	0656 360	137.00
		7.0	0656 315	47.90			72	0656 361	142.00
		8.0	0656 316	47.90			75	0656 362	146.00
		9.0	0656 317	47.90			78	0656 363	154.00
		10.0	0656 318	47.90			80	0656 364	159.00
		11.0	0656 319	49.20			82	0656 365	168.00
		12.0	0656 320	50.00			85	0656 366	179.00
		12.5	0656 303	50.00			88	0656 367	191.00
		13.0	0656 321	51.00			90	0656 368	197.00
		14.0	0656 322	51.00			92	0656 369	205.00
		15.0	0656 323	52.00			95	0656 370	219.00
		16.0	0656 324	52.00			98	0656 371	229.00
		17.0	0656 325	53.00			100	0656 372	237.00
		17.5	0656 304	75.00			105	0656 373	248.00
		18.0	0656 326	53.00			110	0656 374	261.00
		19.0	0656 327	54.00			115	0656 375	272.00
		20	0656 328	56.00			120	0656 376	284.00
		21	0656 329	56.00			125	0656 377	297.00
		22	0656 330	56.00			130	0656 378	307.00
		23	0656 331	59.00			135	0656 379	320.00
		24	0656 332	60.00			140	0656 380	331.00
		25	0656 333	61.00			145	0656 381	343.00
		26	0656 334	63.00			150	0656 382	355.00
		27	0656 335	63.00			155	0656 383	388.00
		28	0656 336	64.00			160	0656 384	419.00
		30	0656 337	59.00			165	0656 385	450.00
		32	0656 338	67.00			170	0656 386	483.00
		33	0656 339	67.00			175	0656 387	516.00
		34	0656 340	68.00			180	0656 388	547.00
		35	0656 341	68.00			185	0656 389	580.00
		36	0656 342	69.00			190	0656 390	611.00
		37	0656 343	71.00			195	0656 391	644.00
		38	0656 344	72.00			200	0656 392	675.00
		40	0656 345	73.00			210	0656 393	712.00
		42	0656 346	77.00			220	0656 394	743.00
		44	0656 347	81.00			225	0656 305	893.00
		45	0656 348	83.00			230	0656 395	778.00
		46	0656 349	85.00			240	0656 396	813.00
		47	0656 350	88.00			250	0656 397	848.00
		48	0656 351	90.00			260	0656 398	883.00
		50	0656 352	93.00			270	0656 399	916.00
		52	0656 353	95.00			275	0656 306	983.00
		55	0656 354	104.00					



0637 Plug gauges



Model

- Manufacturing tolerances: according to DIN 7150-2 and DIN 7164
- Fit H7
- All cylindrical
- Special dimensions with other tolerances are available upon request

✂	📏	Dimensions acc. to Din	Nominal size mm	Order no.	List price EUR
Gauge steel, hardened					
		2245-1	2	0637 103	31.10
		2245-1	2.2	0637 104	31.10
		2245-1	2.5	0637 105	31.10
		2245-1	2.8	0637 106	22.60
		2245-1	3	0637 107	22.60
		2245-1	3.5	0637 108	20.20
		2245-1	4	0637 109	20.20
		2245-1	4.5	0637 110	20.20
		2245-1	5	0637 111	19.10
		2245-1	6	0637 112	19.10
		2245-1	7	0637 113	20.20
		2245-1	8	0637 114	20.20
		2245-1	9	0637 115	21.60
		2245-1	10	0637 116	22.60
		2245-1	11	0637 117	22.60
		2245-1	12	0637 118	24.00
		2245-1	13	0637 119	25.10
		2245-1	14	0637 120	25.10
		2245-1	15	0637 121	25.80
		2245-1	16	0637 122	25.80
		2245-1	17	0637 123	27.00
		2245-1	18	0637 124	28.00
		2245-1	19	0637 125	28.00
		2245-1	20	0637 126	28.00
		2245-1	21	0637 127	29.50
		2245-1	22	0637 128	30.10
		2245-1	23	0637 129	31.10
		2245-1	24	0637 130	31.10
		2245-1	25	0637 131	32.30
		2245-1	26	0637 132	33.60
		2245-1	27	0637 133	33.60
		2245-1	28	0637 134	34.60
		2245-1	30	0637 135	34.60
		2245-1	32	0637 136	38.30

✂	📏	Dimensions acc. to Din	Nominal size mm	Order no.	List price EUR
		2245-1	33	0637 137	39.00
		2245-1	34	0637 138	40.10
		2245-1	35	0637 139	40.10
		2245-1	36	0637 140	41.10
		2245-1	37	0637 141	41.90
		2245-1	38	0637 142	43.10
		2245-1	40	0637 144	44.40
		2245-2	42	0637 146	45.70
		2245-2	43	0637 147	56.00
		2245-2	44	0637 148	49.20
		2245-2	45	0637 149	50.00
		2245-2	46	0637 150	51.00
		2245-2	47	0637 151	53.00
		2245-2	48	0637 152	54.00
		2245-2	50	0637 154	56.00
		2245-2	52	0637 155	59.00
		2245-2	55	0637 156	63.00
		2245-2	58	0637 157	67.00
		2245-2	60	0637 158	69.00
		2245-2	62	0637 159	73.00
		2245-2	65	0637 160	73.00
		2245-2	68	0637 161	80.00
		2245-2	70	0637 162	81.00
		2245-2	72	0637 163	83.00
		2245-2	75	0637 164	88.00
		2245-2	78	0637 165	92.00
		2245-2	80	0637 166	93.00
		2245-2	82	0637 167	95.00
		2245-2	85	0637 168	99.00
		2245-2	88	0637 169	104.00
		2245-2	90	0637 170	105.00
		2245-2	92	0637 171	108.00
		2245-2	95	0637 172	110.00
		2245-2	98	0637 173	114.00
		2245-2	100	0637 174	116.00



0637 Plug gauge set



Model

- DIN 2245
- Hardened gauge steel
- GO and NO GO

Delivery

- Wooden box

DIN 2245

✕	☒	Number of gauges	ISO fit	Nominal size mm	Order no.	List price EUR
		(3, 4, 5, 6, 8, 10, 12)				
		7	H7	3 - 12	0637 190	148.00

PLUG GAUGES WITH SPECIAL DIMENSIONS

FAST DELIVERY

More information and the price list on request or directly online at www.helios-preisser.de/en/downloads



Custom-made according to ISO Fits

or according to your Nominal size & tolerance

DIN 2245-Z / Gauge steel / All cylindrical





0658 Thread plug gauges



**DIN
2280**

Model

- DIN 2280
- For standard metric ISO threads DIN 13
- Gauge steel, hardened

Marked	Marked	ISO Fit	Type of thread	Nominal size	Thread pitch	Order no.	List price
				mm	mm		EUR
		6H	M	3.0	0.50	0658 009	68.00
		6H	M	4.0	0.70	0658 011	64.00
		6H	M	5.0	0.80	0658 012	63.00
		6H	M	6.0	1.00	0658 013	60.00
		6H	M	8.0	1.25	0658 015	63.00
		6H	M	10.0	1.50	0658 017	67.00
		6H	M	12.0	1.75	0658 019	72.00

0658 Set of thread plug gauges



Delivery

- Wooden box

**DIN
2280**

Marked	Marked	Tolerance class	Type of thread	Max. nominal size	Order no.	List price
				mm		EUR
		(M3, M4, M5, M6, M8, M10, M12)				
		6H	M	M3 - M12	0658 090	252.00

0658 GO thread ring gauges



Model

- DIN 2285-1
- GO thread ring gauge
- For standard metric ISO threads DIN 13
- Hardened gauge steel

**DIN
2285-1**

Marked	Marked	ISO Fit	Type of thread	Nominal size	Thread pitch	Order no.	List price
				mm	mm		EUR
		6g	M	3.0	0.50	0658 509	53.00
		6g	M	4.0	0.70	0658 511	49.20
		6g	M	5.0	0.80	0658 512	49.20
		6g	M	6.0	1.00	0658 513	49.20
		6g	M	8.0	1.25	0658 515	50.00
		6g	M	10.0	1.50	0658 517	59.00
		6g	M	12.0	1.75	0658 519	69.00



0658 NO GO thread ring gauges



Model

- DIN 2299-1
- NO GO thread ring gauge
- For standard metric ISO threads DIN 13
- Hardened gauge steel

DIN
2299-1

☒	☒	ISO Fit	Type of thread	Nominal size mm	Thread pitch mm	Order no.	List price EUR
		6g	M	3.0	0.50	0658 609	53.00
		6g	M	4.0	0.70	0658 611	49.20
		6g	M	5.0	0.8	0658 612	49.20
		6g	M	6.0	1.0	0658 613	49.20
		6g	M	8.0	1.25	0658 615	50.00
		6g	M	10.0	1.5	0658 617	59.00
		6g	M	12.0	1.75	0658 619	69.00

0658 Thread ring gauges GO

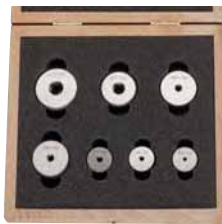

Model

- 7-pieces
- Hardened gauge steel
- For standard metric ISO threads DIN 13
- Fit 6g

Delivery

- Wooden case

DIN
2285-1

☒	☒	ISO Fit	Type of thread	Nominal size mm	Order no.	List price EUR
		(M3, M4, M5, M6, M8, M10, M12)				
		6g	M	3 - 12	0658 590	252.00

0658 Thread ring gauges NO GO

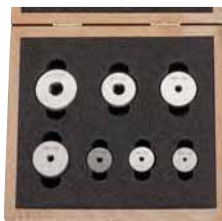

Model

- 7-pieces
- Hardened gauge steel
- For standard metric ISO threads DIN 13

Delivery

- Wooden case

DIN
2299-1

☒	☒	ISO Fit	Type of thread	Nominal size mm	Order no.	List price EUR
		(M3, M4, M5, M6, M8, M10, M12)				
		6g	M	3 - 12	0658 690	252.00



HELIOS · PREISSER

SAMPLES DATA TRANSMISSION



integrated IW wireless

NO CABLE
NO RADIO MODULE

Thanks to the integrated wireless system our measuring devices from series **i** offer simple data transmission without additional cables

Transmission of data directly to MS Excel® or into any application on Windows via keyboard interface

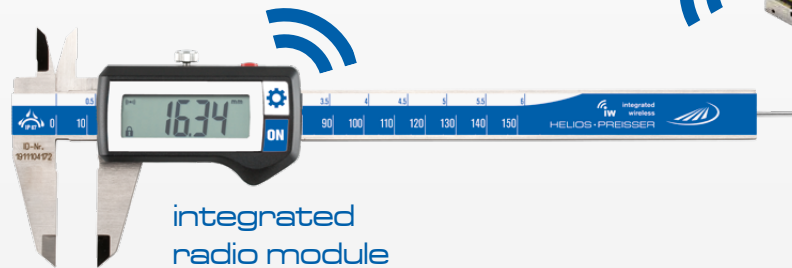

Receiver
i-Stick



1326i

DATA Variable

ONE INTERFACE
MANY OPTIONS

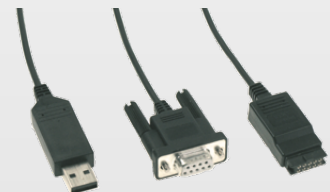

OUT **STANDARD** FOR
DATA TRANSMISSION
WITH CABLES

USB + RS 232 + DIGIMATIC

7. CHAPTER DATA TRANSMISSION

250 Data cables Data Variable / Software

251 Data cables Opto / BlueDat

252 Integrated Wireless



1998 / 1997 Data cable DATA VARIABLE



Our Interface: Data Variable



DATA-Button
To transfer the measured results

Possible connections



USB RS 232 Digimatic

Model

- Available for all DIGI-MET measuring instruments with a variable data output (DATA VARIABLE)
- Length 2 m
- With a data transfer button on the plug-in jack
- For use with MarCom Professional software to transfer the measured results to PC, laptop or workstation

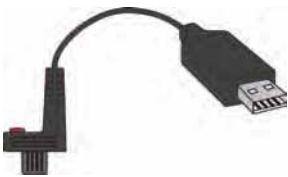

1998 720



1997 501

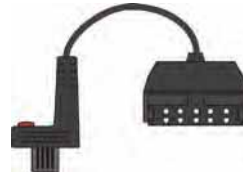

1998 501

	Description	Order no.	List price EUR
	Cable DataVariable for RS 232	1997 501	50.00
	Cable DataVariable for Digimatic	1998 501	64.00
	Cable DataVariable for USB	1998 720	72.00
Bidirectional (for suitable micrometers only)			
	Data cable bidirectional DataVariable to USB	1998 801	98.00
	Data cable bidirectional DataVariable to Digimatic	1998 802	85.00

1998 Software MarCom Professional



Model

Software for easy data acquisition, for all measuring instruments with variable data output (DATA VARIABLE) and integrated wireless (IW)

- Connection to more than 100 measuring instruments with USB data cable possible
- Data transmission with virtual interface box MUX 50 format possible
- Connection of two serial COM-interfaces possible
- Several foot switches via USB connectable, the measuring instruments can be freely assigned
- USB Hubs connectable as measuring instrument interface
- Wireless data transfer with Integrated Wireless (IW) devices
- Wireless data transfer via **blueDAT**

System requirements

IBM AT compatible PC, MS Windows 7 / 8 / 10, USB-interface from version 2.0 MS EXCEL® from version 97



	Description	Order no.
	MarCom Professional	1998 710



1998 Accesories for data aquisition with MarCom

Example: possible measuring station setup

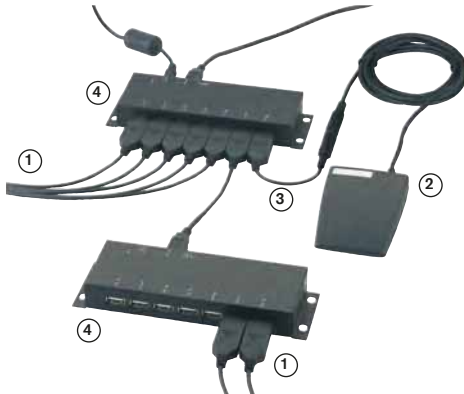

Model

- 1. USB-cable to devices
- 2. Foot switch with jack plug
- 3. USB-adapter-cable for foot switch
- 4. USB-hub for connecting several devices

☒ ☒	Description	Order no.	List price EUR
	Cable DataVariable for USB	1998 720	72.00
	USB-adapter cable for foot switch	1998 722	60.00
	USB-hub sevenfold with plug-in power supply	1998 730	120.00
	Foot-switch* (length of the cable 2 m)	1998 732	72.00

* To connect to the MarCom, the USB-adapter cable Ref. No. 1998 722 is required

0996 Data cable opto



0996 701



0996 705

☒ ☒	Description	Order no.	List price EUR
	Cable Opto for RS232	0996 701	77.00
	Cable Opto for USB	0996 705	147.00

1998 blueDAT - wireless data transmission (bluetooth)



1998 740



1998 742



1998 744



1998 746



1998 748

Model

Available for all DIGI-MET measuring instruments with a variable data output (DATA VARIABLE)

- Reach: approx. 10 m
- With a data transfer button on the plug-in jack
- USB receiver for use with MarCom Professional software to transfer the measured results to PC, laptop or workstation

☒ ☒	Description	Order no.	List price EUR
	blueDAT USB receiver	1998 740	101.00
	blueDAT for DATA Variable	1998 742	363.00
	blueDAT for RS 232 opto	1998 744	363.00
	blueDAT for RS 232 Proximity	1998 746	497.00
	blueDAT for RS 232 Power (Powered through cable)	1998 748	497.00



1998 i-Stick USB-receiver for Integrated Wireless



integrated iW wireless

Wireless Data Transmission



☒	☒	Number of channels	Frequency band	Radio range	Number of i-Sticks per workspace	Number of devices max.	For measuring instruments	Order no.	List price Euro
		3	MHz	up to 6 meters	4	32 (8 per i-Stick)	1326i / 1371i / 1726i / 1734i / 1866i	1998 780	EUR
			2400						95.00



1998 i-Stick USB-receiver for Integrated Wireless



Description

- **Measurement without the nuisance of additional modules:** Unlike conventional wireless solutions, which have a large external transmitter with separate battery, the transmitter in Integrated Wireless is fully integrated.
- **Highly mobile:** Integrated Wireless gives you much more mobility. There is no cable to get in the way, either at the measuring station or when measuring on or at the machine or at large workpieces
- **Easy data transfer:** With Integrated Wireless you can transfer your measured values to the PC simply using the i-Stick. As with a data cable, the measured values are accepted via the MarCom software directly into MS Excel® or via a keyboard code into any Windows application
- **Reliable transfer:** With Integrated Wireless you can be sure that your data will arrive safely. Measuring instruments with Integrated Wireless display messages to confirm whether the transmitted data has been correctly transferred or whether you are within receiving range of the i-Stick receiver
- **Long battery life:** The integrated wireless interface makes the measuring instrument exceptionally energy-efficient. And unlike conventional wireless systems, no additional battery is required
- **Affordable:** With Integrated Wireless you can connect up to 8 measuring instruments per i-Stick receiver. Expensive interface boxes are no longer necessary. With even one connected measuring instrument you get a wireless connection for the price of a cable

7



CALIBRATIONS

Traceable calibration certificates
directly from the **expert**

Certificates are already **included**
for **selected products**

We are certified according to
DIN EN ISO 9001:2015



8. CHAPTER CALIBRATION SERVICE ORDER NUMBER INDEX AND KEYWORD INDEX

256 Calibration service

262 Order number index

276 Keyword index





Free initial calibration available with many of our products



All HELIOS-PREISSER measuring instruments with a  marked in the column (=Calibration), will undergo initial calibration and are supplied with a certificate at no extra charge! No separate order is required for these articles to be pre-calibrated on delivery. For all other gauges and measuring instruments and for subsequent calibration the following calibration services are offered. Testing is carried out in accordance with VDI / VDE / DGQ guidelines 26 ff.

Calibration service





Calipers / Depth gauges / Height gauges analogue or digital (1 graduation)

		Max. measuring range	Order no.	List price
		mm		EUR
		150	4310 110	12.40
		300	4310 115	22.10
		500	4310 120	37.40
		1000	4310 125	79.00
		2000	4310 130	109.00
		3000	4310 135	171.00



Micrometers according to DIN 863-1

		Max. measuring range	Order no.	List price
		mm		EUR
		25	4320 210	21.00
		100	4320 212	28.30
		200	4320 214	30.80
		300	4320 220	34.10
		500	4320 224	45.00
		1000	4320 228	62.00

Micrometers with interchangeable inserts including setting standard

		Max. measuring range	Order no.	List price
		mm		EUR
		100	4320 810	132.00
		200	4320 814	188.00
		300	4320 818	201.00
		400	4320 822	206.00
		500	4320 826	206.00
		600	4320 830	206.00
		700	4320 834	263.00
		800	4320 838	263.00
		900	4320 842	263.00
		1000	4320 846	263.00
		1200	4320 850	312.00
		1400	4320 854	312.00
		1600	4320 858	373.00
		1800	4320 862	373.00
		2000	4320 866	373.00

DAkKS Calibration for Calipers / Depth gauges analogue or digital (1 graduation)

		Max. measuring range	Order no.	List price
		mm		EUR
Pocket and workshop calipers				
		300	4380 110	35.70
		500	4380 112	49.00
		1000	4380 114	88.00
Depth gauges				
		300	4380 120	35.40
		500	4380 122	48.00
		1000	4380 124	88.00
Depth gauges with hook				
		300	4380 130	46.50
		500	4380 132	73.00
		1000	4380 134	89.00



DAkKS Calibration for micrometers according to DIN 863-1 analogue or digital (1 graduation)

		Measuring range	Order no.	List price
		mm		EUR
		0 - 25	4380 140	44.50
		0 - 100	4380 142	48.40

DAkKS Calibration for micrometer setting standards

		Max. measuring range	Order no.	List price
		mm		EUR
		500	4380 149	91.00

Setting standards for micrometers Tolerance zone js2

		Max. measuring range	Order no.	List price
		mm		EUR
		100	4329 010	7.50
		250	4329 026	17.20
		1000	4329 046	34.30



Calibration service



Indicators, analogue and digital readings/resolution 0.01 and 0.001

	Measuring span	Order no.	List price
	mm		EUR
	13	4360 210	26.10
	30	4360 212	37.40
	50	4360 214	42.40
	100	4360 218	55.00

DAkKS Calibration for Indicators, analogue and digital readings/resolution 0.01 and 0.001

	Measuring span	Order no.	List price
	mm		EUR
	Up to 10	4380 150	54.00
	10	4380 151	58.00
	30	4380 152	68.00
	50	4380 154	78.00
	100	4380 156	110.00

Internal micrometers analogue and digital

	Max. measuring range	Order no.	List price
	mm		EUR
	0 - 100	4322 810	46.90
	100 - 200	4322 814	93.00
	200 - 300	4322 818	115.00

DAkKS Calibration for internal micrometers analogue and digital

	Max. measuring range	Order no.	List price
	mm		EUR
	2 - 100	4380 160	70.00

Universal bevel protractor analogue or digital (1 blade)

	Max. measuring range	Order no.	List price
	in °		EUR
	360	4342 610	28.30

DAkKS Calibration for universal bevel protractor analogue or digital (1 blade)

	Max. measuring range	Order no.	List price
	in °		EUR
	360	4380 170	83.00

Protractors

	Order no.	List price
		EUR
	4342 410	12.40



Calibration service



Squares with and without base, knife edge squares according to DIN 875 all accuracies

	Max. length mm	Order no.	List price EUR
	100	4340 210	16.10
	200	4340 214	17.70
	500	4340 218	26.10
	750	4340 222	44.60
	1000	4340 226	54.00
	1500	4340 230	79.00

Graduated Rules according to DIN 866 Type A / B

	Max. length mm	Order no.	List price EUR
	500	4350 210	32.30
	1000	4350 218	53.00
	1500	4350 226	79.00
	2000	4350 232	103.00
	3000	4350 238	144.00

Flat rules according to DIN 874 Part 1 all accuracies

	Max. length mm	Order no.	List price EUR
	500	4351 610	27.00
	1000	4351 618	63.00
	2000	4351 628	94.00
	3000	4351 638	120.00

Knife edge rules according to DIN 874 Part 2 all accuracies

	Max. length mm	Order no.	List price EUR
	200	4352 412	15.30
	500	4352 418	24.40
	1000	4352 422	46.10

Levels

	Max. length mm	Order no.	List price EUR
	300	4353 410	56.00

Frame levels

	Max. length mm	Order no.	List price EUR
	300	4353 510	78.00

Parallel gauge blocks

	Max. nominal size	Order no.	List price EUR
	100	4357 010	11.60
	300	4357 020	34.10

Plug gauges GO / NOGO

	Max. diameter mm	Order no.	List price EUR
	100	4357 610	11.80
	200	4357 620	20.10



Calibration service



Setting rings (master rings)

	Max. diameter mm	Order no.	List price EUR
	100	4358 410	17.70
	200	4358 420	31.20

Dial test indicator

	Order no.	List price EUR
	4360 810	36.20

Snap gauges GO and NOGO

	Max. nominal size	Order no.	List price EUR
	100	4358 810	20.10

Caliper gauges analogue and digital

	Order no.	List price EUR
	4361 410	55,00

Thread plug gauges GO / NOGO

	Max. diameter mm	Order no.	List price EUR
	100	4359 210	25.50

Thread master rings

	Max. diameter mm	Order no.	List price EUR
	100	4359 410	32.70

Order number index



Order no.	Page	List price in €	Order no.	Page	List price in €	Order no.	Page	List price in €
0003217	73	7.70	0197505	13	75.00	0237517	34	1231.00
0003219	73	7.70	0197508	13	149.00	0237518	33	693.00
0003220	73	9.20	0198501	13	30.50	0237519	34	1016.00
0003221	73	11.60	0199501	13	30.50	0237520	34	1269.00
0003222	73	16.00	0203501	14	52.00	0237521	34	1713.00
0003223	73	17.90	0212520	18	133.00	0237524	33	1484.00
0003224	73	27.00	0212522	18	195.00	0237525	34	1792.00
0003225	73	35.10	0212524	18	195.00	0237526	33	2249.00
0003226	73	41.90	0212526	18	219.00	0237527	34	2663.00
0003228	73	46.70	0212528	18	219.00	0238503	36	379.00
0003229	73	47.90	0217501	17	67.00	0238508	36	542.00
0003230	73	49.20	0217502	17	135.00	0238514	36	724.00
0003231	73	50.00	0218501	17	90.00	0238518	36	848.00
0003232	73	50.00	0220204	83	3.30	0238524	36	2199.00
0003233	73	60.00	0220704	20	3.90	0238526	36	2560.00
0003235	73	73.00	0220705	22	22.40	0252201	50	143.00
0003236	73	61.00	0222734	42	2677.00	0252202	50	275.00
0003237	73	66.00	0222736	42	3212.00	0252203	50	301.00
0003238	73	67.00	0223734	42	2856.00	0252291	50	4.40
0003239	73	75.00	0223736	42	3309.00	0252293	50	5.40
0003240	73	86.00	0224734	43	2421.00	0253300	50	84.00
0003241	73	86.00	0224736	43	2934.00	0253301	50	84.00
0003242	73	82.00	0225734	43	2552.00	0253302	50	107.00
0003243	73	88.00	0225736	43	3029.00	0253311	50	109.00
0003244	73	99.00	0228701	46	493.00	0253391	50	3.90
0003245	73	109.00	0228702	46	686.00	0258501	51	144.00
0003246	73	118.00	0228703	46	964.00	0258502	51	192.00
0003247	73	135.00	0228704	46	1137.00	0258503	51	295.00
0003248	73	115.00	0228724	46	2869.00	0258504	51	333.00
0003249	73	115.00	0228726	46	3410.00	0258505	51	372.00
0003251	73	152.00	0230503	35	178.00	0260501	52	74.00
0003252	73	165.00	0230508	35	510.00	0260502	52	74.00
0003253	73	196.00	0231503	35	205.00	0262503	49	271.00
0003254	73	255.00	0231508	35	557.00	0268201	54	308.00
0003255	73	301.00	0234503	32	164.00	0268211	54	376.00
0003256	73	284.00	0234508	32	489.00	0273731	71	205.00
0003257	73	306.00	0234514	32	628.00	0273732	71	212.00
0003258	73	318.00	0234518	32	754.00	0273735	71	229.00
0003259	73	368.00	0234524	32	1585.00	0273738	71	243.00
0003280	190	4.30	0234526	32	2321.00	0273741	71	295.00
0003281	190	4.70	0235503	32	189.00	0273745	71	516.00
0003282	190	4.90	0235508	32	528.00	0273746	71	562.00
0003283	190	6.10	0235514	32	692.00	0273751	71	368.00
0003284	190	6.80	0235518	32	817.00	0273752	71	373.00
0003285	190	7.70	0235524	32	1681.00	0273755	71	396.00
0003286	190	9.00	0235526	32	2476.00	0273758	71	417.00
0003287	190	8.50	0236503	33	146.00	0273761	71	448.00
0003288	190	19.30	0236504	34	258.00	0273765	71	629.00
0003289	190	11.60	0236508	33	407.00	0273766	71	676.00
0003290	190	19.30	0236509	34	536.00	0276711	61	6.40
0003291	190	33.30	0236510	34	640.00	0279722	63	272.00
0003292	190	36.80	0236514	33	504.00	0279723	63	284.00
0003293	190	37.10	0236515	34	779.00	0279724	63	296.00
0003294	190	41.50	0236516	34	994.00	0279792	63	21.50
0180310	16	4.40	0236517	34	1166.00	0281501	55	89.00
0180320	16	7.10	0236518	33	629.00	0281502	55	92.00
0180330	16	7.10	0236519	34	956.00	0281505	55	115.00
0182501	15	34.50	0236520	34	1206.00	0282501	56	78.00
0184501	10	26.00	0236521	34	1647.00	0282502	56	82.00
0184505	10	34.50	0236524	33	1387.00	0282503	56	93.00
0184508	10	51.00	0236525	34	1692.00	0282505	56	99.00
0185500	10	20.00	0236526	33	2090.00	0282507	56	152.00
0185501	10	26.00	0236527	34	2506.00	0282508	56	232.00
0185505	10	34.50	0237503	33	174.00	0282509	56	387.00
0185508	10	51.00	0237504	34	283.00	0282510	56	548.00
0188501	11	23.00	0237508	33	457.00	0286501	57	93.00
0189501	11	23.00	0237509	34	586.00	0286502	57	94.00
0190501	14	27.00	0237510	34	691.00	0286505	57	115.00
0194501	11	27.00	0237514	33	567.00	0286507	57	184.00
0195501	11	27.00	0237515	34	843.00	0286508	57	388.00
0197501	13	33.00	0237516	34	1055.00	0286509	57	523.00



Order no.	Page	List price in €	Order no.	Page	List price in €	Order no.	Page	List price in €
0286510	57	666.00	0311107	165	8.50	0368210	176	602.00
0292501	58	88.00	0311108	165	9.10	0368211	176	1034.00
0292502	58	100.00	0311120	165	2.30	0368212	176	2193.00
0294505	58	750.00	0311121	165	19.10	0369102	176	17.50
0294507	58	1581.00	0312101	166	3.40	0369103	176	18.90
0300007	162	2.10	0312103	166	4.90	0369104	176	23.10
0300008	162	2.30	0312105	166	5.90	0369105	176	32.00
0300009	162	1.10	0312107	166	7.30	0369106	176	43.30
0300010	162	1.10	0312108	166	8.80	0369107	176	60.00
0300011	162	2.10	0313101	166	3.40	0369108	176	121.00
0300102	162	5.60	0313103	166	4.90	0369109	176	158.00
0300112	162	4.70	0313105	166	5.90	0369110	176	253.00
0300114	162	8.80	0313107	166	7.30	0369111	176	470.00
0300120	162	12.80	0313108	166	8.80	0369112	176	838.00
0300130	162	3.40	0321301	169	22.70	0369202	176	32.40
0301001	163	7.30	0321302	169	25.40	0369203	176	39.30
0301002	163	8.30	0321303	169	25.90	0369204	176	48.00
0301003	163	9.20	0321305	169	49.30	0369205	176	74.00
0301004	163	12.80	0322501	167	25.90	0369206	176	97.00
0301005	163	15.50	0322503	167	40.60	0369207	176	119.00
0301006	163	41.90	0322510	167	4.60	0369208	176	202.00
0301007	163	59.00	0323308	169	16.90	0369209	176	282.00
0301008	163	78.00	0323318	169	21.60	0369210	176	473.00
0301009	163	109.00	0334101	173	75.00	0369211	176	882.00
0301010	163	160.00	0334102	173	124.00	0369212	176	1655.00
0302001	163	10.70	0343501	168	266.00	0370102	178	15.60
0302002	163	11.80	0343503	168	299.00	0370103	178	17.50
0302003	163	12.60	0344501	168	130.00	0370104	178	23.50
0302004	163	16.50	0344502	168	166.00	0370105	178	29.90
0302005	163	21.60	0344503	168	210.00	0370106	178	40.00
0302006	163	60.00	0344505	168	446.00	0370107	178	49.80
0302007	163	74.00	0345522	170	389.00	0370108	178	99.00
0302008	163	95.00	0345530	170	487.00	0370109	178	145.00
0302009	163	132.00	0345534	170	670.00	0370110	178	205.00
0302010	163	183.00	0345722	171	562.00	0370111	178	410.00
0303001	164	7.10	0345730	171	702.00	0370112	178	690.00
0303002	164	7.70	0345734	171	973.00	0370202	178	17.20
0303003	164	8.80	0345910	170	124.00	0370203	178	19.20
0303004	164	9.40	0345912	170	138.00	0370204	178	29.00
0303005	164	10.70	0347522	170	497.00	0370205	178	38.00
0303006	164	13.10	0347530	170	627.00	0370206	178	52.00
0303007	164	16.30	0347534	170	865.00	0370207	178	69.00
0303008	164	24.60	0347722	171	692.00	0370208	178	175.00
0303009	164	35.40	0347730	171	865.00	0370209	178	225.00
0303010	164	65.00	0347734	171	1190.00	0370210	178	350.00
0304001	164	7.10	0349722	172	594.00	0370211	178	542.00
0304002	164	7.70	0349730	172	756.00	0370212	178	876.00
0304003	164	8.80	0349734	172	1027.00	0371102	178	11.10
0304004	164	9.40	0349910	173	114.00	0371103	178	12.30
0304005	164	10.70	0349912	173	133.00	0371104	178	15.00
0304006	164	13.10	0349914	173	148.00	0371105	178	19.40
0304007	164	16.30	0349916	173	169.00	0371106	178	27.00
0304008	164	24.60	0368102	176	25.20	0371107	178	34.50
0304009	164	35.40	0368103	176	28.20	0371108	178	82.00
0304010	164	65.00	0368104	176	37.80	0371109	178	107.00
0306001	163	13.70	0368105	176	48.10	0371110	178	149.00
0306003	163	15.50	0368106	176	64.00	0371111	178	280.00
0306005	163	24.20	0368107	176	79.00	0371112	178	480.00
0308201	167	94.00	0368108	176	173.00	0371202	178	12.20
0308202	167	113.00	0368109	176	254.00	0371203	178	13.50
0308303	167	138.00	0368110	176	359.00	0371204	178	16.50
0308305	167	163.00	0368111	176	718.00	0371205	178	24.70
0310102	165	4.00	0368112	176	1208.00	0371206	178	33.50
0310103	165	4.40	0368202	176	48.00	0371207	178	42.00
0310105	165	4.90	0368203	176	57.00	0371208	178	138.00
0310107	165	6.30	0368204	176	78.00	0371209	178	175.00
0310108	165	7.40	0368205	176	105.00	0371210	178	269.00
0311101	165	4.30	0368206	176	147.00	0371211	178	493.00
0311102	165	5.00	0368207	176	189.00	0371212	178	795.00
0311103	165	5.90	0368208	176	293.00	0372102	179	12.50
0311105	165	7.00	0368209	176	405.00	0372103	179	14.00

Order number index



Order no.	Page	List price in €	Order no.	Page	List price in €	Order no.	Page	List price in €
0372104	179	18.80	0385202	177	35.10	0395128	187	29.80
0372105	179	23.90	0385203	177	39.00	0395132	186	8.60
0372106	179	32.00	0385204	177	48.20	0395133	186	11.00
0372107	179	39.80	0385205	177	64.00	0395134	186	13.30
0372108	179	59.00	0385206	177	82.00	0395136	186	8.60
0372109	179	72.00	0385208	177	121.00	0395137	186	11.00
0372110	179	95.00	0386102	177	19.10	0395138	186	13.30
0372111	179	120.00	0386103	177	20.50	0395142	186	19.10
0372112	179	175.00	0386104	177	25.10	0395143	186	21.60
0372113	179	769.00	0386105	177	31.10	0395144	186	28.20
0372114	179	950.00	0386106	177	40.10	0395146	186	14.10
0373102	179	8.90	0386108	177	77.00	0395147	186	19.10
0373103	179	9.80	0386202	177	24.20	0395148	186	25.80
0373104	179	12.00	0386203	177	27.40	0396290	188	96.00
0373105	179	15.50	0386204	177	32.30	0396414	185	16.50
0373106	179	19.90	0386205	177	41.90	0396416	185	19.50
0373107	179	26.80	0386206	177	54.00	0396418	185	23.00
0373108	179	42.50	0386208	177	107.00	0396420	185	29.00
0373109	179	59.00	0387200	184	17.90	0396426	185	35.00
0373110	179	76.00	0387201	184	17.90	0396432	189	9.80
0373111	179	94.00	0388102	183	20.20	0396433	189	12.10
0373112	179	145.00	0388103	183	24.00	0396434	189	14.80
0373113	179	699.00	0388104	183	28.70	0396435	189	19.00
0373114	179	840.00	0388105	183	38.60	0396436	189	21.20
0374404	180	10.50	0388106	183	54.00	0396443	188	10.50
0374408	180	11.80	0388108	183	94.00	0396444	188	12.40
0374410	180	14.20	0388202	183	24.00	0396445	188	13.40
0374412	180	17.20	0388203	183	28.20	0396446	188	17.30
0374414	180	21.00	0388204	183	34.00	0396453	188	13.20
0374416	180	26.50	0388205	183	43.90	0396454	188	14.90
0374418	180	35.20	0388206	183	65.00	0396455	188	16.60
0374420	180	47.20	0388208	183	142.00	0396456	188	20.30
0374424	180	56.00	0388210	183	676.00	0396982	189	11.90
0374428	180	85.00	0390102	182	36.20	0396983	189	14.10
0374430	180	199.00	0390103	182	36.20	0396984	189	16.80
0374432	180	292.00	0390104	182	41.90	0397101	184	184.00
0375404	180	7.70	0390105	182	53.00	0411101	191	22.60
0375408	180	8.10	0390106	182	72.00	0411102	191	28.20
0375410	180	8.60	0390108	182	121.00	0411103	191	35.40
0375412	180	10.50	0390202	182	47.90	0411104	191	46.90
0375414	180	11.50	0390203	182	54.00	0411105	191	71.00
0375416	180	15.80	0390204	182	69.00	0411106	191	82.00
0375418	180	17.50	0390205	182	89.00	0411107	191	108.00
0375420	180	21.50	0390206	182	111.00	0411108	191	140.00
0375424	180	25.50	0390208	182	171.00	0411109	191	148.00
0375428	180	33.00	0391102	182	56.00	0411110	191	154.00
0375430	180	96.00	0391103	182	56.00	0411301	191	25.10
0375432	180	145.00	0391104	182	73.00	0411302	191	32.30
0376102	181	12.30	0391105	182	92.00	0411303	191	35.90
0376103	181	13.10	0391106	182	124.00	0411304	191	52.00
0376104	181	16.50	0391108	182	181.00	0411305	191	103.00
0376105	181	27.10	0391202	182	67.00	0411306	191	130.00
0376112	181	11.50	0391203	182	75.00	0411307	191	141.00
0376113	181	12.20	0391204	182	85.00	0411308	191	147.00
0376114	181	14.80	0391205	182	109.00	0411309	191	155.00
0376115	181	20.70	0391206	182	140.00	0411310	191	191.00
0376116	181	25.60	0391208	182	227.00	0412201	191	35.40
0376117	181	30.50	0394101	183	212.00	0412202	191	38.30
0380103	185	57.00	0394104	183	38.30	0412203	191	39.40
0380104	185	68.00	0394110	183	85.00	0412204	191	55.00
0380105	185	85.00	0395102	187	28.00	0413301	192	23.90
0380106	185	94.00	0395103	187	31.10	0413302	192	24.90
0380107	185	102.00	0395104	187	41.90	0415301	192	65.00
0380108	185	262.00	0395106	187	19.70	0415302	192	101.00
0380109	185	466.00	0395107	187	21.60	0415303	192	137.00
0385102	177	25.30	0395108	187	31.10	0415304	192	188.00
0385103	177	27.00	0395122	187	26.50	0415305	192	213.00
0385104	177	32.30	0395123	187	30.30	0416301	193	130.00
0385105	177	48.20	0395124	187	40.60	0416302	193	170.00
0385106	177	67.00	0395126	187	19.00	0416303	193	220.00
0385108	177	117.00	0395127	187	21.20	0416304	193	364.00

Order number index



Order no.	Page	List price in €	Order no.	Page	List price in €	Order no.	Page	List price in €
0416305	193	422.00	0458206	201	168.00	0464207	204	2534.00
0420121	195	16.30	0460201	198	1.10	0464208	204	4520.00
0420201	195	56.00	0460202	198	1.10	0465101	203	32.30
0420202	195	60.00	0460204	198	1.60	0465102	203	53.00
0420203	195	65.00	0460205	198	4.30	0465103	203	72.00
0420206	195	18.40	0460206	198	9.20	0465104	203	132.00
0420207	195	19.30	0460207	198	3.20	0465105	203	268.00
0420208	195	19.50	0460208	198	7.70	0465106	203	502.00
0422590	193	19.50	0460209	198	16.00	0465107	203	862.00
0425701	194	1318.00	0460210	198	25.80	0465108	203	1393.00
0425702	194	1331.00	0460211	198	31.10	0465201	204	59.00
0425703	194	1342.00	0460212	198	72.00	0465202	204	91.00
0451101	200	25.80	0460213	198	111.00	0465203	204	164.00
0451102	200	59.00	0460221	198	1.10	0465204	204	256.00
0451103	200	106.00	0460222	198	1.10	0465205	204	604.00
0451104	200	147.00	0460223	198	1.60	0465206	204	920.00
0451105	200	304.00	0460224	198	1.60	0465207	204	1772.00
0451106	200	552.00	0460225	198	4.30	0465208	204	2610.00
0451201	200	45.70	0460226	198	9.20	0466101	203	22.20
0451202	200	105.00	0460227	198	3.20	0466102	203	39.00
0451203	200	156.00	0460228	198	7.70	0466103	203	44.40
0451204	200	274.00	0460229	198	16.00	0466104	203	85.00
0451205	200	552.00	0460230	198	25.80	0466105	203	116.00
0451206	200	998.00	0460231	198	31.10	0466106	203	256.00
0452101	200	20.30	0460232	198	72.00	0466107	203	400.00
0452103	200	40.10	0460233	198	111.00	0466108	203	951.00
0452104	200	58.00	0460241	198	1.10	0466201	204	38.30
0452105	200	95.00	0460242	198	1.10	0466202	204	67.00
0452106	200	150.00	0460243	198	1.60	0466203	204	98.00
0452107	200	166.00	0460244	198	1.60	0466204	204	204.00
0452108	200	317.00	0460245	198	4.30	0466205	204	344.00
0452109	200	570.00	0460246	198	9.20	0466206	204	572.00
0452201	200	27.10	0460247	198	3.20	0466207	204	817.00
0452203	200	59.00	0460248	198	7.70	0466208	204	1521.00
0452204	200	101.00	0460249	198	16.00	0478012	206	172.00
0452205	200	160.00	0460250	198	25.80	0478015	206	301.00
0452206	200	306.00	0460251	198	31.10	0478016	206	379.00
0452207	200	318.00	0460252	198	72.00	0478017	206	491.00
0452208	200	572.00	0460253	198	111.00	0478112	206	135.00
0452209	200	1090.00	0460501	199	2.70	0478115	206	223.00
0453422	199	8.90	0460502	199	4.30	0478116	206	301.00
0453430	199	13.20	0460504	199	4.90	0478117	206	379.00
0453434	199	19.50	0460505	199	10.70	0478118	206	423.00
0454424	202	9.40	0460506	199	21.80	0478119	206	546.00
0454428	202	11.70	0460507	199	5.60	0478121	206	602.00
0454434	202	23.20	0460508	199	11.80	0478124	206	1002.00
0454438	202	42.20	0460509	199	24.60	0478127	206	1782.00
0454440	202	64.00	0460510	199	72.00	0478312	206	101.00
0454444	202	169.00	0460511	199	113.00	0478315	206	162.00
0455424	202	17.30	0460521	199	2.70	0478316	206	195.00
0455428	202	21.60	0460522	199	4.30	0478317	206	233.00
0455434	202	41.00	0460524	199	4.90	0478318	206	301.00
0455438	202	73.00	0460525	199	10.70	0478319	206	446.00
0455440	202	107.00	0460526	199	21.80	0478321	206	491.00
0455444	202	226.00	0460527	199	5.60	0478324	206	701.00
0458102	201	38.30	0460528	199	11.80	0478327	206	1114.00
0458103	201	45.70	0460529	199	24.60	0478907	207	324.00
0458104	201	59.00	0464101	203	66.00	0478908	207	324.00
0458105	201	71.00	0464102	203	94.00	0478909	207	347.00
0458106	201	85.00	0464103	203	147.00	0478911	207	365.00
0458107	201	98.00	0464104	203	248.00	0478914	207	412.00
0458108	201	242.00	0464105	203	445.00	0478917	207	495.00
0458109	201	259.00	0464106	203	756.00	0482101	207	488.00
0458110	201	333.00	0464107	203	1161.00	0504012	208	93.00
0458111	201	511.00	0464108	203	1995.00	0504013	208	145.00
0458112	201	521.00	0464201	204	104.00	0504014	208	223.00
0458113	201	531.00	0464202	204	142.00	0504112	208	66.00
0458202	201	68.00	0464203	204	268.00	0504113	208	88.00
0458203	201	86.00	0464204	204	445.00	0504114	208	145.00
0458204	201	105.00	0464205	204	823.00	0504312	208	45.50
0458205	201	139.00	0464206	204	1433.00	0504313	208	67.00

Order number index



Order no.	Page	List price in €	Order no.	Page	List price in €	Order no.	Page	List price in €
0504314	208	110.00	0527156	213	355.00	0604004	225	7.50
0508011	209	307.00	0536201	214	391.00	0604006	225	7.50
0508012	209	370.00	0536202	214	438.00	0604202	225	9.00
0508013	209	542.00	0536211	214	546.00	0604204	225	11.10
0508111	209	266.00	0536212	214	645.00	0604206	225	11.10
0508112	209	328.00	0536213	214	650.00	0605101	226	2.50
0508113	209	500.00	0536220	214	103.00	0605102	226	2.30
0512101	205	10.50	0536230	214	141.00	0605103	226	2.30
0512102	205	11.80	0550021	215	282.00	0605104	226	2.30
0512103	205	13.30	0550022	215	309.00	0605105	226	3.40
0512104	205	15.10	0550023	215	337.00	0605106	226	3.60
0512105	205	19.70	0550024	215	365.00	0605107	226	5.10
0512106	205	37.10	0550101	215	199.00	0605108	226	3.00
0512107	205	66.00	0550102	215	227.00	0605109	226	3.20
0512108	205	104.00	0550103	215	255.00	0605110	226	3.00
0512201	205	13.70	0550104	215	282.00	0605111	226	3.00
0512202	205	16.00	0550131	215	155.00	0605112	226	3.40
0512203	205	16.70	0550132	215	182.00	0606121	226	1.60
0512204	205	18.70	0550133	215	209.00	0606123	226	1.60
0512205	205	21.60	0550134	215	237.00	0606127	226	1.60
0512206	205	46.90	0556022	215	542.00	0606130	226	2.50
0512207	205	85.00	0556023	215	619.00	0606132	226	3.00
0512208	205	116.00	0556024	215	872.00	0606133	226	5.60
0512209	205	224.00	0556101	215	332.00	0606136	226	5.10
0512210	205	454.00	0556102	215	387.00	0606150	227	3.40
0512211	205	595.00	0556103	215	485.00	0606152	227	4.10
0512601	205	5.40	0556104	215	773.00	0606154	227	5.90
0512602	205	5.40	0563001	216	417.00	0606160	227	8.90
0512603	205	5.40	0580101	216	7.40	0606162	227	10.20
0512604	205	6.50	0580111	216	10.70	0606170	227	10.70
0512605	205	7.60	0580121	217	7.50	0606172	227	13.50
0512606	205	8.60	0580151	217	3.10	0606176	227	17.90
0512607	205	10.80	0581101	218	21.60	0606178	227	26.20
0512608	205	16.30	0581103	218	14.60	0607201	226	3.90
0512609	205	16.30	0581105	218	20.00	0607202	226	6.10
0512610	205	32.50	0581123	218	10.50	0607203	226	8.80
0512611	205	37.90	0581125	218	9.20	0607401	226	6.60
0520101	208	133.00	0582110	219	66.00	0607402	226	8.10
0520102	208	175.00	0582120	219	66.00	0607403	226	11.60
0520103	208	232.00	0582130	219	66.00	0608140	227	1.90
0520104	208	324.00	0584101	232	317.00	0608143	227	4.60
0520105	208	443.00	0589101	220	16.90	0608144	227	7.20
0522101	210	204.00	0589103	220	52.00	0608149	227	16.60
0522102	210	249.00	0590101	220	1.80	0609190	232	82.00
0522103	210	359.00	0590151	221	3.40	0611180	229	231.00
0522111	211	32.00	0595101	222	21.20	0611190	229	251.00
0522112	211	37.00	0595110	221	13.20	0611195	228	3.00
0522113	211	45.00	0595115	222	3.80	0611197	228	39.00
0522201	210	133.00	0595130	217	3.10	0611198	228	59.00
0522202	210	162.00	0595140	217	2.70	0611300	229	79.00
0522203	210	233.00	0595142	217	2.70	0611501	229	45.00
0522206	210	253.00	0595251	222	91.00	0611502	229	34.50
0522207	210	308.00	0597301	53	175.00	0611503	229	13.00
0522208	210	443.00	0597305	53	175.00	0611504	229	13.00
0524101	211	225.00	0598103	224	48.80	0611505	229	11.00
0524102	211	278.00	0598105	224	48.80	0611506	229	9.50
0524103	211	418.00	0598601	224	48.80	0611507	229	9.50
0525101	213	120.00	0599102	224	59.00	0611508	229	9.50
0525102	213	128.00	0599151	224	7.10	0611509	229	9.50
0525103	213	137.00	0599152	224	7.10	0611510	229	9.50
0527101	212	340.00	0600101	223	25.80	0611512	229	9.50
0527102	212	471.00	0600102	223	32.30	0611515	229	9.50
0527104	212	668.00	0600103	223	34.60	0611518	229	9.50
0527105	212	934.00	0600111	223	55.00	0611520	229	9.50
0527106	212	275.00	0600112	223	73.00	0611525	229	9.50
0527107	212	403.00	0600113	223	152.00	0611530	229	9.50
0527108	212	562.00	0600114	223	237.00	0611535	229	11.00
0527109	212	550.00	0600115	223	380.00	0611540	229	11.00
0527110	212	858.00	0601103	225	91.00	0611545	229	11.00
0527111	212	1111.00	0601120	225	69.00	0611550	229	11.00
0527151	213	180.00	0604002	225	6.80	0611552	229	16.50

Order number index



Order no.	Page	List price in €	Order no.	Page	List price in €	Order no.	Page	List price in €
0611554	229	16.50	0613318	231	56.00	0623100	233	42.20
0611556	229	16.50	0613330	231	53.00	0623102	233	35.70
0611558	229	16.50	0613334	231	53.00	0623170	233	35.70
0611560	229	16.50	0613338	231	68.00	0623220	233	35.70
0611562	229	16.50	0613342	231	68.00	0623270	233	35.70
0611564	229	16.50	0613346	231	77.00	0623320	233	35.70
0611566	229	17.50	0613350	231	88.00	0623370	233	35.70
0611568	229	17.50	0613352	231	105.00	0623375	233	35.70
0611570	229	17.50	0613354	231	105.00	0623380	233	35.70
0612180	228	252.00	0613356	231	126.00	0623385	233	35.70
0612501	228	45.00	0613358	231	126.00	0623390	233	35.70
0612502	228	34.50	0613360	231	144.00	0623395	233	35.70
0612503	228	15.00	0613412	231	107.00	0623400	233	37.90
0612504	228	15.00	0613418	231	86.00	0623405	233	37.90
0612505	228	13.00	0613424	231	86.00	0623410	233	37.90
0612506	228	11.00	0613430	231	82.00	0623415	233	37.90
0612507	228	11.00	0613434	231	82.00	0623420	233	37.90
0612508	228	11.00	0613438	231	103.00	0623425	233	37.90
0612509	228	11.00	0613440	231	103.00	0623430	233	37.90
0612510	228	11.00	0613442	231	103.00	0623435	233	37.90
0612512	228	11.00	0613446	231	114.00	0623440	233	37.90
0612515	228	11.00	0613450	231	133.00	0623445	233	37.90
0612518	228	11.00	0613607	230	68.00	0623450	233	37.90
0612520	228	11.00	0613609	230	36.70	0623455	233	37.90
0612525	228	11.00	0613614	230	25.80	0623460	233	37.90
0613107	231	68.00	0613616	230	25.80	0623465	233	37.90
0613109	231	36.70	0613618	230	25.80	0623470	233	37.90
0613114	231	25.80	0613620	230	17.60	0623475	233	45.40
0613116	231	25.80	0613622	230	17.60	0623500	233	45.40
0613118	231	25.80	0613626	230	17.60	0623510	233	45.40
0613120	231	17.60	0613628	230	17.60	0623520	233	45.40
0613122	231	17.60	0613630	230	18.20	0623530	233	45.40
0613126	231	17.60	0613632	230	18.20	0623540	233	45.40
0613128	231	17.60	0613634	230	18.20	0623550	233	45.40
0613130	231	18.20	0613636	230	18.20	0623560	233	45.40
0613134	231	18.20	0613638	230	18.20	0623570	233	45.40
0613138	231	18.20	0613640	230	18.20	0623580	233	45.40
0613142	231	18.20	0613642	230	18.20	0623590	233	45.40
0613146	231	20.20	0613644	230	20.20	0623600	233	45.40
0613150	231	20.20	0613646	230	20.20	0623610	233	45.40
0613152	231	32.30	0613648	230	20.20	0623620	233	45.40
0613154	231	32.30	0613650	230	20.20	0623630	233	45.40
0613156	231	32.30	0613652	230	32.30	0623640	233	45.40
0613158	231	32.30	0613654	230	32.30	0623650	233	54.00
0613160	231	32.30	0613656	230	32.30	0623670	233	54.00
0613207	231	98.00	0613658	230	32.30	0623680	233	54.00
0613209	231	53.00	0613660	230	32.30	0623690	233	54.00
0613214	231	37.10	0613709	230	51.00	0623700	233	54.00
0613216	231	37.10	0613718	230	30.60	0623710	233	67.00
0613218	231	37.10	0613730	230	28.70	0623720	233	67.00
0613220	231	25.30	0613734	230	28.70	0623730	233	80.00
0613222	231	25.30	0613738	230	36.20	0623740	233	283.00
0613226	231	25.30	0613742	230	36.20	0623750	233	283.00
0613228	231	25.30	0613746	230	40.80	0623760	233	283.00
0613230	231	26.30	0613750	230	46.70	0623770	233	338.00
0613232	231	26.30	0613752	230	56.00	0623780	233	482.00
0613234	231	26.30	0613754	230	56.00	0623790	233	626.00
0613236	231	26.30	0613756	230	68.00	0623800	233	866.00
0613238	231	26.30	0613758	230	68.00	0624100	234	28.10
0613240	231	26.30	0613760	230	75.00	0624102	234	23.90
0613242	231	26.30	0613812	230	56.00	0624104	234	23.90
0613244	231	28.70	0613818	230	45.50	0624106	234	23.90
0613246	231	28.70	0613824	230	45.50	0624108	234	23.90
0613248	231	28.70	0613830	230	43.10	0624110	234	23.90
0613250	231	28.70	0613834	230	43.10	0624112	234	23.90
0613252	231	46.70	0613838	230	54.00	0624114	234	23.90
0613254	231	46.70	0613840	230	54.00	0624116	234	23.90
0613256	231	46.70	0613842	230	54.00	0624118	234	23.90
0613258	231	46.70	0613846	230	63.00	0624120	234	23.90
0613260	231	46.70	0613850	230	73.00	0624122	234	23.90
0613309	231	94.00	0613860	230	118.00	0624130	234	23.90

Order number index



Order no.	Page	List price in €	Order no.	Page	List price in €	Order no.	Page	List price in €
0624135	234	23.90	0624520	234	30.30	0625280	235	19.50
0624140	234	23.90	0624530	234	30.30	0625285	235	19.50
0624145	234	23.90	0624540	234	30.30	0625290	235	19.50
0624150	234	23.90	0624550	234	30.30	0625295	235	19.50
0624155	234	23.90	0624560	234	30.30	0625300	235	19.50
0624160	234	23.90	0624570	234	30.30	0625305	235	19.50
0624165	234	23.90	0624580	234	30.30	0625310	235	19.50
0624170	234	23.90	0624590	234	30.30	0625315	235	19.50
0624175	234	23.90	0624600	234	30.30	0625320	235	19.50
0624180	234	23.90	0624610	234	30.30	0625325	235	19.50
0624185	234	23.90	0624620	234	30.30	0625330	235	19.50
0624190	234	23.90	0624630	234	30.30	0625335	235	19.50
0624195	234	23.90	0624640	234	30.30	0625340	235	19.50
0624200	234	23.90	0624650	234	35.70	0625345	235	19.50
0624205	234	23.90	0624660	234	35.70	0625350	235	19.50
0624210	234	23.90	0624670	234	35.70	0625355	235	19.50
0624215	234	23.90	0624680	234	35.70	0625360	235	19.50
0624220	234	23.90	0624690	234	35.70	0625365	235	19.50
0624225	234	23.90	0624700	234	35.70	0625370	235	19.50
0624230	234	23.90	0624710	234	44.40	0625375	235	19.50
0624235	234	23.90	0624720	234	44.40	0625380	235	19.50
0624240	234	23.90	0624730	234	53.00	0625385	235	19.50
0624245	234	23.90	0624740	234	172.00	0625390	235	19.50
0624250	234	23.90	0624750	234	172.00	0625395	235	19.50
0624255	234	23.90	0624760	234	172.00	0625400	235	19.50
0624260	234	23.90	0624770	234	204.00	0625405	235	19.50
0624265	234	23.90	0624780	234	293.00	0625410	235	19.50
0624270	234	23.90	0624790	234	379.00	0625415	235	19.50
0624275	234	23.90	0624800	234	525.00	0625420	235	19.50
0624280	234	23.90	0625100	235	22.70	0625425	235	19.50
0624285	234	23.90	0625102	235	19.50	0625430	235	19.50
0624290	234	23.90	0625104	235	19.50	0625435	235	19.50
0624295	234	23.90	0625106	235	19.50	0625440	235	19.50
0624300	234	23.90	0625108	235	19.50	0625445	235	19.50
0624305	234	23.90	0625110	235	19.50	0625450	235	19.50
0624310	234	23.90	0625112	235	19.50	0625455	235	19.50
0624315	234	23.90	0625114	235	19.50	0625460	235	19.50
0624320	234	23.90	0625116	235	19.50	0625465	235	19.50
0624325	234	23.90	0625118	235	19.50	0625470	235	19.50
0624330	234	23.90	0625120	235	19.50	0625475	235	23.90
0624335	234	23.90	0625122	235	19.50	0625500	235	23.90
0624340	234	23.90	0625130	235	19.50	0625510	235	23.90
0624345	234	23.90	0625135	235	19.50	0625520	235	23.90
0624350	234	23.90	0625140	235	19.50	0625530	235	23.90
0624355	234	23.90	0625145	235	19.50	0625540	235	23.90
0624360	234	23.90	0625150	235	19.50	0625550	235	23.90
0624365	234	23.90	0625155	235	19.50	0625560	235	23.90
0624370	234	23.90	0625160	235	19.50	0625570	235	23.90
0624375	234	23.90	0625165	235	19.50	0625580	235	23.90
0624380	234	23.90	0625170	235	19.50	0625590	235	23.90
0624385	234	23.90	0625175	235	19.50	0625600	235	23.90
0624390	234	23.90	0625180	235	19.50	0625610	235	23.90
0624395	234	23.90	0625185	235	19.50	0625620	235	23.90
0624400	234	24.90	0625190	235	19.50	0625630	235	23.90
0624405	234	24.90	0625195	235	19.50	0625640	235	23.90
0624410	234	24.90	0625200	235	19.50	0625650	235	28.10
0624415	234	24.90	0625205	235	19.50	0625660	235	28.10
0624420	234	24.90	0625210	235	19.50	0625670	235	28.10
0624425	234	24.90	0625215	235	19.50	0625680	235	28.10
0624430	234	24.90	0625220	235	19.50	0625690	235	28.10
0624435	234	24.90	0625225	235	19.50	0625700	235	28.10
0624440	234	24.90	0625230	235	19.50	0625710	235	35.70
0624445	234	24.90	0625235	235	19.50	0625720	235	35.70
0624450	234	24.90	0625240	235	19.50	0625730	235	42.20
0624455	234	24.90	0625245	235	19.50	0625740	235	138.00
0624460	234	24.90	0625250	235	19.50	0625750	235	138.00
0624465	234	24.90	0625255	235	19.50	0625760	235	138.00
0624470	234	24.90	0625260	235	19.50	0625770	235	147.00
0624475	234	30.30	0625265	235	19.50	0625780	235	232.00
0624500	234	30.30	0625270	235	19.50	0625790	235	273.00
0624510	234	30.30	0625275	235	19.50	0625800	235	357.00

Order number index



Order no.	Page	List price in €	Order no.	Page	List price in €	Order no.	Page	List price in €
0633001	237	314.00	0636392	240	13.20	0637172	244	110.00
0633014	238	889.00	0636393	240	15.10	0637173	244	114.00
0633016	238	812.00	0636394	240	28.70	0637174	244	116.00
0633018	238	528.00	0636395	240	36.80	0637190	245	148.00
0633020	238	386.00	0636396	240	42.40	0649201	242	72.00
0633114	238	684.00	0637103	244	31.10	0649202	242	72.00
0633116	238	521.00	0637104	244	31.10	0649203	242	72.00
0633118	238	322.00	0637105	244	31.10	0649204	242	74.00
0633120	238	234.00	0637106	244	22.60	0649205	242	74.00
0633136	236	182.00	0637107	244	22.60	0649206	242	78.00
0633137	236	208.00	0637108	244	20.20	0649207	242	78.00
0633138	236	250.00	0637109	244	20.20	0649208	242	81.00
0633139	236	229.00	0637110	244	20.20	0649209	242	81.00
0633140	236	271.00	0637111	244	19.10	0649210	242	85.00
0633141	236	313.00	0637112	244	19.10	0649211	242	85.00
0633142	236	354.00	0637113	244	20.20	0649212	242	93.00
0633143	236	386.00	0637114	244	20.20	0649213	242	93.00
0633144	236	448.00	0637115	244	21.60	0649215	242	103.00
0633145	236	625.00	0637116	244	22.60	0649216	242	118.00
0633150	236	214.00	0637117	244	22.60	0649217	242	118.00
0633151	236	214.00	0637118	244	24.00	0649219	242	141.00
0633152	236	229.00	0637119	244	25.10	0649220	242	183.00
0633153	236	281.00	0637120	244	25.10	0649222	242	210.00
0633154	236	396.00	0637121	244	25.80	0649223	242	210.00
0633155	236	516.00	0637122	244	25.80	0656303	243	50.00
0633174	236	208.00	0637123	244	27.00	0656304	243	75.00
0633175	236	245.00	0637124	244	28.00	0656305	243	893.00
0633176	236	386.00	0637125	244	28.00	0656306	243	983.00
0633177	236	458.00	0637126	244	28.00	0656309	243	57.00
0633182	236	162.00	0637127	244	29.50	0656310	243	50.00
0633214	239	432.00	0637128	244	30.10	0656311	243	50.00
0633216	239	341.00	0637129	244	31.10	0656312	243	50.00
0633218	239	233.00	0637130	244	31.10	0656313	243	49.20
0633220	239	154.00	0637131	244	32.30	0656314	243	47.90
0633805	237	339.00	0637132	244	33.60	0656315	243	47.90
0633808	237	453.00	0637133	244	33.60	0656316	243	47.90
0633810	237	275.00	0637134	244	34.60	0656317	243	47.90
0633833	72	563.00	0637135	244	34.60	0656318	243	47.90
0633834	72	751.00	0637136	244	38.30	0656319	243	49.20
0633836	72	1341.00	0637137	244	39.00	0656320	243	50.00
0633838	72	2371.00	0637138	244	40.10	0656321	243	51.00
0636301	241	812.00	0637139	244	40.10	0656322	243	51.00
0636321	241	246.00	0637140	244	41.10	0656323	243	52.00
0636322	241	246.00	0637141	244	41.90	0656324	243	52.00
0636323	241	304.00	0637142	244	43.10	0656325	243	53.00
0636324	241	304.00	0637144	244	44.40	0656326	243	53.00
0636325	241	304.00	0637146	244	45.70	0656327	243	54.00
0636326	241	371.00	0637147	244	56.00	0656328	243	56.00
0636327	241	371.00	0637148	244	49.20	0656329	243	56.00
0636328	241	371.00	0637149	244	50.00	0656330	243	56.00
0636329	241	371.00	0637150	244	51.00	0656331	243	59.00
0636341	241	1034.00	0637151	244	53.00	0656332	243	60.00
0636342	241	1034.00	0637152	244	54.00	0656333	243	61.00
0636343	241	1310.00	0637154	244	56.00	0656334	243	63.00
0636344	241	1310.00	0637155	244	59.00	0656335	243	63.00
0636345	241	1310.00	0637156	244	63.00	0656336	243	64.00
0636346	241	1612.00	0637157	244	67.00	0656337	243	59.00
0636347	241	1612.00	0637158	244	69.00	0656338	243	67.00
0636348	241	1612.00	0637159	244	73.00	0656339	243	67.00
0636349	241	1612.00	0637160	244	73.00	0656340	243	68.00
0636351	241	1321.00	0637161	244	80.00	0656341	243	68.00
0636352	241	1200.00	0637162	244	81.00	0656342	243	69.00
0636372	241	723.00	0637163	244	83.00	0656343	243	71.00
0636373	241	723.00	0637164	244	88.00	0656344	243	72.00
0636374	241	952.00	0637165	244	92.00	0656345	243	73.00
0636375	241	952.00	0637166	244	93.00	0656346	243	77.00
0636376	241	952.00	0637167	244	95.00	0656347	243	81.00
0636377	241	1153.00	0637168	244	99.00	0656348	243	83.00
0636378	241	1308.00	0637169	244	104.00	0656349	243	85.00
0636379	241	1308.00	0637170	244	105.00	0656350	243	88.00
0636380	241	1308.00	0637171	244	108.00	0656351	243	90.00

Order number index



Order no.	Page	List price in €	Order no.	Page	List price in €	Order no.	Page	List price in €
0656352	243	93.00	0658690	247	252.00	0710163	25	6.50
0656353	243	95.00	0691731	116	378.00	0710164	125	6.50
0656354	243	104.00	0691733	116	433.00	0710165	125	8.20
0656355	243	108.00	0691735	116	943.00	0710166	25	5.90
0656356	243	113.00	0691737	116	1063.00	0710167	25	4.10
0656357	243	116.00	0691741	116	467.00	0710168	126	4.10
0656358	243	123.00	0691743	116	512.00	0710169	126	8.20
0656359	243	132.00	0691745	116	1045.00	0710170	126	8.20
0656360	243	137.00	0691747	116	1207.00	0710171	126	8.20
0656361	243	142.00	0691751	116	543.00	0710172	126	8.20
0656362	243	146.00	0691753	116	600.00	0710173	126	8.20
0656363	243	154.00	0700100	120	67.00	0710174	126	8.20
0656364	243	159.00	0700101	120	67.00	0710175	126	8.20
0656365	243	168.00	0700102	120	51.00	0710176	126	8.20
0656366	243	179.00	0700104	120	59.00	0710177	25	8.20
0656367	243	191.00	0701101	117	44.60	0710178	126	8.20
0656368	243	197.00	0701102	117	56.00	0710179	126	8.20
0656369	243	205.00	0701103	118	24.00	0710180	126	8.20
0656370	243	219.00	0701106	118	25.00	0710181	127	8.20
0656371	243	229.00	0701110	118	41.70	0710182	127	8.20
0656372	243	237.00	0701111	118	47.90	0710183	127	8.20
0656373	243	248.00	0702106	120	68.00	0710184	127	8.20
0656374	243	261.00	0703101	118	110.00	0710185	127	8.20
0656375	243	272.00	0703104	118	153.00	0710186	127	8.20
0656376	243	284.00	0703107	118	307.00	0710187	127	8.20
0656377	243	297.00	0704105	119	78.00	0710188	127	8.20
0656378	243	307.00	0704106	119	96.00	0710189	127	8.20
0656379	243	320.00	0704109	119	126.00	0710192	127	10.10
0656380	243	331.00	0704110	119	163.00	0710193	127	4.30
0656381	243	343.00	0705102	121	121.00	0710194	127	5.90
0656382	243	355.00	0705104	121	121.00	0710195	128	1.50
0656383	243	388.00	0705105	121	126.00	0710196	128	11.10
0656384	243	419.00	0705107	121	128.00	0710197	128	1.30
0656385	243	450.00	0705109	121	156.00	0710261	125	29.80
0656386	243	483.00	0706102	121	78.00	0710262	125	48.00
0656387	243	516.00	0707101	119	138.00	0710263	125	75.00
0656388	243	547.00	0707102	119	118.00	0710264	125	56.00
0656389	243	580.00	0708101	117	96.00	0710265	125	25.80
0656390	243	611.00	0708102	117	61.00	0710267	126	13.70
0656391	243	644.00	0708103	117	74.00	0710268	126	13.70
0656392	243	675.00	0708104	117	50.00	0710292	127	71.00
0656393	243	712.00	0708105	117	61.00	0710297	128	5.70
0656394	243	743.00	0708106	117	81.00	0710367	126	10.70
0656395	243	778.00	0709101	122	116.00	0710368	126	10.70
0656396	243	813.00	0709108	122	138.00	0710397	128	8.00
0656397	243	848.00	0710101	123	53.00	0710467	126	10.70
0656398	243	883.00	0710102	123	6.60	0710468	126	10.70
0656399	243	916.00	0710103	123	6.80	0710497	128	8.00
0658009	246	68.00	0710104	123	10.50	0712121	122	155.00
0658011	246	64.00	0710105	123	10.50	0712124	122	190.00
0658012	246	63.00	0710111	124	4.50	0715101	129	80.00
0658013	246	60.00	0710112	124	4.50	0715103	129	90.00
0658015	246	63.00	0710113	124	4.50	0715201	129	126.00
0658017	246	67.00	0710114	124	4.50	0715303	129	113.00
0658019	246	72.00	0710115	124	4.50	0715305	129	107.00
0658090	246	252.00	0710116	124	4.50	0715307	129	160.00
0658509	246	53.00	0710117	124	4.50	0715903	129	12.10
0658511	246	49.20	0710118	124	4.50	0715907	129	12.10
0658512	246	49.20	0710119	124	4.50	0715915	129	16.90
0658513	246	49.20	0710120	124	4.50	0715917	129	13.30
0658515	246	50.00	0710121	124	4.50	0715919	129	13.30
0658517	246	59.00	0710122	124	4.50	0715921	129	18.70
0658519	246	69.00	0710123	124	4.50	0715922	129	14.10
0658590	247	252.00	0710124	124	4.50	0715923	129	14.00
0658609	247	53.00	0710125	124	4.50	0715925	129	17.10
0658611	247	49.20	0710126	124	4.50	0715926	129	13.30
0658612	247	49.20	0710127	124	4.50	0715929	129	13.30
0658613	247	49.20	0710128	124	4.50	0715940	130	2.50
0658615	247	50.00	0710129	124	4.50	0715950	130	25.30
0658617	247	59.00	0710161	25	4.30	0715955	130	16.00
0658619	247	69.00	0710162	125	5.60	0716101	131	140.00

Order number index



Order no.	Page	List price in €	Order no.	Page	List price in €	Order no.	Page	List price in €
0716102	131	204.00	0750601	145	25.10	0806504	77	43.90
0716105	131	183.00	0752101	146	144.00	0806513	77	160.00
0716111	131	270.00	0752103	146	184.00	0806521	78	46.00
0716192	131	59.00	0753110	144	24.90	0806522	78	74.00
0716194	131	73.00	0753120	144	61.00	0806523	78	91.00
0716196	131	94.00	0754101	147	99.00	0806524	78	105.00
0716198	131	125.00	0756101	147	59.00	0806525	78	143.00
0720103	132	243.00	0763100	150	279.00	0806526	78	160.00
0724101	124	59.00	0770102	148	208.00	0806527	78	178.00
0728105	133	415.00	0770103	148	241.00	0806528	78	196.00
0728106	133	403.00	0770201	148	266.00	0806540	78	275.00
0728107	133	461.00	0770205	148	377.00	0806542	78	605.00
0728108	133	643.00	0772024	149	759.00	0807101	76	56.00
0728109	133	927.00	0780001	155	376.00	0810501	79	276.00
0728110	133	2188.00	0780002	155	417.00	0810502	79	292.00
0728201	133	1057.00	0780003	155	649.00	0810503	79	307.00
0728202	133	756.00	0780021	154	109.00	0810504	79	325.00
0728203	133	705.00	0780023	154	139.00	0815510	79	291.00
0728204	133	489.00	0780032	155	199.00	0815514	79	307.00
0728205	133	495.00	0780033	155	275.00	0815518	79	383.00
0728206	133	471.00	0780042	155	193.00	0815530	79	330.00
0728207	133	551.00	0780043	155	261.00	0815534	79	487.00
0728208	133	717.00	0780072	154	129.00	0815540	79	538.00
0728209	133	949.00	0780073	154	235.00	0816501	80	348.00
0728210	133	2240.00	0780074	154	259.00	0816502	80	393.00
0728910	133	1307.00	0780091	155	380.00	0816503	80	453.00
0728915	133	1296.00	0780092	155	427.00	0816504	80	517.00
0728920	133	1875.00	0780093	155	879.00	0816505	80	589.00
0735101	134	408.00	0780094	155	909.00	0816506	80	664.00
0735102	134	368.00	0780101	151	605.00	0816507	80	938.00
0735103	134	427.00	0780102	151	768.00	0816508	80	991.00
0735901	134	225.00	0780104	151	692.00	0816509	80	1053.00
0735902	134	187.00	0780105	151	788.00	0816510	80	1130.00
0739102	135	1780.00	0780107	151	1984.00	0816511	80	1219.00
0739121	137	91.00	0780108	151	2212.00	0816512	80	1304.00
0739122	137	103.00	0780141	154	2116.00	0817512	81	1120.00
0739123	137	94.00	0780142	154	2395.00	0817514	81	1165.00
0739124	136	107.00	0780174	151	49.00	0817516	81	1304.00
0739125	136	111.00	0780175	151	39.00	0817518	81	1480.00
0739126	136	64.00	0780177	151	125.00	0817520	81	1655.00
0739127	136	102.00	0780178	151	115.00	0817522	81	1836.00
0739128	136	64.00	0780201	152	559.00	0817524	81	2021.00
0739129	136	123.00	0780202	152	699.00	0817526	81	2236.00
0739130	136	103.00	0780206	152	1400.00	0819501	82	184.00
0739131	136	111.00	0780301	153	529.00	0819502	82	205.00
0739132	136	148.00	0780302	153	669.00	0819503	82	227.00
0739164	137	38.60	0780306	153	1340.00	0819505	82	259.00
0739165	137	47.60	0782160	156	706.00	0819510	82	249.00
0739170	137	279.00	0782181	156	225.00	0819511	82	314.00
0741101	139	1862.00	0782191	156	1172.00	0819512	82	357.00
0741112	139	259.00	0783012	156	3545.00	0819513	82	412.00
0741114	139	275.00	0783070	156	296.00	0819514	82	508.00
0741116	139	420.00	0784108	157	3101.00	0819515	82	585.00
0741122	142	270.00	0784181	157	625.00	0819516	82	671.00
0741124	142	324.00	0784190	157	175.00	0819517	82	758.00
0741132	142	88.00	0785108	149	639.00	0819519	82	1408.00
0741134	143	152.00	0785109	149	1565.00	0819521	82	1516.00
0741136	142	251.00	0785110	149	1800.00	0819523	82	1786.00
0741170	139	171.00	0788104	158	1131.00	0819525	82	2052.00
0741172	141	204.00	0788180	158	229.00	0819527	82	2360.00
0741174	141	167.00	0788904	159	900.00	0822301	89	95.00
0741176	141	115.00	0788980	159	73.00	0822302	89	144.00
0741178	140	115.00	0788990	159	326.00	0822303	89	265.00
0741179	140	115.00	0800501	76	18.90	0822304	89	433.00
0741180	140	115.00	0800502	76	22.90	0824302	89	194.00
0741182	140	191.00	0800503	76	26.30	0824303	89	196.00
0741184	143	649.00	0800504	76	31.10	0849501	88	737.00
0750102	145	187.00	0800513	76	110.00	0849502	88	876.00
0750112	145	109.00	0806501	77	34.10	0850511	88	582.00
0750113	145	42.00	0806502	77	37.30	0850512	88	646.00
0750122	145	96.00	0806503	77	40.60	0850514	88	687.00

Order number index



Order no.	Page	List price in €	Order no.	Page	List price in €	Order no.	Page	List price in €
0850516	88	734.00	0870955	93	318.00	0894854	99	904.00
0850518	88	768.00	0882300	107	293.00	0894872	99	938.00
0854301	90	257.00	0882301	107	319.00	0898101	91	11.40
0854302	90	312.00	0882303	107	350.00	0898102	91	19.10
0854303	90	334.00	0882304	107	410.00	0898103	91	22.60
0854304	90	363.00	0882306	107	660.00	0898104	91	25.80
0855301	90	185.00	0884501	96	885.00	0898105	91	29.90
0855302	90	227.00	0885501	96	183.00	0898106	91	42.30
0855303	90	257.00	0885502	96	203.00	0898107	91	47.30
0855304	90	272.00	0885503	96	213.00	0898108	91	52.00
0864321	95	330.00	0885504	96	255.00	0898109	91	57.00
0864322	95	396.00	0885505	96	324.00	0898110	91	63.00
0864323	95	429.00	0885506	96	374.00	0898111	91	67.00
0864324	95	466.00	0885507	96	476.00	0898112	91	83.00
0864325	95	503.00	0885508	96	540.00	0898113	91	90.00
0864326	95	539.00	0886503	107	24.40	0898114	91	96.00
0864327	95	579.00	0886505	107	28.10	0898115	91	102.00
0864328	95	619.00	0886507	107	24.40	0898116	91	109.00
0870301	92	328.00	0886513	107	43.30	0898117	91	116.00
0870302	92	343.00	0888101	97	55.00	0898118	91	122.00
0870303	92	369.00	0888501	97	171.00	0898119	91	128.00
0870304	92	403.00	0888502	97	171.00	0898120	91	135.00
0870305	92	442.00	0888503	97	171.00	0898121	91	142.00
0870306	92	480.00	0888504	97	179.00	0898122	91	149.00
0870307	92	685.00	0888505	97	185.00	0898123	91	156.00
0870309	92	748.00	0888506	97	207.00	0898124	91	164.00
0870311	92	823.00	0888507	97	212.00	0898125	91	171.00
0870801	94	78.00	0888508	97	219.00	0898126	91	177.00
0870802	94	79.00	0888509	97	228.00	0898127	91	184.00
0870803	94	80.00	0888510	97	234.00	0898128	91	192.00
0870804	94	81.00	0888511	97	241.00	0898132	91	221.00
0870805	94	82.00	0888512	97	249.00	0898136	91	249.00
0870807	94	91.00	0888513	97	259.00	0898140	91	277.00
0870809	94	103.00	0888514	97	269.00	0898142	91	290.00
0870811	94	113.00	0888515	97	275.00	0898146	91	318.00
0870821	94	78.00	0888516	97	287.00	0898150	91	349.00
0870822	94	79.00	0888517	97	293.00	0898154	91	376.00
0870823	94	80.00	0888518	97	304.00	0898158	91	405.00
0870824	94	86.00	0888519	97	314.00	0898162	91	649.00
0870825	94	87.00	0888520	97	321.00	0912501	83	81.00
0870827	94	100.00	0888521	97	328.00	0912502	83	92.00
0870829	94	114.00	0890511	95	69.00	0912503	83	105.00
0870831	94	131.00	0892332	98	79.00	0912504	83	120.00
0870841	94	170.00	0892333	98	80.00	0912505	83	132.00
0870842	94	175.00	0892334	98	89.00	0912506	83	145.00
0870843	94	180.00	0892336	98	109.00	0912507	83	156.00
0870844	94	187.00	0892339	98	144.00	0912508	83	168.00
0870845	94	203.00	0892340	98	203.00	0912521	83	435.00
0870847	94	242.00	0892501	98	419.00	0996701	251	77.00
0870849	94	295.00	0892502	98	514.00	0996705	251	147.00
0870851	94	362.00	0892503	98	633.00	1271451	65	89.00
0870901	93	124.00	0892504	98	798.00	1271452	65	103.00
0870903	93	107.00	0892505	98	1013.00	1271455	65	59.00
0870905	93	107.00	0894504	99	249.00	1276590	66	33.00
0870907	93	107.00	0894510	99	663.00	1276591	66	18.80
0870909	93	107.00	0894514	99	895.00	1276592	66	18.00
0870911	93	124.00	0894518	99	1156.00	1276593	66	25.00
0870921	93	135.00	0894522	99	1423.00	1278912	70	114.00
0870923	93	117.00	0894526	99	1464.00	1279780	68	114.00
0870925	93	117.00	0894530	99	1717.00	1279781	68	114.00
0870927	93	117.00	0894534	99	1763.00	1279782	68	114.00
0870929	93	117.00	0894538	99	3078.00	1279783	68	114.00
0870931	93	117.00	0894542	99	4015.00	1279784	68	114.00
0870933	93	135.00	0894546	99	4984.00	1279785	68	114.00
0870941	93	318.00	0894550	99	5921.00	1320416	21	115.00
0870943	93	231.00	0894554	99	6859.00	1320417	21	115.00
0870945	93	203.00	0894804	99	179.00	1320516	21	145.00
0870947	93	203.00	0894806	99	203.00	1320517	21	145.00
0870949	93	203.00	0894810	99	219.00	1320518	21	395.00
0870951	93	203.00	0894820	99	242.00	1320519	21	185.00
0870953	93	231.00	0894834	99	275.00	1320522	21	235.00

Order number index



Order no.	Page	List price in €	Order no.	Page	List price in €	Order no.	Page	List price in €
1326416	22	159.00	1360722	59	419.00	1921524	100	493.00
1326417	22	159.00	1360728	59	481.00	1921526	100	493.00
1326418	22	225.00	1360734	59	1370.00	1921528	100	568.00
1326422	22	285.00	1360738	59	2090.00	1921530	100	585.00
1326516	23	159.00	1362722	60	429.00	1921532	100	601.00
1326517	23	159.00	1362728	60	499.00	1921534	100	617.00
1326518	23	235.00	1364722	61	406.00	1921536	100	866.00
1326904	30	573.00	1364728	61	452.00	1921538	100	1023.00
1326906	31	568.00	1366718	62	422.00	1921540	100	1077.00
1326908	30	489.00	1366722	62	510.00	1921542	100	1137.00
1326910	31	562.00	1366728	62	642.00	1922510	106	302.00
1326912	27	320.00	1368722	63	429.00	1922512	106	302.00
1326914	22	343.00	1368728	63	489.00	1922514	106	307.00
1326916	28	396.00	1371416	65	388.00	1922516	106	307.00
1326918	26	503.00	1371418	65	426.00	1922518	106	318.00
1326920	27	545.00	1371422	65	475.00	1922520	106	328.00
1326922	28	447.00	1371428	65	547.00	1922522	106	339.00
1326924	29	443.00	1375502	69	249.00	1922524	106	380.00
1326928	29	476.00	1376514	66	517.00	1922526	106	380.00
1326930	26	653.00	1378505	70	788.00	1922528	106	453.00
1326932	25	359.00	1378508	70	848.00	1922530	106	464.00
1326990	25	39.00	1379722	67	663.00	1922532	106	479.00
1330522	38	398.00	1379728	67	914.00	1922534	106	495.00
1330528	38	607.00	1379790	67	8.90	1922536	106	724.00
1330532	38	992.00	1722502	110	142.00	1922538	106	880.00
1330534	38	1200.00	1723502	110	179.00	1922540	106	953.00
1331522	38	462.00	1724502	110	296.00	1922542	106	985.00
1331528	38	681.00	1726502	111	345.00	1923100	103	797.00
1331532	38	1049.00	1726506	111	380.00	1923200	103	797.00
1331534	38	1206.00	1726510	111	669.00	1923300	103	797.00
1334522	39	369.00	1726514	111	828.00	1923510	102	1099.00
1334528	39	518.00	1728502	111	289.00	1923512	102	1099.00
1334532	39	905.00	1728506	111	368.00	1923514	102	1110.00
1334534	39	1071.00	1728510	111	600.00	1923516	102	1110.00
1335522	39	422.00	1728514	111	768.00	1923518	102	1157.00
1335528	39	596.00	1730502	112	382.00	1923520	102	1177.00
1335532	39	973.00	1730506	112	431.00	1923522	102	1188.00
1335534	39	1118.00	1734502	113	397.00	1923524	102	1240.00
1338522	45	475.00	1734506	113	455.00	1923526	102	1245.00
1340522	40	431.00	1734522	114	515.00	1923528	102	1339.00
1340528	40	822.00	1739910	111	40.00	1923530	102	1370.00
1340532	40	1110.00	1739920	110	14.90	1923532	102	1401.00
1340534	40	1365.00	1866210	87	175.00	1923534	102	1454.00
1341522	40	488.00	1866410	84	207.00	1923536	102	1766.00
1341528	40	878.00	1866413	84	270.00	1923538	102	1975.00
1341532	40	1165.00	1866417	84	343.00	1923540	102	2126.00
1341534	40	1420.00	1866420	84	391.00	1923542	102	2308.00
1342522	41	396.00	1866510	84	249.00	1923574	103	1771.00
1342528	41	731.00	1866513	84	299.00	1923576	103	1563.00
1342532	41	1012.00	1866517	84	389.00	1923578	103	2292.00
1342534	41	1259.00	1866520	84	435.00	1923580	103	2813.00
1343522	41	452.00	1866521	87	1360.00	1924100	105	500.00
1343528	41	788.00	1866610	86	339.00	1924190	105	79.00
1343532	41	1068.00	1866613	86	389.00	1924200	105	500.00
1343534	41	1314.00	1866617	86	489.00	1924300	105	584.00
1348722	24	607.00	1866620	86	529.00	1924510	104	818.00
1348728	24	778.00	1920574	101	1126.00	1924512	104	818.00
1351522	44	554.00	1920576	101	790.00	1924514	104	828.00
1351528	44	717.00	1920578	101	1949.00	1924516	104	839.00
1351622	44	591.00	1920580	101	2328.00	1924518	104	870.00
1351628	44	784.00	1920910	101	92.00	1924520	104	870.00
1351920	47	499.00	1920914	101	98.00	1924522	104	901.00
1352516	51	388.00	1920920	101	103.00	1924524	104	948.00
1352517	51	437.00	1920924	101	124.00	1924526	104	953.00
1352518	51	800.00	1921510	100	398.00	1924528	104	1037.00
1352520	51	900.00	1921512	100	398.00	1924530	104	1078.00
1352522	51	939.00	1921514	100	398.00	1924532	104	1115.00
1353522	49	491.00	1921516	100	398.00	1924534	104	1167.00
1354520	47	590.00	1921518	100	422.00	1924536	104	1438.00
1360716	59	329.00	1921520	100	433.00	1924538	104	1657.00
1360718	59	373.00	1921522	100	439.00	1924540	104	1771.00

Order number index



Order no.	Page	List price in €	Order no.	Page	List price in €
1924542	104	1980.00	4351638	258	120.00
1924574	105	1459.00	4352412	258	15.30
1924576	105	1250.00	4352418	258	24.40
1924578	105	2084.00	4352422	258	46.10
1924580	105	2709.00	4353410	258	56.00
1997501	250	50.00	4353510	258	78.00
1998501	250	64.00	4357010	258	11.60
1998710	250	0.00	4357020	258	34.10
1998720	250	72.00	4357610	258	11.80
1998722	251	60.00	4357620	258	20.10
1998730	251	120.00	4358410	259	17.70
1998732	251	72.00	4358420	259	31.20
1998740	251	101.00	4358810	259	20.10
1998742	251	363.00	4359210	259	25.50
1998744	251	363.00	4359410	259	32.70
1998746	251	497.00	4360210	257	26.10
1998748	251	497.00	4360212	257	37.40
1998760	171	147.00	4360214	257	42.40
1998770	111	5.90	4360218	257	55.00
1998780	252	95.00	4360810	259	36.20
1998801	250	98.00	4361410	259	55.00
1998802	250	85.00	4380110	256	35.70
4310110	256	12.40	4380112	256	49.00
4310115	256	22.10	4380114	256	88.00
4310120	256	37.40	4380120	256	35.40
4310125	256	79.00	4380122	256	48.00
4310130	256	109.00	4380124	256	88.00
4310135	256	171.00	4380130	256	46.50
4320210	256	21.00	4380132	256	73.00
4320212	256	28.30	4380134	256	89.00
4320214	256	30.80	4380140	256	44.50
4320220	256	34.10	4380142	256	48.40
4320224	256	45.00	4380149	256	91.00
4320228	256	62.00	4380150	257	54.00
4320810	256	132.00	4380151	257	58.00
4320814	256	188.00	4380152	257	68.00
4320818	256	201.00	4380154	257	78.00
4320822	256	206.00	4380156	257	110.00
4320826	256	206.00	4380160	257	70.00
4320830	256	206.00	4380170	257	83.00
4320834	256	263.00	018550105	10	26.00
4320838	256	263.00	018550505	10	34.50
4320842	256	263.00	019650105	12	25.10
4320846	256	263.00	019650116	12	25.10
4320850	256	312.00	019650516	12	35.90
4320854	256	312.00	026552005	37	270.00
4320858	256	373.00	026652005	37	362.00
4320862	256	373.00	132641660	20	218.00
4320866	256	373.00	132641760	20	218.00
4322810	257	46.90	132641860	20	279.00
4322814	257	93.00	132642260	20	337.00
4322818	257	115.00	137141660	64	432.00
4329010	256	7.50	137141860	64	459.00
4329026	256	17.20	137142260	64	516.00
4329046	256	34.30	137142860	64	585.00
4340210	258	16.10	172650260	115	391.00
4340214	258	17.70	172650660	115	425.00
4340218	258	26.10	173450260	115	441.00
4340222	258	44.60	173450660	115	497.00
4340226	258	54.00	186641060	85	259.00
4340230	258	79.00	186641360	85	319.00
4342410	257	12.40	186641760	85	389.00
4342610	257	28.30	186642060	85	435.00
4350210	258	32.30	186642160	87	1390.00
4350218	258	53.00	186661060	86	349.00
4350226	258	79.00	186661360	86	399.00
4350232	258	103.00	186661760	86	499.00
4350238	258	144.00	186662060	86	539.00
4351610	258	27.00			
4351618	258	63.00			
4351628	258	94.00			



0 - 9

	Page
3 point internal micrometers, analogue	101-106
3 point internal measuring pistol, digital	104,106
3 point internal micrometers, digital	102,103

A

Acute angle squares 45°	187
Adjustable squares	189
Adjustable V-blocks	213
Alpha square	188
Aluminium straight edges	199
Angle lever attachment	124
Angle normal 90°	179

B

Base stand for inspection plates	207
Batteries for electronic devices	21, 83, 111
Bench centres & accessories	151-157
Bevel protractors	192-195
Blade micrometers	90
Brake disc inspection gauges	50
Brake drum vernier calipers	50

C

Cable for data transmission	250
Calibration service	256-259
Calipers for 3/5 point measurement	52
Calipers for external locking grooves, analogue & digital	49
Calipers for internal grooves, analogue & digital	51
Calipers with cross points, digital	44
Calipers with gripper points analogue & digital	37, 47
Calipers with integrated Wireless	20
Calipers, analogue	10-17, 32-37
Calipers, digital	18-31,38-51,59-71
Carbide gauge block sets	238,239
Carpenters squares	188
Centre squares	185
Chamfer gauge	223
Combined internal / external calipers	167
Compact measuring stands	148
Concentricity measuring gauge with disc supports	157
Connecting cables for electronic instruments	250
Convertor mm/inch	219
Crankshaft gauges	134
Cutting gauges	216,217

D

Data acquisition / data transmission	250-253
Data cables	250
DBP weld seam gauge	222
Depth attachment base for pocket calipers	22
Depth gauge, digital, with interchangeable inserts	67
Depth gauges with integrated wireless	64
Depth gauges, digital	59-70
Depth measuring base for indicators	131
Depth micrometers	107
Depthgauge, digital, for one-hand operation	70
Dial calipers	17
Dial comparator gauges »MICROTAST«	122
Dial depth gauges with a measuring base	131
Dial gauges, analogue	117-122
Dial gauges, shockproof	119, 121
Dial gauges, small	117
Dial gauges, water and oil proof	119
Dial gauges, with concentric mm-display	120
Dial gauges, with extended measuring range	118
Dial gauges, with reverse action plunger	122
Dial micrometers	88
Dial test indicators and accessories	129

Dial thickness gauges	132
Digital pocket calipers	20-31
Digital pocket calipers for specific measuring tasks	26-31
DIN thread conversion	219
Disc micrometers	89
Dividers	163
Double V-blocks	208-212
Drill and steel wire hole gauges	225
Duo-Fix pocket vernier caliper	14

E

Extension depth attachment base for depth gauges	65, 68
Extensions for dial gauges	124

F

Feeler gauge tapes	228, 229
Feeler gauge tapes INOX	228
Feeler gauges	226, 227
Filetor ISO thread convertor	219
Flange squares	185
Flexible steel rules	198,199
Frame levels	215

G

Gauge block holders	236
Gauge block inspection sets for micrometers and calipers	237
Gauge block maintenance set	237
Gauge blocks	233-239
Gear tooth calipers	54

H

Height and scribing gauges	170
Height and scribing gauges, digital	171, 172
Holder for external micrometers	76
Holder for feeler gauge tapes	228
Holder for internal micrometers	97

I

Indicators	110-116
Indicators with integrated wireless	115
Inspection plates	206
Inspection set for micrometers and calipers	237
Inspection square set	184
Inspection squares, hardened	177
Integrated Wireless caliper	20
Integrated Wireless Indicators	115
Integrated Wireless micrometers	86, 86
Interchangeable inserts for depth caliper	68
Interior circumference tapes	201
Internal calipers	164
Internal micrometer digital	102,103
Internal micrometers with interchangeable extensions	98
Internal micrometers with measuring jaws	96
Internal micrometers, cylindrical version	97
Internal precision bore gauges	133
i-Stick receiver for intergated wireless	252

K

Knife edge rule	205
Knife edge squares, hardened	183

L

Lapping and inspection plate	207
Levels	215
Lightweight workshop calipers, analogue & digital	36, 46
Lug back	123



M	Page		Page
Machine levels with V-groove	215	Steel rules	202-204
Magnetic angle gauge	216	Steel rules, flexible	198, 199
Magnetic back	123	Steel scale tapes for circumference and diameter	201
Magnetic measuring and clamping prism	212, 213	Steel square	180
Marking calipers	168	Straight edges with bevelled edge	202
Marking gauges	167	Surface roughness standards	232
Measuring and inspection plates	206		
Measuring heads	106	T	
Measuring inserts	125 - 128	Tapered hole gauges	223
Measuring stands	148, 149	Tapes for circumference and diameter	201
Micrometers for thread flank measurement	92	Thread cutting gauges	216, 217
Micrometers for tube wall measurement	89	Thread flank inserts for external measurement	93
Micrometers with DataVariable	84	Thread flank setting standards for external measurement	94
Micrometers with DataVariable, linear	86	Thread plug gauges, individual and set	246
Micrometers with integrated wireless	85	Thread ring gauges, individual and set	246, 247
Micrometers with integrated wireless, linear	86	Tolerator ISO tolerance convertor	219
Micrometers with reduced measuring faces	90	Twist drill grinding gauges	220
Micrometers, external, analogue	76 - 82	Tyre profile depth gauge	16
Micrometers, external, digital	83 - 85		
Micrometers, external, with exchangeable anvils	81	U	
Micrometers, external, with interchangeable inserts	82	UHTAST comparator gauge & accessories	138-143
Milling tool caliper	52	Universal bevel protractors, analogue & digital	194,195
Mitre squares	186	Universal calipers, digital, Pocket-Talent	24,25
Mounting scales, digital	71	Universal comparator gauge & accessories	135-137
		Universal grinding gauge	221
N		Universal indicator stands & magnetic base & accessories	144,145
Nozzle gauges	224	Universal magnetic holder	147
		Universal measuring support	150
P			
Parallel blocks, set	214	V	
Pin gauge holder	240	V-blocks	208-212
Pin gauges, set	241	Vernier depth gauges	55-58
Plane parallel jaws	236		
Plug gauges, individual and set	244	W	
Pocket calipers	20 - 31	Wall holders with feelergauge tape sets	228
Pocket vernier caliper »Duo-Fix«	14	Welding gauges	221
Pocket vernier caliper, for lefthanded	15	Wire thickness micrometer	95
Pocket vernier calipers	14-21	Wireless data transmission	252
Pocket vernier calipers, parallax-free reading	13	Wooden cases	73
POCKET-TALENT	25	Workshop calipers, analogue	32-36
Precision feeler gauge tapes	228, 229	Workshop calipers, analogue, long measuring jaws	34
Precision reference sheets	230	Workshop calipers, digital	38-46
Profile gauge	220	Workshop calipers, parallax-free reading	35
Protractors	191		
		X	
R		X type V-blocks (parallel)	209
Radius gauge	223		
Radiused measuring jaws	236		
Ring gauges	243		
Roller supports for bench centre	155		
S			
Screw pitch gauges	226		
Scribers	163, 165		
Set of 3 point internal micrometers, analogue	101		
Set of 3 point internal micrometers, measuring pistol	106		
Set of external micrometers, analogue	76,77		
Setting device for internal precision bore gauges	133		
Setting standards for micrometers	91		
Small depth gauge, digital	69		
Snap gauges, double jaw	242		
Software for data acquisition	250		
Spring dividers	180		
Squares with base	176 - 182		
Squares with hard and slim blade	182		
Squares without base	176 - 179		
Stand for gaugeblock holders	236		
Steel gauge block, sets	238, 239		



A series of horizontal lines for writing, organized into two columns. Each column contains 20 lines, for a total of 40 lines on the page.



A large area of the page is filled with horizontal lines, organized into two columns. Each column contains 20 lines, providing a space for handwritten notes.



A large area of the page is filled with horizontal lines, organized into two columns. Each column contains 20 lines, providing a space for handwritten notes.



A series of horizontal lines forming a grid for notes, consisting of two columns of lines.



HELIOS · PREISSER

THE TRADE SPECIALISTS



**SQUARES
OUT OF THIS WORLD**